

Features

- MoCA Compliant Front-End GaAs IC
- Linear Power Amplifier
- Integrated PA Bias Control
- Transmit/Receive Switch
- Transmit Power Detector
- 0/3/6 dB Transmit Attenuator
- 0/15 dB Receive Attenuator
- 3.3 Volt Single Bias
- Integrated Digital Control Logic
- Compatible with EN2510 & EN2511
- Lead-free 3 mm 16-lead PQFN Package
- RoHS* Compliant
- 75 Ω Characteristic Impedance

Description

The XZ1003-QT is an integrated front end GaAs IC for MoCA High-band RF applications which is fully compatible with Entropic Communications chipset. It is housed in an industry standard 3 mm PQFN package and operates from a single 3.3 V bias. The chip includes a power amplifier, transmit/receive switch, power detector, switched attenuators, bias circuits and digital control circuitry. The transmit path includes two 3 dB switched attenuators and a power detector for gain adjustment and linearity optimization. A switched attenuator in the receiver provides a 15 dB gain step. The integrated bias circuit stabilizes transmit amplifier performance over temperature and process variation with optional bias adjustment. The device typically delivers 20 dBm at P1dB and +32 dBm OIP3 across the operating temperature range. The digital inputs control all circuit operating modes and are compatible with Entropic's MoCA chipsets.

Ordering Information^{1,2}

Part Number	Package
XZ1003-QT-0G0T	Tape and Reel
XZ1003-QT-EV1	Sample Test Board

1. Reference Application Note M513 for reel size information.
2. All sample boards include 5 loose parts.

* Restrictions on Hazardous Substances, European Union Directive 2011/65/EU.

Functional Block Diagram

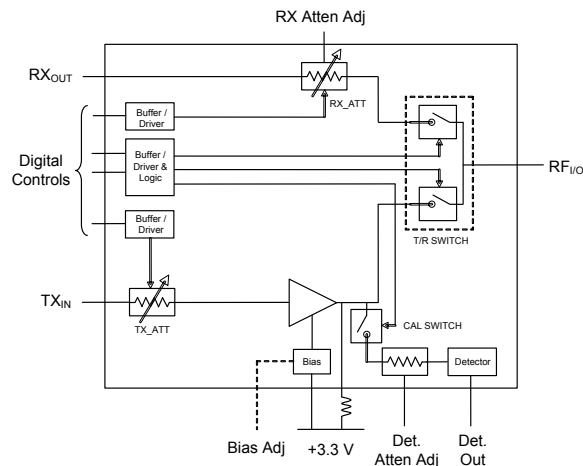

Pin Configuration

Pin No.	Function	Pin No.	Function
1	RX_ATT	9	TX_ATT1
2	TX_RX	10	N/C
3	CAL	11	I_O
4	TX_IN	12	DET_ATT
5	BIAS_ADJ	13	VD3
6	VD2	14	VDET
7	VD1	15	RX_OUT
8	TX_ATT2	16	RX_ADJ
		17	Paddle ³

3. The exposed pad centered on the package bottom must be connected to RF and DC ground.

Pin Description

Pin No.	Pin Name	Function
1	RX_ATT	Digital input. A logic high input voltage enables the 15 dB receive attenuator.
2	TX_RX	Digital input. A logic high voltage selects transmit mode, logic low selects receive mode.
3	CAL	Digital input. A logic high selects calibration mode (transmit amplifier output is diverted into the power detector). This pin overrides the TX_RX control input.
4	TX_IN	Transmit RF input (75 Ω).
5	BIAS_ADJ	Bias adjustment of transmit amplifier using pull-up/down resistor.
6	VD2	Bias supply.
7	VD1	Bias supply.
8	TX_ATT2	Digital input. Refer to digital control specification table.
9	TX_ATT1	Digital input. Refer to digital control specification table.
10	N/C	No Connection
11	I_O	RF input in the receive mode and RF output in the transmit mode (75 Ω).
12	DET_ATT	External RC network connected to this pin sets the power detector sensitivity.
13	VD3	Detector bias supply.
14	VDET	Power detector output voltage. Used during calibration mode to measure output power.
15	RX_OUT	Receive RF output (75 Ω).
16	RX_ADJ	External RC network connected to this pin sets the receive attenuator gain step.

Evaluation Board Layout

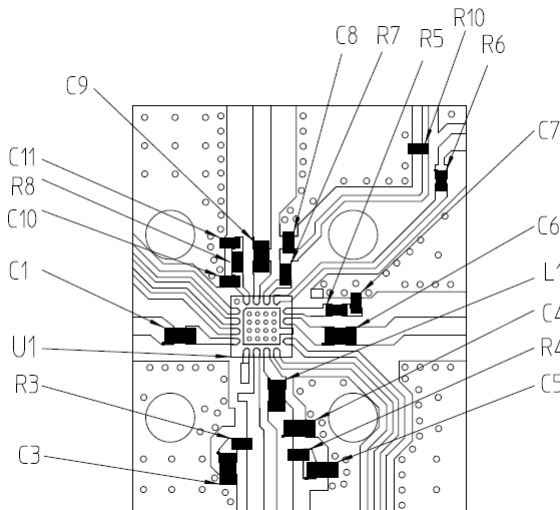

Component Values

Component	Value	Package
R3	10 Ω	0402
R4	2.2 Ω	0402
R5	200 Ω	0402
R6	0 Ω	0402
R7	2 k Ω	0402
R8	22.1 Ω	0402
R10	100 k Ω	0603
L1	33 nH	0603
C1, C6, C9	47 pF	0603
C3, C5	0.1 μ F	0603
C4	33 pF	0603
C7	5.6 pF	0402
C8	270 pF	0402
C10	6.8 pF	0402
C11	18 pF	0402

Evaluation Board Schematic

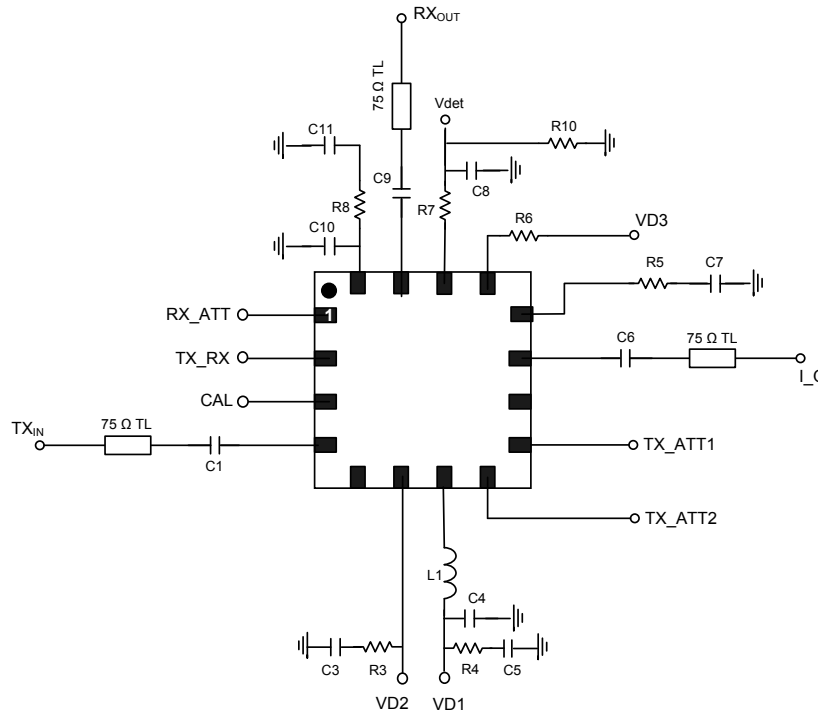

DC Specifications

Parameter	Units	Min.	Typ.	Max.
Supply Voltage (V_{DD})	V	3.13	3.3	3.47
Supply Current (I_{DD})	mA	—	180	235
Supply Current (I_{D1})	mA	—	160	—
Supply Current (I_{D2})	mA	—	12	—
Supply Current (I_{D3})	mA	—	2.2	—
Supply Current (I_{bias_adj})	mA	—	2.5	—
Logic Low (L)	V	-0.5	0	0.2
Logic High (H)	V	1.2	3.3	3.47
Logic Low Current	mA	-0.5	—	1
Logic High Current	mA	-0.5	—	1

Absolute Maximum Ratings^{4,5}

Parameter	Absolute Max.
Supply Voltage (V_{DD}) to Ground	+7 V
V_{DD} to any other V_{DD}	+7 V
All other pins to ground	+6 V
Power Dissipation (P_{diss})	.825 W
Operating Temperature (T_a)	-40°C to +85°C
Operating Humidity Range	0% to 95% non-condensing
Storage Temperature (T_{stg})	-55°C to +150°C
Storage Humidity Range	0% to 100% non-condensing
Junction Temperature	150°C
Thermal Resistance, Junction to case ⁶	43°C/W
ESD (HBM)	Class 0
ESD (HBM), I_O, TX_IN & RX_OUT	Class 1A
Lead Temperature (soldering)	Refer to App Note S2083
RF Input Power @ pin 4 (TX_IN)	10 dBm
RF Input Power @ pin 11 (I_O)	20 dBm

4. Exceeding any one or combination of these limits may cause permanent damage to this device.

5. MACOM does not recommend sustained operation above these survivability limits.

6. Thermal Resistance is calculated using XZ1003-QT-EV1 evaluation sample board.

4

Digital Control Specifications

Operating Mode	Control Inputs				
	CAL	TX_RX	TX_ATT1	TX_ATT2	RX_ATT
TX Gain 1 (0 dB attenuation), GT1	L	H	H	H	L/H
TX Gain 2 (3 dB attenuation), GT2	L	H	L	H	L/H
TX Gain 3 (6 dB attenuation), GT3	L	H	L	L	L/H
CAL	H	L/H	L/H	L/H	L/H
RX Gain 1 (0 dB attenuation), GR1	L	L	L/H	L/H	L
RX Gain 2 (15 dB attenuation), GR2	L	L	L/H	L/H	H

Receive Specifications:

Freq = 775 - 1525 MHz, $T_A = -40^{\circ}\text{C}$ to $+85^{\circ}\text{C}$, $V_{DD} = 3.13 - 3.47\text{ V}$, $Z_0 = 75\ \Omega$

Parameter	Test Conditions	Units	Min.	Typ.	Max.
Receive Gain 1	(RX_ATT = L)	dB	-1.4	-0.95	—
Receive Gain 2	(RX_ATT = H)	dB	-16.7	-15.6	-14.5
Receive Gain Step Difference	Gain 1, Gain 2	dB	14.2	14.8	15.7
Pass Band Ripple	Over Any 50 MHz	dB	—	0.5	—
RX Switch Time	50% Control to 10/90% RF, Gain 1 or 2 to Gain 2 or 1	ns	—	—	100
TX/RX Switch Time	50% Control to 10/90% RF, Receive Mode TX_RX = L; Transmit Mode TX_RX = H	ns	—	—	100
Noise Figure	Exclusive of Receive Added Noise Gain 1 Gain 2	dB	—	1.15 16.5	1.67 17.6
Receive Added Noise	Noise Contribution of PA Output to RX_OUT In RX Mode 775 - 1275 MHz 1276 - 1525 MHz	dBm/Hz	—	—	-177 -174
Input Return Loss	—	dB	11	13	—
Output Return Loss	—	dB	11	13	—
Input Third Order Intercept Point	RX Power In = 0 dBm, 10 MHz spacing Gain 1, Gain 2	dBm	28	30	—
Input P1dB	Gain 1, Gain 2	dBm	15	—	—

Transmit Specifications:

Freq = 775 - 1525 MHz, T_A = -40°C to +85°C, V_{DD} = 3.13 - 3.47 V, Z₀ = 75 Ω

Parameter	Test Conditions	Units	Min.	Typ.	Max.
Transmit Gain 1 (TX_ATT1 = H) (TX_ATT2 = H)	-40°C to +85°C	dB	15.1	16.8	19.1
Transmit Gain 2 (TX_ATT1 = L) (TX_ATT2 = H)	-40°C to +85°C	dB	11.8	13.7	15.9
Transmit Gain 3 (TX_ATT1 = L) (TX_ATT2 = L)	-40°C to +85°C	dB	8.6	10.7	12.7
Transmit Gain Step Difference	Gain 1 - Gain 2 or Gain 2 - Gain 3 Gain 1 - Gain 3	dB	2.4 5.2	3.2 6.3	3.7 6.8
Transmit Gain Drift vs. Temperature	-40°C to +85°C TX1, TX2, TX3	dB	—	—	2.5
Switch Time	50% Control to 10/90% RF, TX1 ↔ TX2 ↔ TX3	ns	—	—	100
Pass Band Ripple	Over Any 50 MHz	dB	—	0.5	—
Input Return Loss	0.9 GHz - >1.4 GHz 0.775 - >0.9; 1.4 - > 1.525 GHz	dB	11 7	13 9	—
Output Return Loss	≥1.4 GHz ≤1.4 GHz	dB	7 10	12 13	—
Output Third Order Intercept Point	TX Power Out =+ 5 dBm, 10 MHz spacing -40°C +25°C +85°C	dBm	30.4 29.7 28	34 32 30	—
Output P1dB	-40°C +25°C +85°C	dBm	18.9 18.2 17.5	21 20.4 19.6	—

Transmit Specifications, (cont.):

Freq = 775 - 1525 MHz, T_A = -40°C to +85°C, V_{DD} = 3.13 - 3.47 V, Z₀ = 75 Ω

Parameter	Test Conditions	Units	Min.	Typ.	Max.
PA Output to RX Output Isolation	TX Mode (TX_RX=H; CAL=L; RX_ATT=L) Calibration Mode (CAL=H)	dB	16 25	19.5 30	32 37
PA Output to I_O Isolation	Calibration Mode (CAL=H)	dB	16	17.5	—
Power Detector Min Output Voltage (No TX Output Power)	Detector Output Load 100 kΩ -40°C +25°C +85°C	mV	392 416 436	402 454 503	—
Power Detector CW Output Voltage	Detector Output Load 100 kΩ, 775 & 1525 MHz only TX Power Out = +3.3 dBm, +25°C & 3.3 V TX Power Out = +7.0 dBm, +25°C & 3.3 V	mV	602 711	635 759	668 807
Power Detector Delta Voltage	Detector Output Load 100 kΩ, 775 & 1525 MHz only TX Power Out = +3.3 dBm, +25°C & 3.3 V TX Power Out = +7.0 dBm, +25°C & 3.3 V	mV	201 303	237 357	258 389
Power Detector Video Bandwidth	—	MHz	—	50	—
Power Detector Switch Time	Detector Output Load 100 kΩ 50% Cal Control to 10/90% RF	ns	—	—	100
Noise Figure	Gain 1 Gain 2 Gain 3	dB	—	—	6.0 9.5 12.0
Spurious (2nd Harmonics)	TX Power Out = +9 dBm	dBm	—	—	-26
Spurious (All Others)	TX Power Out = +9 dBm	dBm	—	—	-51

Typical Performance Curves Receive Path (RX)

Gain - RX1

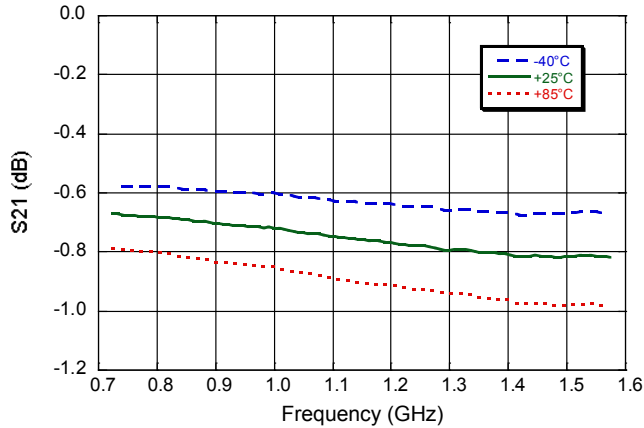

Gain - RX2

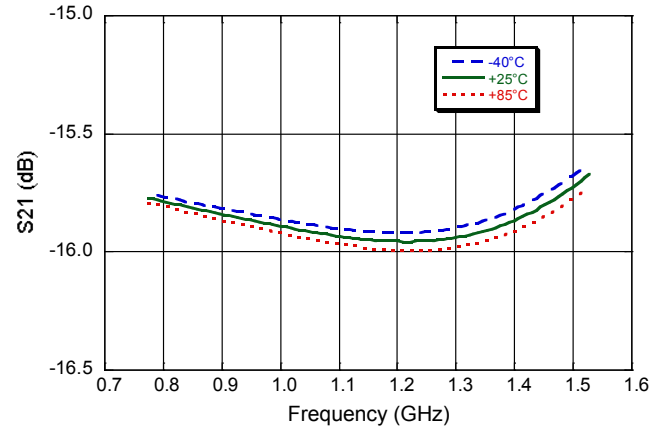

Gain - Step Difference

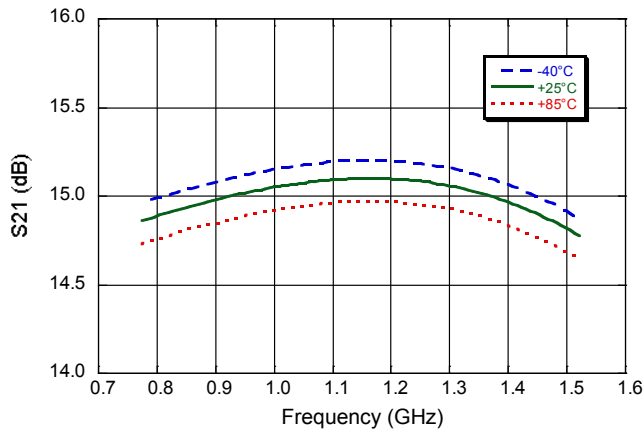

Input Return Loss

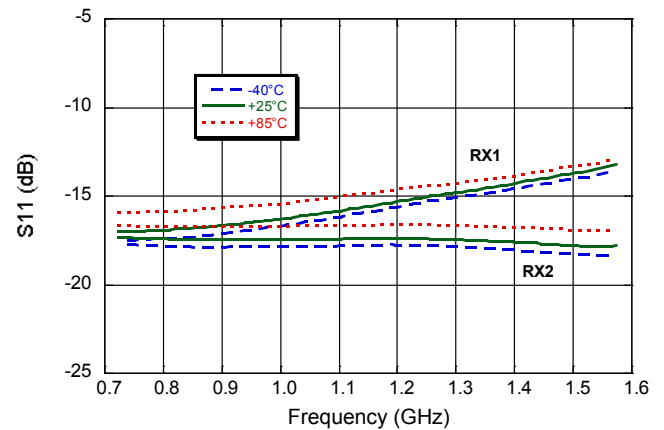

Output Return Loss

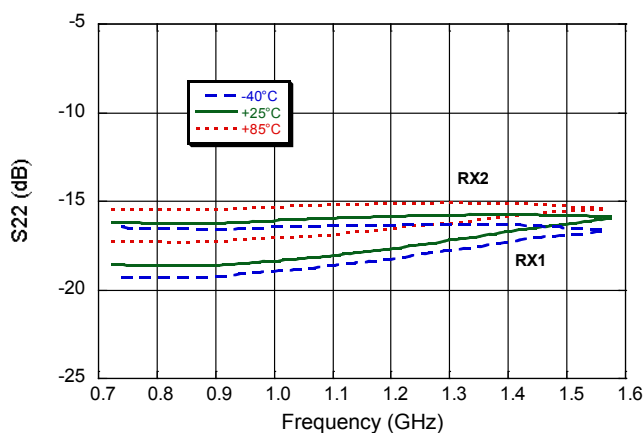

Noise Figure

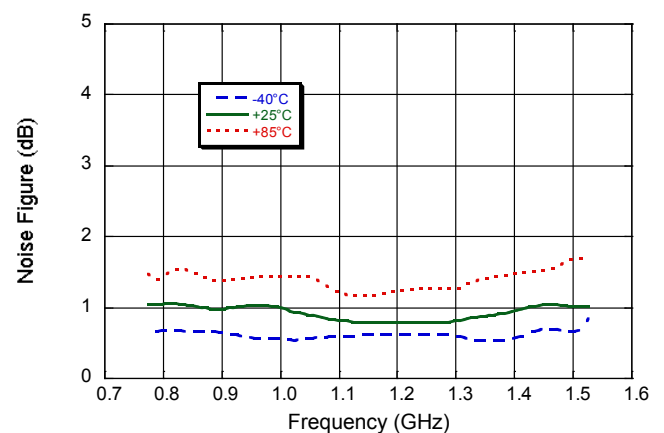

Typical Performance Curves Transmit Path (TX)

Gain

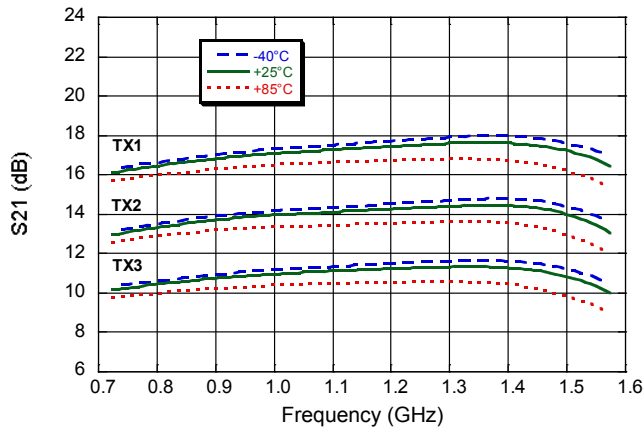

Gain - Step Difference

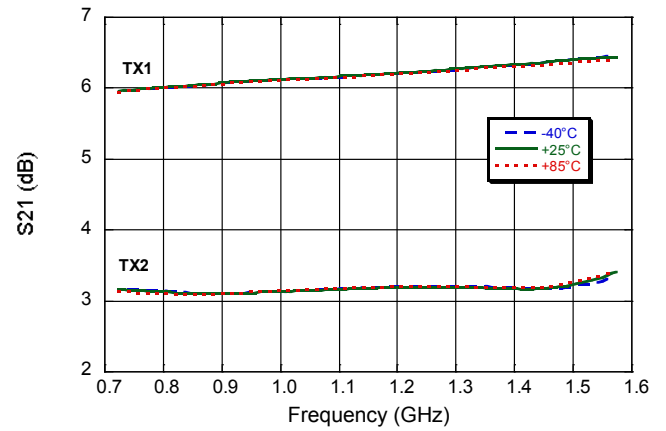

Input Return Loss

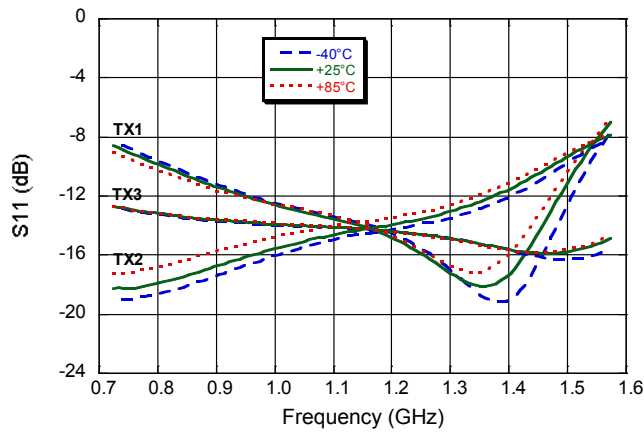

Output Return Loss

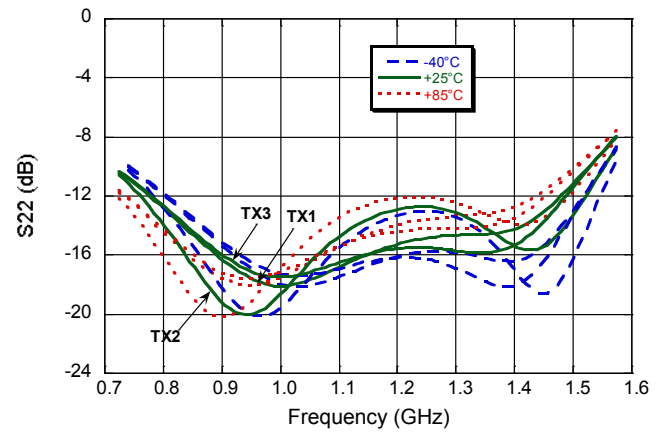

Voltage Detector @ 775 MHz

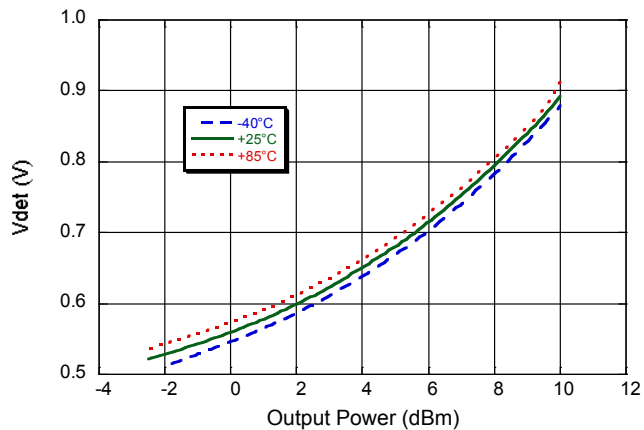

Voltage Detector @ 1525 MHz

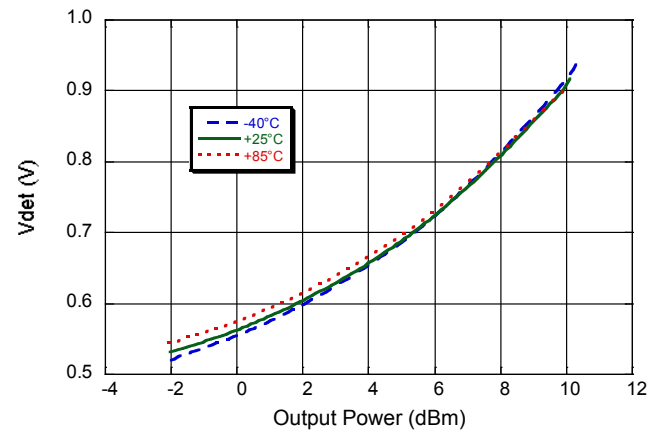

Typical Performance Curves Transmit Path (TX)

Gain_TX1 (0.775 - 1.525 GHz)

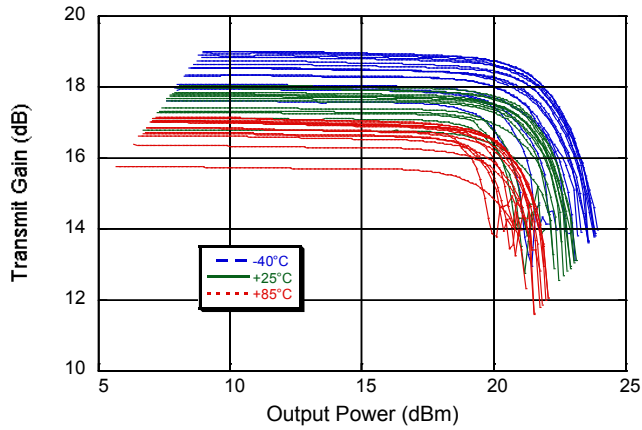

P1dB_TX1, TX2, or TX3

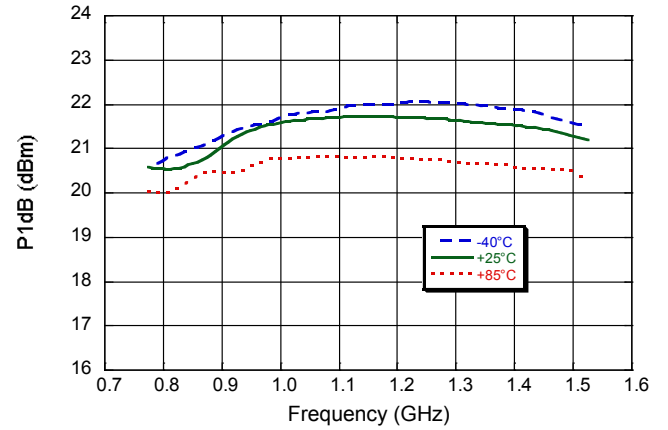

Output IP3_TX1, TX2, or TX3

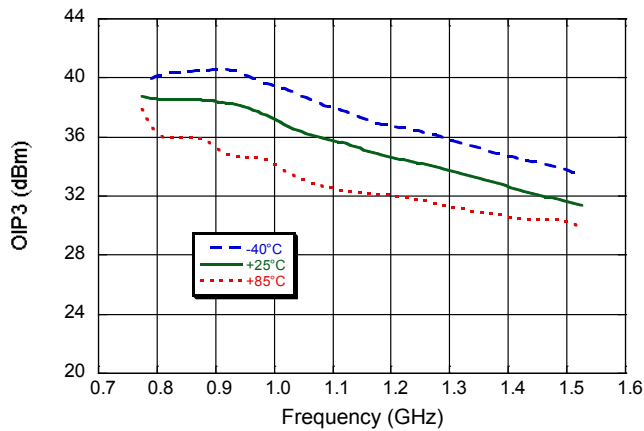

Typical Performance Curves

Isolation PA to RX in TX Mode

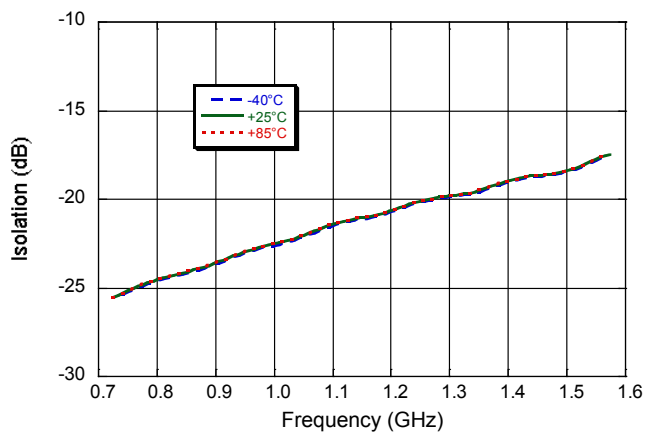

Isolation PA to RX in CAL Mode

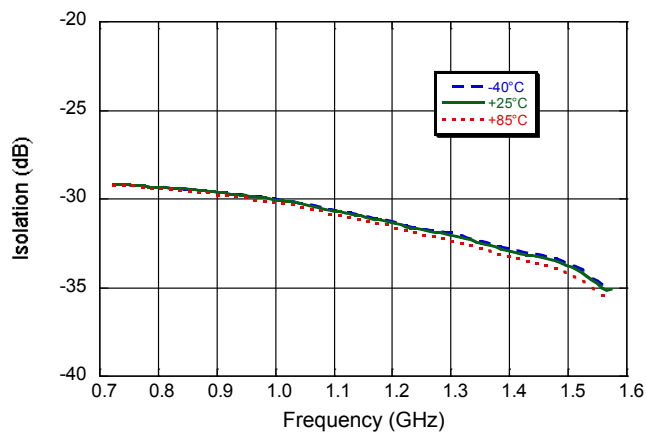

Isolation PA to IO in CAL Mode

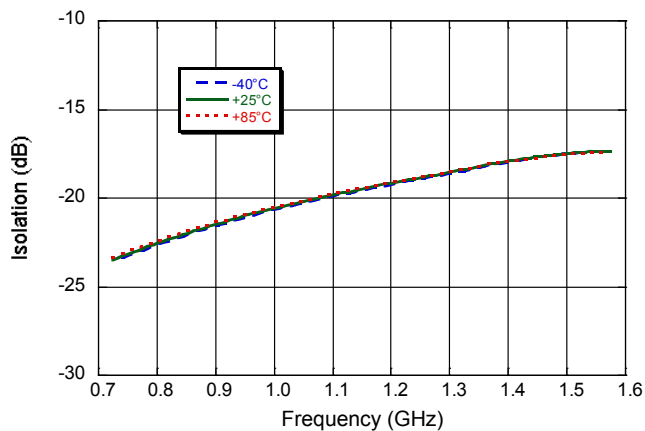

PCB Land Pattern

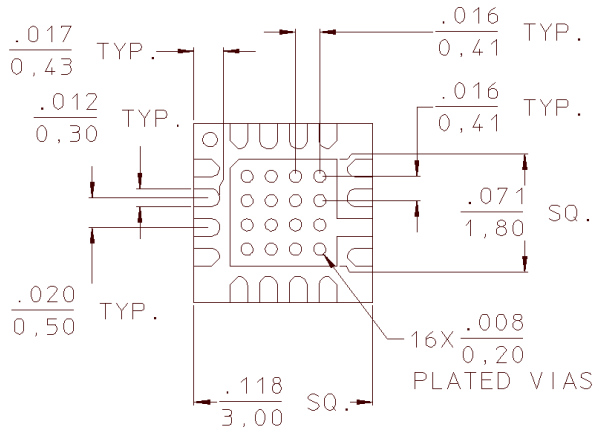

Handling Procedures

Please observe the following precautions to avoid damage:

Static Sensitivity

Gallium Arsenide Integrated Circuits are sensitive to electrostatic discharge (ESD) and can be damaged by static electricity. Proper ESD control techniques should be used when handling these devices.

Lead-Free 3mm 16-Lead PQFN†

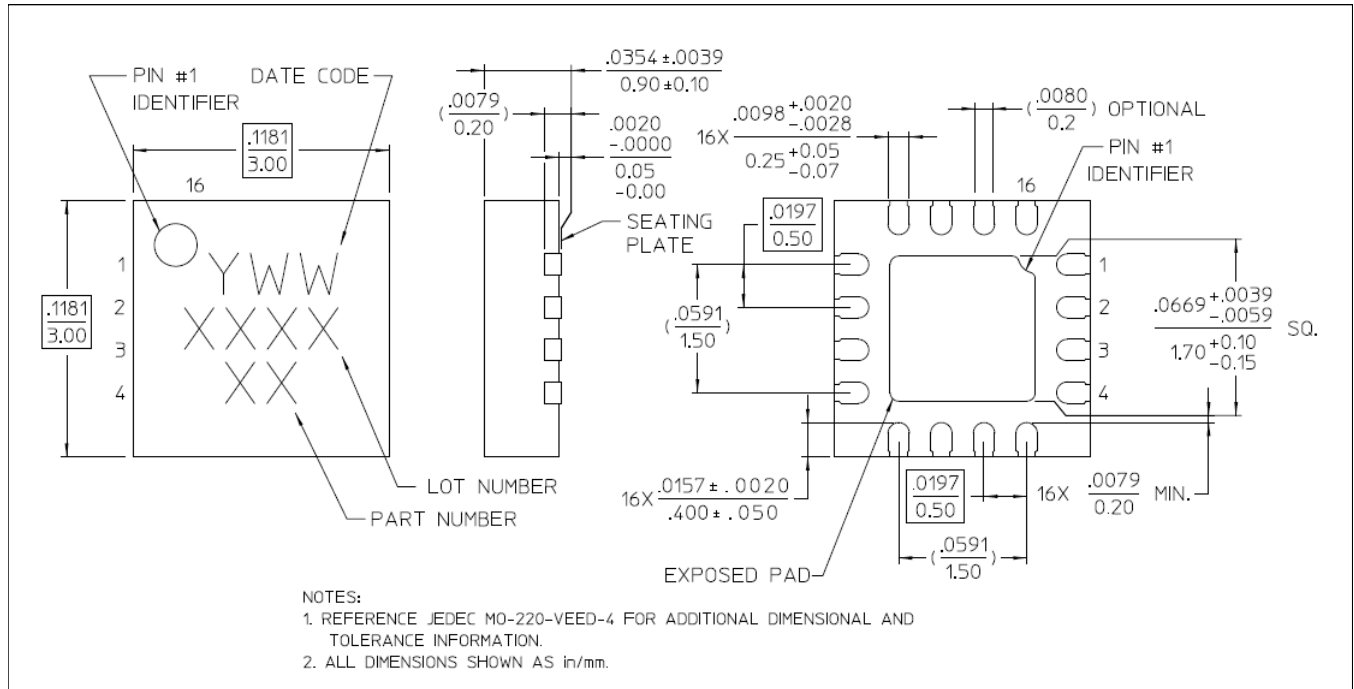

† Reference Application Note S2083 for lead-free solder reflow recommendations and PCB footprint information.
Meets JEDEC moisture sensitivity level 1 requirements.
Plating is 100% matte tin over copper.

M/A-COM Technology Solutions Inc. All rights reserved.

Information in this document is provided in connection with M/A-COM Technology Solutions Inc ("MACOM") products. These materials are provided by MACOM as a service to its customers and may be used for informational purposes only. Except as provided in MACOM's Terms and Conditions of Sale for such products or in any separate agreement related to this document, MACOM assumes no liability whatsoever. MACOM assumes no responsibility for errors or omissions in these materials. MACOM may make changes to specifications and product descriptions at any time, without notice. MACOM makes no commitment to update the information and shall have no responsibility whatsoever for conflicts or incompatibilities arising from future changes to its specifications and product descriptions. No license, express or implied, by estoppel or otherwise, to any intellectual property rights is granted by this document.

THESE MATERIALS ARE PROVIDED "AS IS" WITHOUT WARRANTY OF ANY KIND, EITHER EXPRESS OR IMPLIED, RELATING TO SALE AND/OR USE OF MACOM PRODUCTS INCLUDING LIABILITY OR WARRANTIES RELATING TO FITNESS FOR A PARTICULAR PURPOSE, CONSEQUENTIAL OR INCIDENTAL DAMAGES, MERCHANTABILITY, OR INFRINGEMENT OF ANY PATENT, COPYRIGHT OR OTHER INTELLECTUAL PROPERTY RIGHT. MACOM FURTHER DOES NOT WARRANT THE ACCURACY OR COMPLETENESS OF THE INFORMATION, TEXT, GRAPHICS OR OTHER ITEMS CONTAINED WITHIN THESE MATERIALS. MACOM SHALL NOT BE LIABLE FOR ANY SPECIAL, INDIRECT, INCIDENTAL, OR CONSEQUENTIAL DAMAGES, INCLUDING WITHOUT LIMITATION, LOST REVENUES OR LOST PROFITS, WHICH MAY RESULT FROM THE USE OF THESE MATERIALS.

MACOM products are not intended for use in medical, lifesaving or life sustaining applications. MACOM customers using or selling MACOM products for use in such applications do so at their own risk and agree to fully indemnify MACOM for any damages resulting from such improper use or sale.