

Features

- Integrated LNA, Mixer and LO Buffer Amplifier
- 1.8 dB Noise Figure
- 13 dB Conversion Gain
- Lead-Free 4 mm 24-lead QFN Package
- 100% RF, DC and NF Testing
- RoHS* Compliant and 260°C Reflow Compatible

Description

The XR1011-QH is a 4.5 - 10.5 GHz QFN packaged receiver that has a noise figure of 1.8 dB and 13 dB conversion gain across the band. The device integrates an LNA, image reject mixer and LO buffer amplifier within a fully molded 4 mm QFN package. The image reject mixer eliminates the need for a band pass filter after the LNA to remove thermal noise at the image frequency. I and Q mixer outputs are provided and an external 90° hybrid is required to select the desired sideband. This device uses MACOM device model technology, and is based upon electron beam lithography to ensure high repeatability and uniformity.

This device is specifically designed for Point to Point radio applications and is well suited for other telecom applications such as SATCOM and VSAT.

Ordering Information¹

Part Number	Package
XR1011-QH-0GPO	bulk quantity
XR1011-QH-0GPT	tape and reel
XR1011-QH-EV1	evaluation module

1. Reference Application Note M513 for reel size information.

Functional Schematic

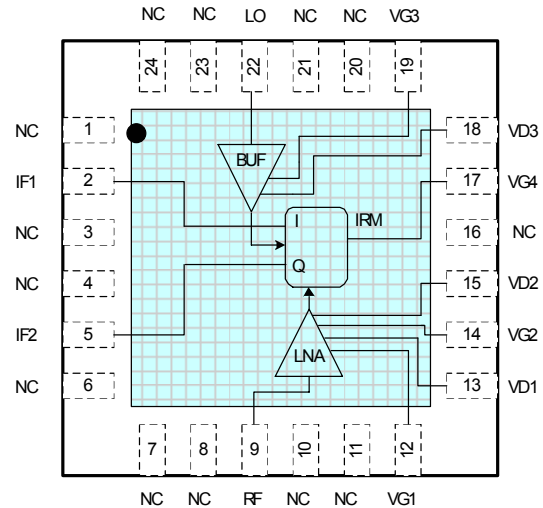

Pin Configuration^{2,3}

Pin #	Pin Name	Function
2	IF1	IF1 Output
5	IF2	IF2 Output
9	RF	RF Input
12	VG1	Gate 1 Bias
13	VD1	Drain 1 Bias
14	VG2	Gate 2 Bias
15	VD2	Drain 2 Bias
17	VG4	Gate 4 Bias
18	VD3	Drain 3 Bias
19	VG3	Gate 3 Bias
22	LO	LO Input
1,3,4,6,7,8,10,11,16,20,21,23,24	NC	Not Connected

2. The exposed pad centered on the package bottom must be connected to RF and DC ground.
3. It is recommended to externally ground all N/C pins.

* Restrictions on Hazardous Substances, European Union Directive 2011/65/EU.

Receiver
4.5 - 10.5 GHz

Rev. V2

Electrical Specifications: RF/LO Frequency = 4.5 - 10.5 GHz, T_A = +25°C

Parameter	Units	Min.	Typ.	Max.
IF Frequency Range	GHz	DC	—	3.5
Conversion Gain	dB	12	13	15
Noise Figure	dB	—	1.8	—
Input Third Order Intercept	dBm	—	+3	—
Image Rejection	dBc	15	20	—
LO Input Drive	dBm	—	+5	—
LO/RF Isolation	dB	—	-50	—
RF Input Return Loss	dB	—	10	—
LO Input Return Loss	dB	—	10	—
IF Return Loss	dB	—	10	—
Drain Bias Voltage 1,2,3	VDC	—	+4	+4
Gate Bias Voltage 1,2,3 ⁴	VDC	-1.2	-0.3	0.2
Gate Bias Voltage 4 ⁵	VDC	—	-2	—
Supply Current 1	mA	—	25	—
Supply Current 2	mA	—	45	—
Supply Current 3	mA	—	60	—
Supply Current 4	mA	—	2	—

4. V_G1,2 and 3 are adjusted to achieve constant drain current regulation.

5. V_G4 provides mixer bias and is fixed at -2 V.

Absolute Maximum Ratings^{6,7}

Parameter	Absolute Max.
Supply Voltage	+4.3 V
Supply Current	180 mA
Gate Bias Voltage	-3 V
Power Dissipation	750 mW
RF Input Power	+14 dBm
LO Input Power	+15 dBm
Operating Temperature	-55°C to +85°C
Storage Temperature	-65°C to +150°C
Channel Temperature	-40°C to MTTF Graph
MSL Level	MSL3

6. Operation of this device above any one of these parameters may cause permanent damage.

7. Channel temperature directly affects a device's MTTF. Channel temperature should be kept as low as possible to maximize lifetime.

Handling Procedures

Please observe the following precautions to avoid damage:

Static Sensitivity

Integrated Circuits are sensitive to electrostatic discharge (ESD) and can be damaged by static electricity. Proper ESD control techniques should be used when handling these HBM Class 1A, MM Class A devices.

Typical Performance Curves

XR1011-QH: USB Conversion Gain (dB)
4V @130mA, PLO=5dBm

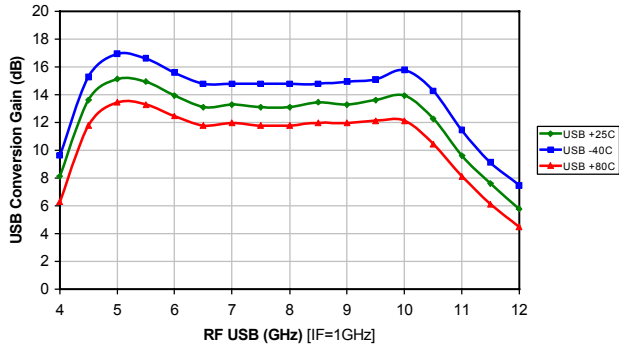

XR1011-QH: USB Conversion Gain (dB)
4V @130mA, PLO=5dBm

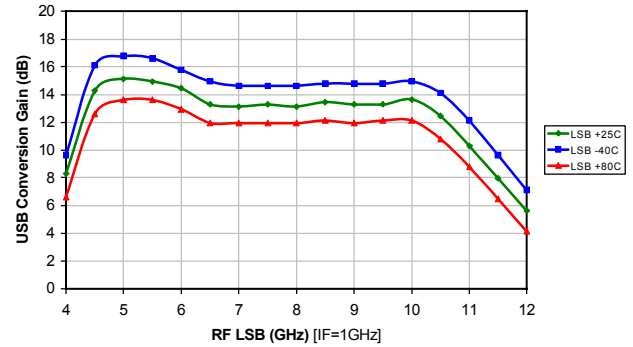

XR1011-QH: USB Noise Figure
4V @130mA, PLO=5dBm

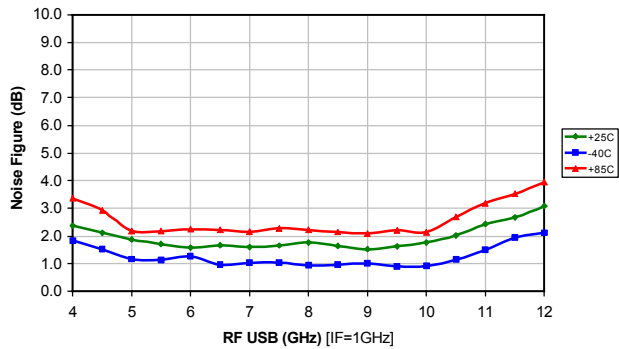

XR1011-QH: USB Noise Figure
4V @130mA, PLO=5dBm

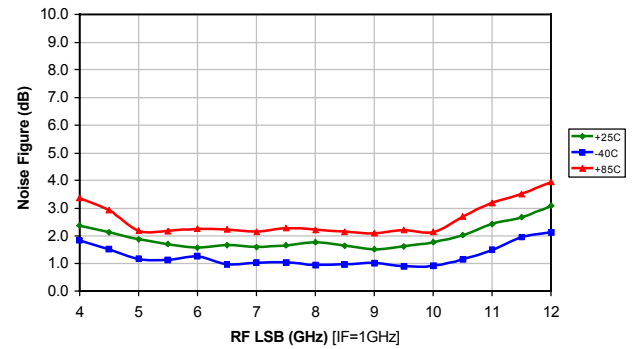

XR1011-QH: USB IIP3 (dBm)
4V @130mA, PLO=5dBm, RF = -18 dBm per Tone

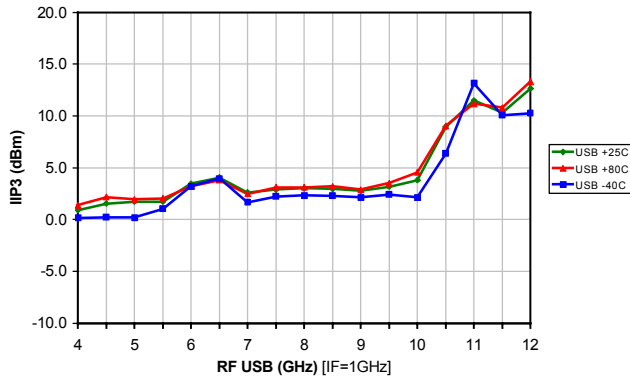

XR1011-QH: LSB IIP3 (dBm)
4V @130mA, PLO=5dBm, RF = -18 dBm per Tone

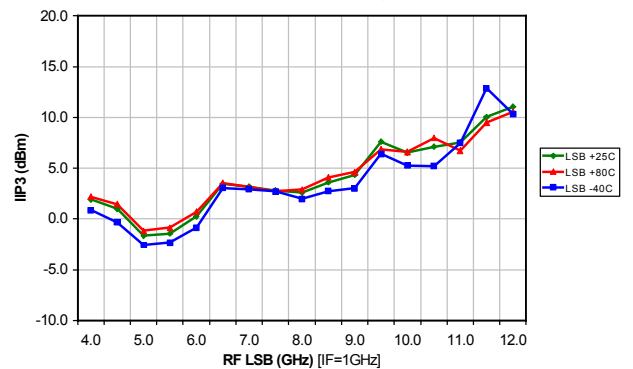

Typical Performance Curves

XR1011-QH: USB and LSB Image Rejection (dBc)
4V @ 130mA, PLO=5dBm

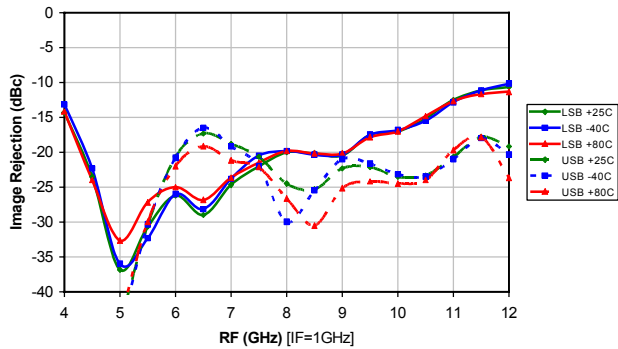

XR1011-QH: Conversion Gain (dB) vs IF (GHz) at LO=7.5 GHz
4V @ 130mA, PLO=5dBm

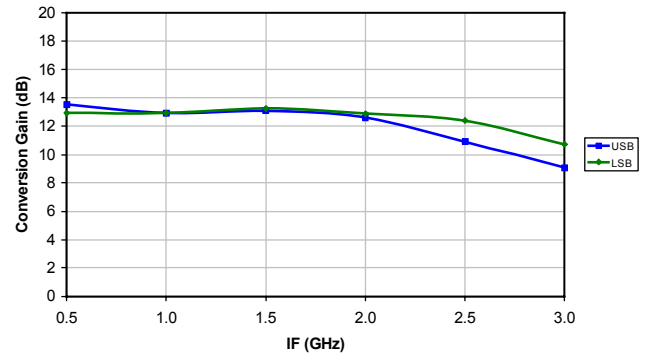

XR1011-QH: Noise Figure (dB) vs IF (GHz) at LO=7.5 GHz
4V @ 130mA, PLO=5dBm

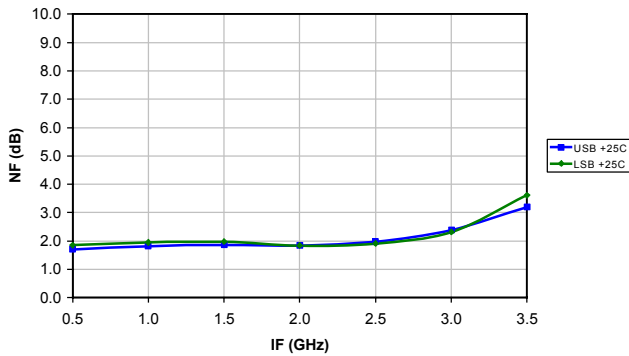

XR1011-QH: LSB Conversion Gain (dB) vs. RF (GHz).
4 V @ 130 mA

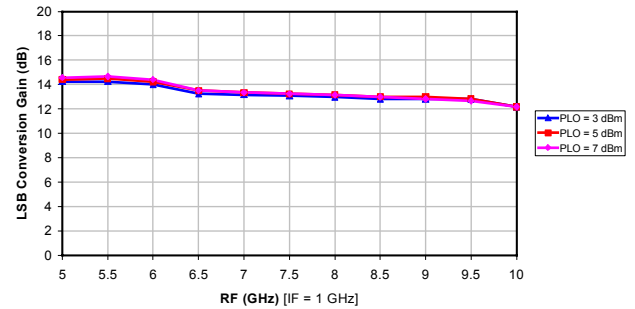

XR1011-QH: USB Conversion Gain (dB) vs. RF (GHz).
4 V @ 130 mA

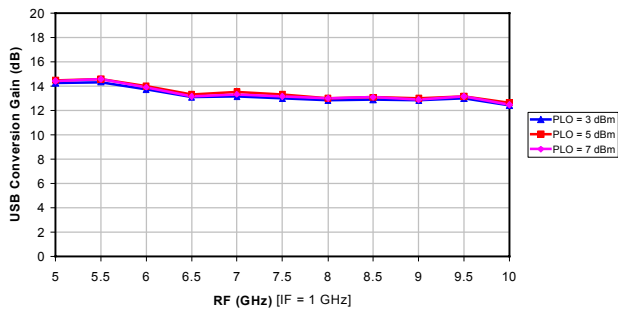

XR1011-QH: LSB IIP3 (dBm) vs. RF (GHz).
4 V @ 130 mA

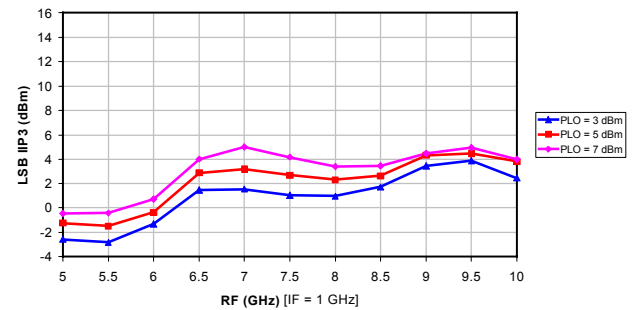

Typical Performance Curves

XR1011-QH: USB IIP3 (dBm) vs. RF (GHz).
4 V @ 130 mA

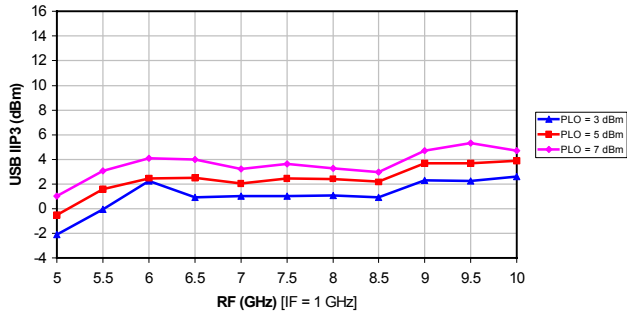

XR1011-QH: LO/RF Isolation (dB) vs. RF (GHz).
4V @ 130mA, PLO = 5dBm

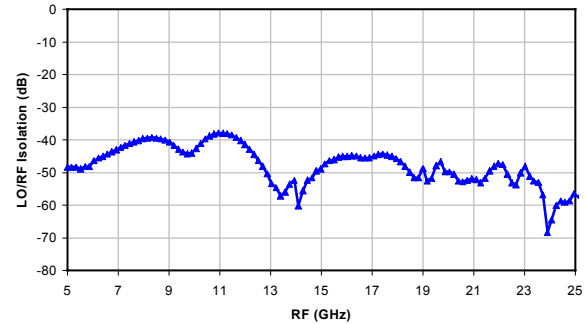

MTTF

MTTF is calculated from accelerated life-time data of single devices and assumes an isothermal back-plate.

XR1011-QH: MTTF (hours) vs. Backplate Temp (°C)

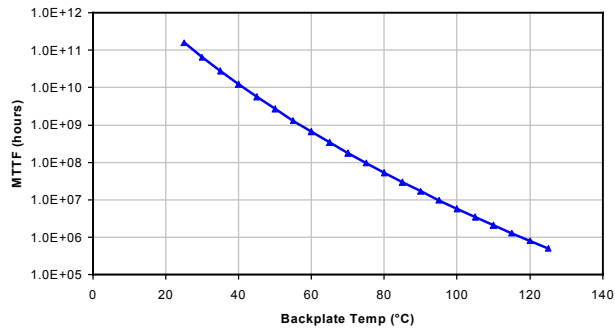

MxN Spurious Outputs

		nLO				
		0	1	2	3	4
mRF	0	-	33	38	49	61
	1	30	0	71	74	-
	2	66	65	17	80	72
	3	97	105	79	30	79
	4	>110	>110	108	88	45

RF=7.5GHz @-10dBm
LO=6.5GHz @+5dBm
Data measured without 90deg hybrid
All values in dBc below IF power level

LO Harmonics

LO Freq (GHz)	nLO Spur, RF Port			
	1	2	3	4
4	53	70	70	88
5	57	71	79	64
6	54	66	67	64
7	50	102	61	81
8	49	74	61	67
9	51	54	71	70
10	50	45	72	80
11	48	40	62	64
12	53	42	64	48

LO = +5 dBm

Values in dBc relative to LO input level, measured at RF IN port

App Note [1] Biasing -

As shown in the Pin Designations table, the device is operated by biasing VD1,2,3 at 4 V with 25, 45, 60 mA respectively. Additionally, a fixed voltage bias of -2 V is required for mixer bias. It is recommended to use active bias to keep the currents constant in order to maintain the best performance over temperature. Depending on the supply voltage available and the power dissipation constraints, the bias circuit may be a single transistor or a low power operational amplifier, with a low value resistor in series with the drain supply used to sense the current. The gate is controlled to maintain correct drain current and thus drain voltage. The typical gate voltage needed to do this is -0.3 V. Make sure to sequence the applied voltage to ensure negative gate bias is available before applying the positive drain supply.

App Note [2] Board Layout -

As shown in the board layout, it is recommended to provide 100 pF decoupling caps as close to the bias pins as possible, with additional 10 μ F decoupling caps.

Recommended Board Layout

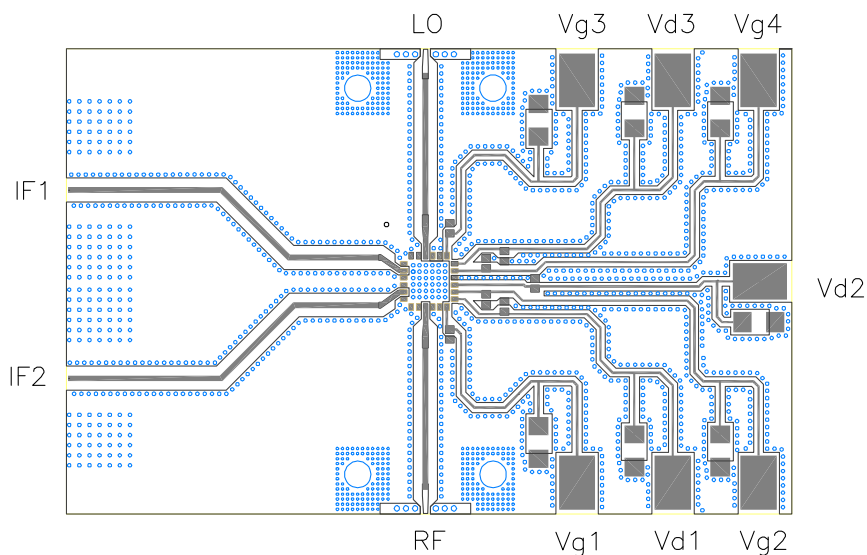

Recommended Decoupling Capacitors: 100pF0402,
10 μ F0805
Recommend to externally ground all N/C pins

Receiver
4.5 - 10.5 GHz

Rev. V2

Lead-Free 4 mm 24-Lead PQFN[†]

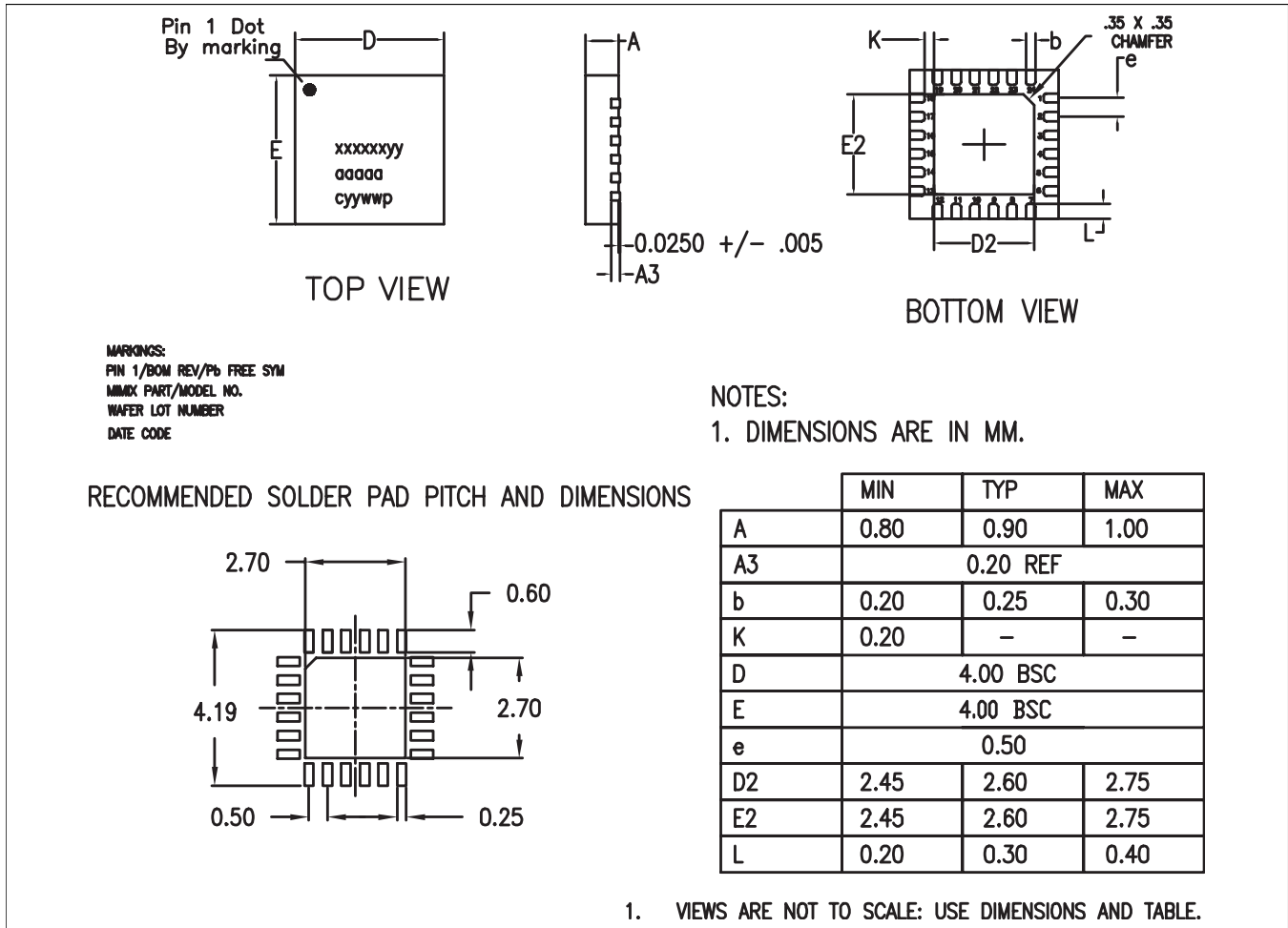

[†] Reference Application Note S2083 for lead-free solder reflow recommendations.
Plating is 100% matte tin over copper.

MACOM Technology Solutions Inc. All rights reserved.

Information in this document is provided in connection with MACOM Technology Solutions Inc ("MACOM") products. These materials are provided by MACOM as a service to its customers and may be used for informational purposes only. Except as provided in MACOM's Terms and Conditions of Sale for such products or in any separate agreement related to this document, MACOM assumes no liability whatsoever. MACOM assumes no responsibility for errors or omissions in these materials. MACOM may make changes to specifications and product descriptions at any time, without notice. MACOM makes no commitment to update the information and shall have no responsibility whatsoever for conflicts or incompatibilities arising from future changes to its specifications and product descriptions. No license, express or implied, by estoppel or otherwise, to any intellectual property rights is granted by this document.

THESE MATERIALS ARE PROVIDED "AS IS" WITHOUT WARRANTY OF ANY KIND, EITHER EXPRESS OR IMPLIED, RELATING TO SALE AND/OR USE OF MACOM PRODUCTS INCLUDING LIABILITY OR WARRANTIES RELATING TO FITNESS FOR A PARTICULAR PURPOSE, CONSEQUENTIAL OR INCIDENTAL DAMAGES, MERCHANTABILITY, OR INFRINGEMENT OF ANY PATENT, COPYRIGHT OR OTHER INTELLECTUAL PROPERTY RIGHT. MACOM FURTHER DOES NOT WARRANT THE ACCURACY OR COMPLETENESS OF THE INFORMATION, TEXT, GRAPHICS OR OTHER ITEMS CONTAINED WITHIN THESE MATERIALS. MACOM SHALL NOT BE LIABLE FOR ANY SPECIAL, INDIRECT, INCIDENTAL, OR CONSEQUENTIAL DAMAGES, INCLUDING WITHOUT LIMITATION, LOST REVENUES OR LOST PROFITS, WHICH MAY RESULT FROM THE USE OF THESE MATERIALS.

MACOM products are not intended for use in medical, lifesaving or life sustaining applications. MACOM customers using or selling MACOM products for use in such applications do so at their own risk and agree to fully indemnify MACOM for any damages resulting from such improper use or sale.