

4.0-11.0 GHz GaAs MMIC Buffer Amplifier, QFN

March 2010 - Rev 13-Mar-10

Features

- X Excellent Transmit LO/Output Buffer Stage
- X 3x3mm, QFN
- X 23.0 dB Small Signal Gain
- X +19.0 dBm P1dB Compression Point
- X 4.5 dB Noise Figure
- X Variable Gain with Adjustable Bias
- X 100% RF, DC and Output Power Testing



General Description

Mimix Broadband's two stage 4.0-11.0 GHz GaAs MMIC buffer amplifier has a small signal gain of 23.0 dB with a +20.0 dBm P1dB output compression point. The device also provides variable gain regulation with adjustable bias. The device is ideally suited as an LO or RF buffer stage with broadband performance at a very low cost. The device comes in an RoHS compliant 3x3mm QFN surface mount package offering excellent RF and thermal properties. This device is well suited for Microwave and Millimeter-wave Point-to-Point Radio, LMDS, SATCOM and VSAT applications.

Absolute Maximum Ratings

Supply Voltage (Vd)	+4.3 VDC
Supply Current (Id1)	200 mA
Gate Bias Voltage (Vg)	0V
Input Power (Pin)	+20.0 dBm
Storage Temperature (Tstg)	-65 to +165 °C
Operating Temperature (Ta)	-55 to +85 °C
Channel Temperature (Tch)	150 °C
ESD Min. - Machine Model (MM)	Class A
ESD Min. - Human Body Model (HBM)	Class 1A
MSL Level	MSL1

Channel temperature affects a device's MTTF. It is recommended to keep channel temperature as low as possible for maximum life.

Electrical Characteristics (Ambient Temperature T = 25 °C)

Parameter	Units	Min.	Typ.	Max.
Frequency Range (f)	GHz	4.0	-	11.0
Input Return Loss (S11)	dB	-	20.0	-
Output Return Loss (S22)	dB	-	12.0	-
Small Signal Gain (S21)	dB	-	23.0	-
Gain Flatness (ΔS_{21})	dB	-	+/-1.5	-
Reverse Isolation (S12)	dB	-	50.0	-
Noise Figure	dB	-	4.5	-
Output Power for 1dB Compression (P1dB)	dBm	-	+19.0	-
Saturated Output Power (Psat)	dBm	-	+21.0	-
Output IP3 (OIP3)	dBm	-	31	-
Drain Bias Voltage (Vd)	VDC	-	+4.0	+4.0
Gate Bias Voltage (Vg)	VDC	-1.0	-0.35	-0.1
Supply Current (Id) (Vd=4.0V, Vg2=-0.5V Typical)	mA	-	100	130

4.0-11.0 GHz GaAs MMIC Buffer Amplifier, QFN

March 2010 - Rev 13-Mar-10

Buffer Amplifier Measurements

XB1007-QT: S11 vs Frequency
Vd=4V, Id=100mA

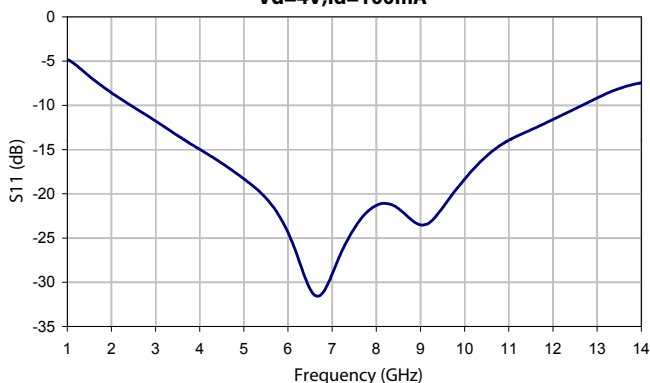

XB1007-QT: S21 vs Frequency
Vd=4V, Id=100mA

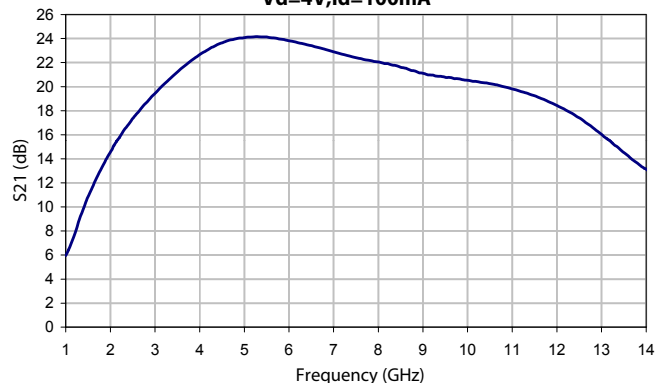

XB1007-QT: S12 vs Frequency
Vd=4V, Id=100mA

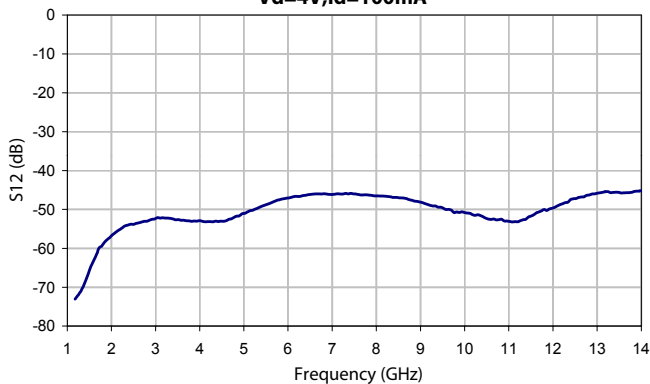

XB1007-QT: S22 vs Frequency
Vd=4V, Id=100mA

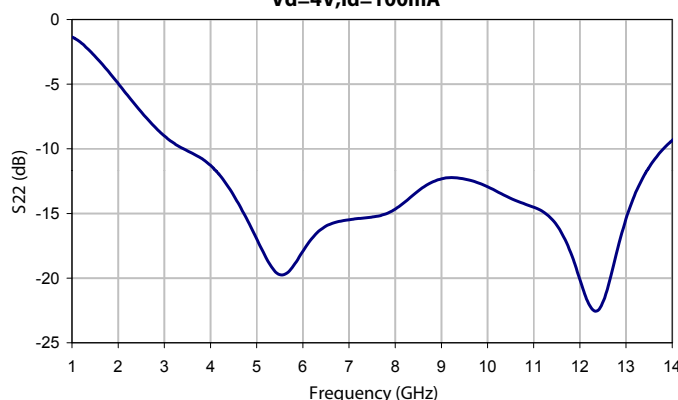

XB1007-QT: P1dB vs Frequency
Vd=4V, Id=130mA

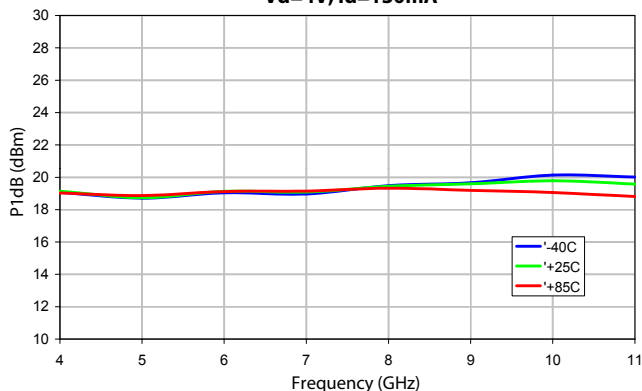

XB1007-QT: Psat vs Frequency
Vd=4V, Id=130mA

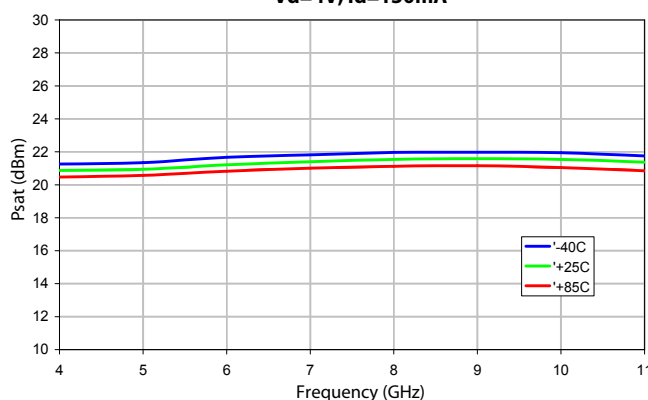

4.0-11.0 GHz GaAs MMIC Buffer Amplifier, QFN



March 2010 - Rev 13-Mar-10

B1007-QT
RoHS

Buffer Amplifier Measurements (cont.)

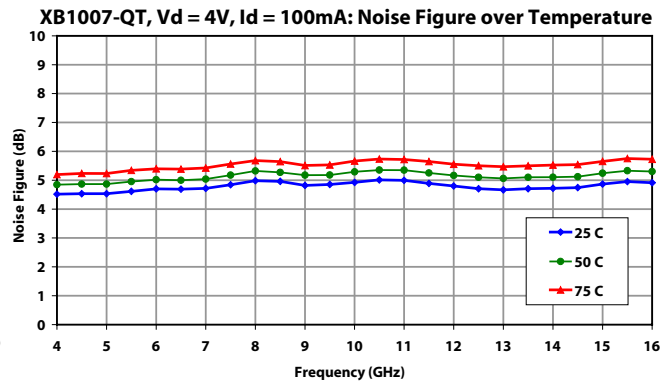
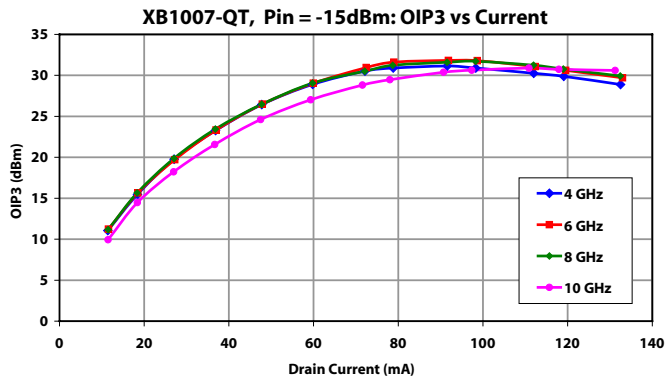
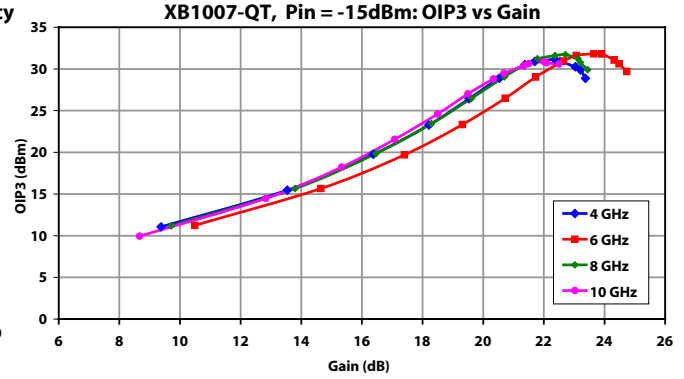
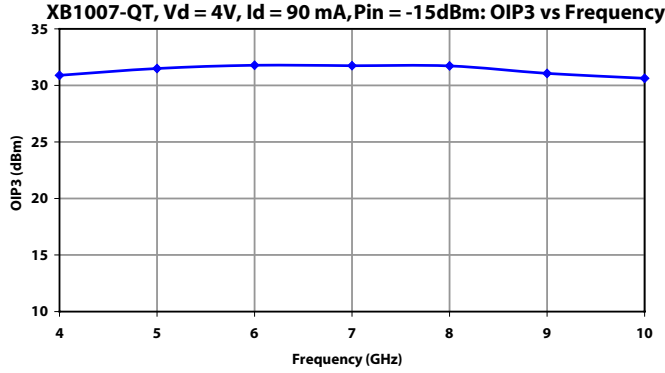

4.0-11.0 GHz GaAs MMIC Buffer Amplifier, QFN

March 2010 - Rev 13-Mar-10

Package Dimensions / Layout

QT (3x3 mm)

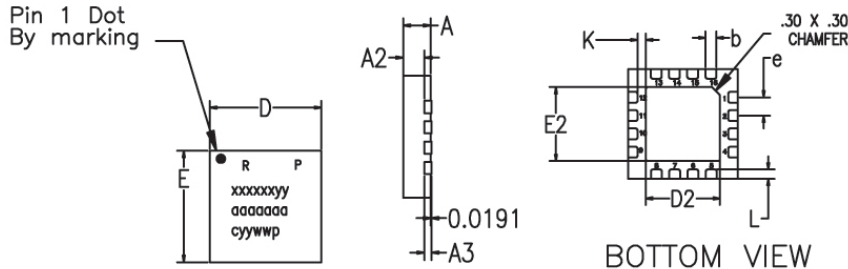

MARKINGS:
PIN 1/BOM REV/PLATING
MIMIX PART/MODEL NO.
WAFER LOT NUMBER
DATE CODE

TOP VIEW

RECOMMENDED SOLDER PAD PITCH AND DIMENSIONS

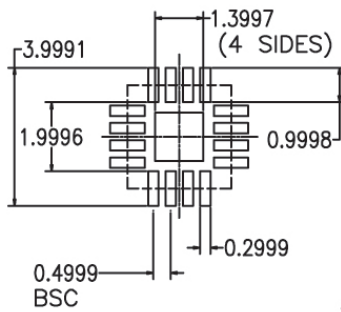

	MIN	TYP	MAX
A	0.80	0.90	1.00
A3	0.20 REF		
A2	0.00	0.65	1.00
b	0.20	0.25	0.30
K	0.20	-	-
D	3.00 BSC		
E	300 BSC		
e	0.50		
D2	1.50	1.65	1.80
E2	1.50	1.65	1.80
L	0.16	0.26	0.36

1. VIEWS ARE NOT TO SCALE: USE DIMENSIONS AND TABLE.

(Note: Engineering designator is 8MPA0811)

Functional Block Diagram

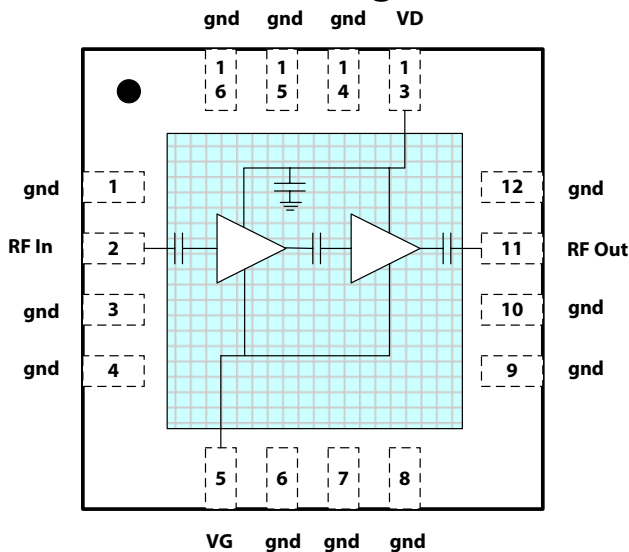

Pin Designations

Pin Number	Pin Name	Pin Function	Nominal Value
1	GND	Ground	
2	RF In	RF Input	
3-4	GND	Ground	
5	VG	Gate Bias	-0.5V
6-10	GND	Ground	
11	RF Out	RF Output	
12	GND	Ground	
13	VD	Drain Bias	4.0V, 100 mA
14-16	GND	Ground	

4.0-11.0 GHz GaAs MMIC Buffer Amplifier, QFN

March 2010 - Rev 13-Mar-10

App Note [1] Biasing - The device provides variable gain with adjustable bias regulation. For optimum linearity performance, it is recommended to bias this device at $V_d=4V$ with $I_d=100\text{ mA}$. It is also recommended to use active biasing to control the drain currents because this gives the most reproducible results over temperature or RF level variations. Depending on the supply voltage available and the power dissipation constraints, the bias circuit may be a single transistor or a low power operational amplifier, with a low value resistor in series with the drain supply used to sense the current. The gate of the pHEMT is controlled to maintain correct drain current and thus drain voltage. The typical gate voltage needed to do this is $-0.5V$. Typically the gate is protected with Silicon diodes to limit the applied voltage. Also, make sure to sequence the applied voltage to ensure negative gate bias is available before applying the positive drain supply.

MTTF Graphs

These numbers were calculated based on accelerated life test information and thermal model analysis received from the fabricating foundry.

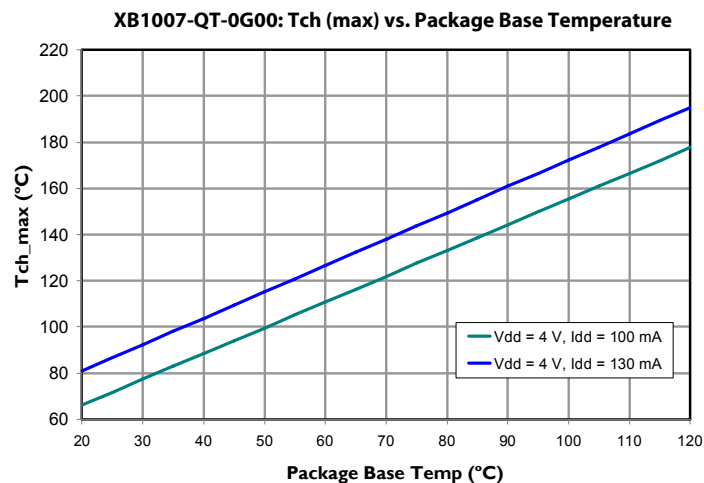
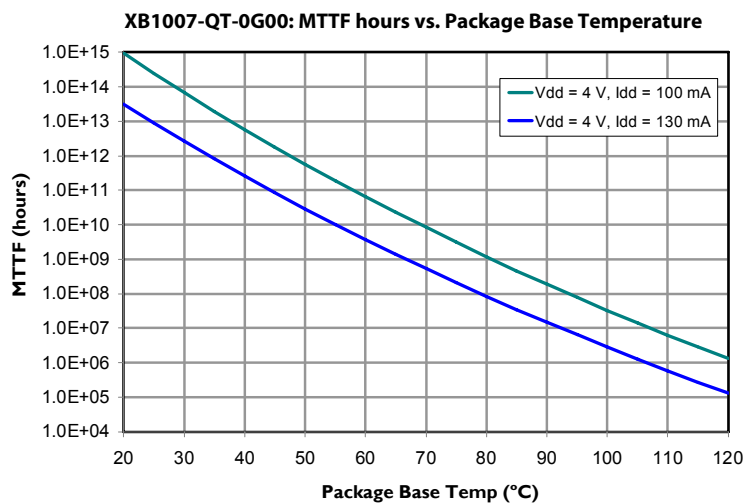

4.0-11.0 GHz GaAs MMIC Buffer Amplifier, QFN

March 2010 - Rev 13-Mar-10

Handling and Assembly Information

CAUTION! - Mimix Broadband MMIC Products contain gallium arsenide (GaAs) which can be hazardous to the human body and the environment. For safety, observe the following procedures:

- Do not ingest.
- Do not alter the form of this product into a gas, powder, or liquid through burning, crushing, or chemical processing as these by-products are dangerous to the human body if inhaled, ingested, or swallowed.
- Observe government laws and company regulations when discarding this product. This product must be discarded in accordance with methods specified by applicable hazardous waste procedures.

Life Support Policy - Mimix Broadband's products are not authorized for use as critical components in life support devices or systems without the express written approval of the President and General Counsel of Mimix Broadband. As used herein: (1) Life support devices or systems are devices or systems which, (a) are intended for surgical implant into the body, or (b) support or sustain life, and whose failure to perform when properly used in accordance with instructions for use provided in the labeling, can be reasonably expected to result in a significant injury to the user. (2) A critical component is any component of a life support device or system whose failure to perform can be reasonably expected to cause the failure of the life support device or system, or to affect its safety or effectiveness.

Package Attachment - This packaged product from Mimix Broadband is provided as a rugged surface mount package compatible with high volume solder installation. Vacuum tools or other suitable pick and place equipment may be used to pick and place this part. Care should be taken to ensure that there are no voids or gaps in the solder connection so that good RF, DC and ground connections are maintained. Voids or gaps can eventually lead not only to RF performance degradation, but reduced reliability and life of the product due to thermal stress.

Typical Reflow Profiles

Reflow Profile	SnPb	Pb Free
Ramp Up Rate	3-4 °C/sec	3-4 °C/sec
Activation Time and Temperature	60-120 sec @ 140-160 °C	60-180 sec @ 170-200 °C
Time Above Melting Point	60-150 sec	60-150 sec
Max Peak Temperature	240 °C	265 °C
Time Within 5 °C of Peak	10-20 sec	10-20 sec
Ramp Down Rate	4-6 °C/sec	4-6 °C/sec

Factory Automation and Identification

Mimix Designator	Package Type	Number of leads offered	W Tape Width	P ₁ Component Pitch	P ₀ Hole Pitch	Reel Diameter	Units per Reel
-QT	QFN (3x3mm)	16	12mm	8mm	4mm	329mm (13in)	2000

Component Orientation: Parts are to be oriented with the PIN 1 closest to the tape's round sprocket holes on the tape's trailing edge.

Note: Tape and Reel packaging is ordered with a -000T suffix. Package is available in 500 unit reels through designated sales channels. Minimum order quantities should be discussed with your local sales representative.

Mimix Lead-Free RoHS Compliant Program - Mimix has an active program in place to meet customer and governmental requirements for eliminating lead (Pb) and other environmentally hazardous materials from our products. All Mimix RoHS compliant components are form, fit and functional replacements for their non-RoHS equivalents. Lead plating of our RoHS compliant parts is 100% matte tin (Sn) over copper alloy and is backwards compatible with current standard SnPb low-temperature reflow processes as well as higher temperature (260°C reflow) "Pb Free" processes.

Ordering Information

Part Number for Ordering

XB1007-QT-0G00
XB1007-QT-0G0T
XB1007-QT-EV1

Description

Matte Tin plated RoHS compliant 3x3 16L QFN surface mount package in bulk quantity
Matte Tin plated RoHS compliant 3x3 16L QFN surface mount package in tape and reel
XB1007-QT evaluation board



Proper ESD procedures should be followed when handling this device.