

## RF Power MOSFET Transistor 20W, 100-500 MHz, 28V

Rev. V1

### Features

- N-channel enhancement mode device
- DMOS structure
- Lower capacitances for broadband operation
- High saturated output power
- Lower noise figure than competitive devices

### ABSOLUTE MAXIMUM RATINGS AT 25° C

| Parameter            | Symbol        | Rating     | Units |
|----------------------|---------------|------------|-------|
| Drain-Source Voltage | $V_{DS}$      | 65         | V     |
| Gate-Source Voltage  | $V_{GS}$      | 20         | V     |
| Drain-Source Current | $I_{DS}$      | 4          | A     |
| Power Dissipation    | $P_D$         | 61         | W     |
| Junction Temperature | $T_J$         | 200        | °C    |
| Storage Temperature  | $T_{STG}$     | -55 to 150 | °C    |
| Thermal Resistance   | $\theta_{JC}$ | 2.86       | °C/W  |

### TYPICAL DEVICE IMPEDANCES

| F (MHz)   | $Z_{IN}$ ( $\Omega$ ) | $Z_{LOAD}$ ( $\Omega$ ) |
|---|-----------------------|-------------------------|
| 100   | 8.0-j16.0             | 12.0+j6.0               |
| 300   | 5.5-j8.0              | 9.3+j6.0                |
| 500   | 4.0-j3.8              | 4.5+j4.5                |
| $V_{DD}=28V, I_{DQ}=100\text{ mA}, P_{OUT}=20.0\text{ W}$ |                       |                         |

$Z_{IN}$  is the series equivalent input impedance of the device from gate to source.

$Z_{LOAD}$  is the optimum series equivalent load impedance as measured from drain to ground.

### ELECTRICAL CHARACTERISTICS AT 25°C

| Parameter                      | Symbol       | Min  | Max  | Units         | Test Conditions   |
|--------------------------------|--------------|------|------|---------------|---|
| Drain-Source Breakdown Voltage | $BV_{DSS}$   | 65   | -    | V             | $V_{GS} = 0.0\text{ V}, I_{DS} = 5.0\text{ mA}$   |
| Drain-Source Leakage Current   | $I_{DSS}$    | -    | 1.0  | mA            | $V_{DS} = 28.0\text{ V}, V_{GS} = 0.0\text{ V}$   |
| Gate-Source Leakage Current    | $I_{GSS}$    | -    | 1.0  | $\mu\text{A}$ | $V_{GS} = 20.0\text{ V}, V_{DS} = 0.0\text{ V}$   |
| Gate Threshold Voltage         | $V_{GS(TH)}$ | 2.0  | 6.0  | V             | $V_{DS} = 10.0\text{ V}, I_{DS} = 100.0\text{ mA}$  |
| Forward Transconductance       | $G_M$        | .500 | -    | S             | $V_{DS} = 10.0\text{ V}, I_{DS} = 1000.0\text{ mA}, \Delta V_{GS} = 1.0\text{V}, 80\ \mu\text{s Pulse}$ |
| Input Capacitance              | $C_{ISS}$    | -    | 45   | pF            | $V_{DS} = 28.0\text{ V}, F = 1.0\text{ MHz}$  |
| Output Capacitance             | $C_{OSS}$    | -    | 30   | pF            | $V_{DS} = 28.0\text{ V}, F = 1.0\text{ MHz}$  |
| Reverse Capacitance            | $C_{RSS}$    | -    | 8    | pF            | $V_{DS} = 28.0\text{ V}, F = 1.0\text{ MHz}$  |
| Power Gain                     | $G_P$        | 10   | -    | dB            | $V_{DD} = 28.0\text{ V}, I_{DQ} = 100.0\text{ mA}, P_{OUT} = 20.0\text{ W } F = 500\text{ MHz}$         |
| Drain Efficiency               | $\eta_D$     | 50   | -    | %             | $V_{DD} = 28.0\text{ V}, I_{DQ} = 100.0\text{ mA}, P_{OUT} = 20.0\text{ W } F = 500\text{ MHz}$         |
| Load Mismatch Tolerance        | VSWR-T       | -    | 20:1 | -             | $V_{DD} = 28.0\text{ V}, I_{DQ} = 100.0\text{ mA}, P_{OUT} = 20.0\text{ W } F = 500\text{ MHz}$         |

### Package Outline

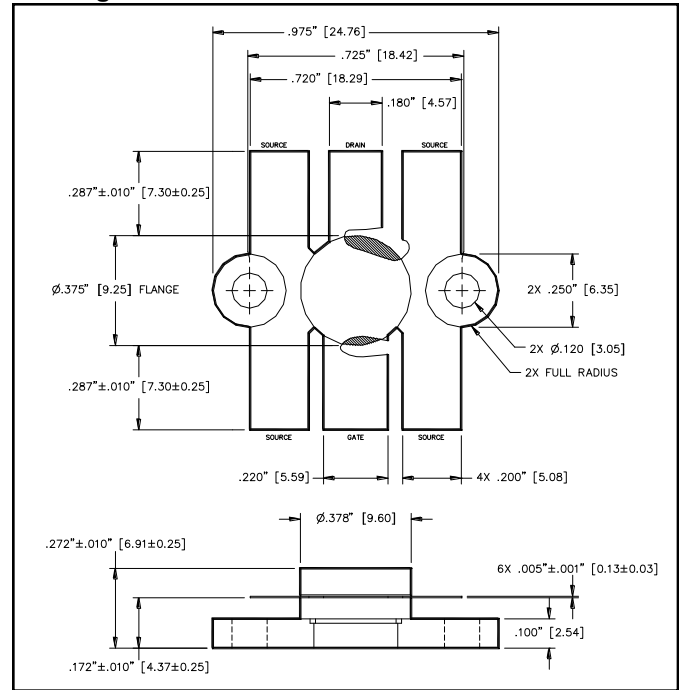

UNLESS OTHERWISE NOTED, TOLERANCES ARE INCHES  $\pm .005$ " [MILLIMETERS  $\pm 0.13\text{mm}$ ]

**Typical Broadband Performance Curves**

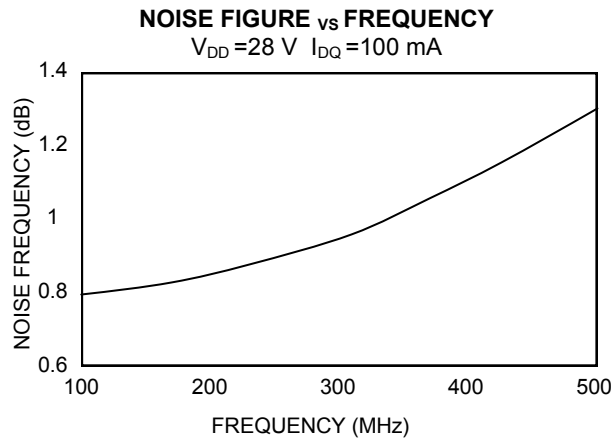
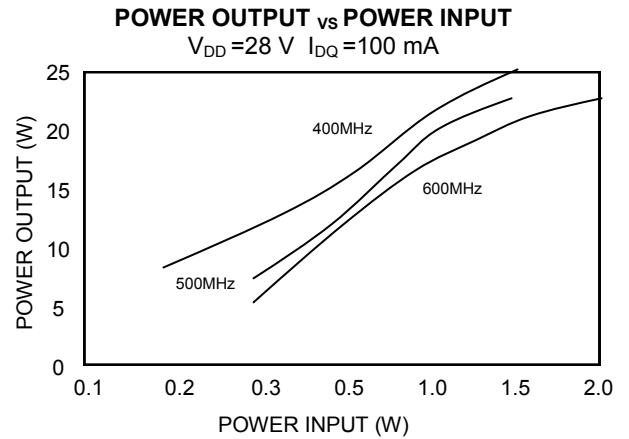
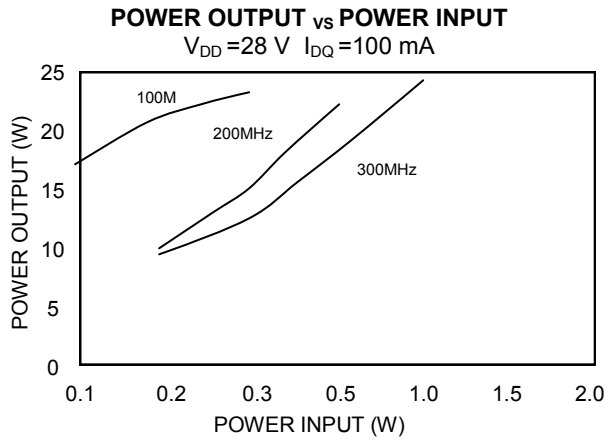
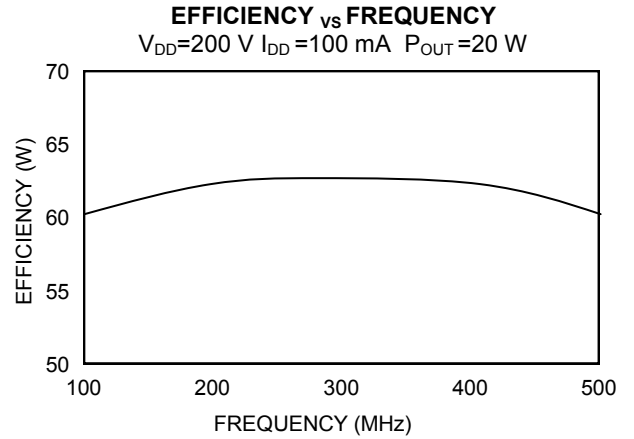
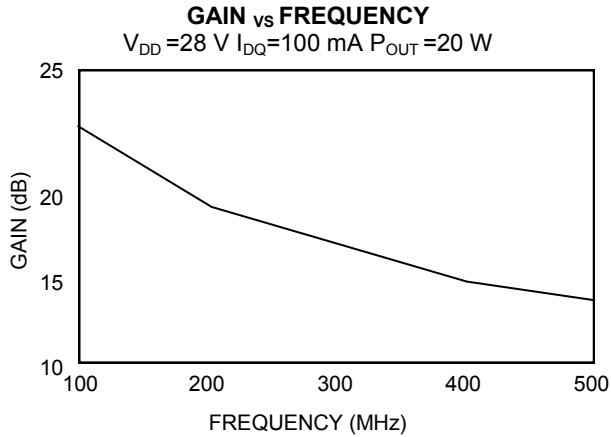

## RF Power MOSFET Transistor 20W, 100-500 MHz, 28V

Rev. V1

### TEST FIXTURE SCHEMATIC

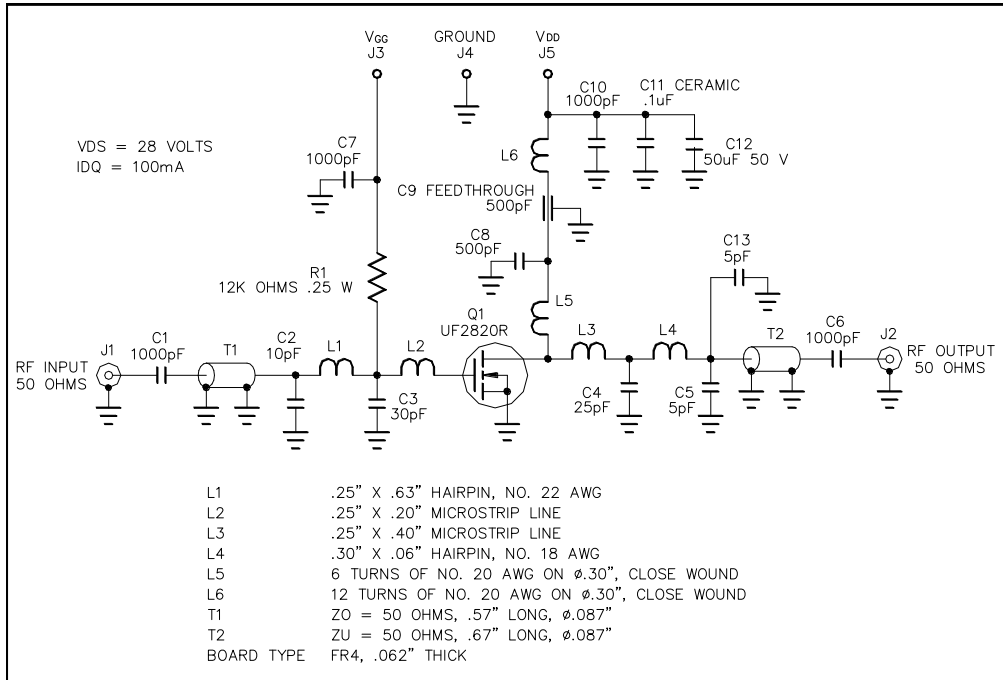

### TEST FIXTURE ASSEMBLY

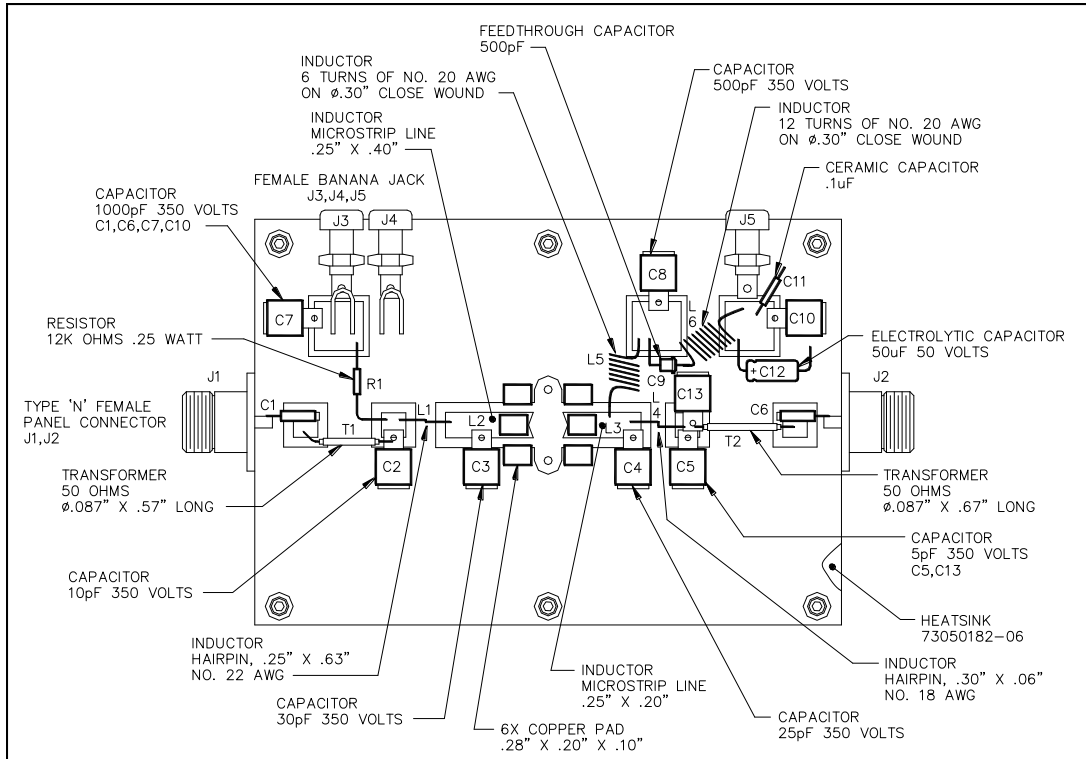

M/A-COM Technology Solutions Inc. All rights reserved.

Information in this document is provided in connection with M/A-COM Technology Solutions Inc ("MACOM") products. These materials are provided by MACOM as a service to its customers and may be used for informational purposes only. Except as provided in MACOM's Terms and Conditions of Sale for such products or in any separate agreement related to this document, MACOM assumes no liability whatsoever. MACOM assumes no responsibility for errors or omissions in these materials. MACOM may make changes to specifications and product descriptions at any time, without notice. MACOM makes no commitment to update the information and shall have no responsibility whatsoever for conflicts or incompatibilities arising from future changes to its specifications and product descriptions. No license, express or implied, by estoppel or otherwise, to any intellectual property rights is granted by this document.

THESE MATERIALS ARE PROVIDED "AS IS" WITHOUT WARRANTY OF ANY KIND, EITHER EXPRESS OR IMPLIED, RELATING TO SALE AND/OR USE OF MACOM PRODUCTS INCLUDING LIABILITY OR WARRANTIES RELATING TO FITNESS FOR A PARTICULAR PURPOSE, CONSEQUENTIAL OR INCIDENTAL DAMAGES, MERCHANTABILITY, OR INFRINGEMENT OF ANY PATENT, COPYRIGHT OR OTHER INTELLECTUAL PROPERTY RIGHT. MACOM FURTHER DOES NOT WARRANT THE ACCURACY OR COMPLETENESS OF THE INFORMATION, TEXT, GRAPHICS OR OTHER ITEMS CONTAINED WITHIN THESE MATERIALS. MACOM SHALL NOT BE LIABLE FOR ANY SPECIAL, INDIRECT, INCIDENTAL, OR CONSEQUENTIAL DAMAGES, INCLUDING WITHOUT LIMITATION, LOST REVENUES OR LOST PROFITS, WHICH MAY RESULT FROM THE USE OF THESE MATERIALS.

MACOM products are not intended for use in medical, lifesaving or life sustaining applications. MACOM customers using or selling MACOM products for use in such applications do so at their own risk and agree to fully indemnify MACOM for any damages resulting from such improper use or sale.