

Gallium Nitride 28V, 45W RF Power Transistor

Built using the SIGANTIC[®] NRF1 process - A proprietary GaN-on-Silicon technology

FEATURES

- Optimized for pulsed, WiMAX, W-CDMA, LTE, and other light thermal load applications from DC to 4.0GHz
- 2500MHz performance
 - 45W P_{3dB} CW power
 - 13.5 dB small signal gain
 - 55% efficiency at P_{3dB}
- 100% RF tested
- Low cost, surface mount SOIC package
- High reliability gold metallization process
- Lead-free and RoHS compliant
- Subject to EAR99 Export Control



**DC - 4000MHz
45 Watt, 28 Volt
GaN HEMT**



RF Specifications (2-Tone): V_{DS} = 28V, I_{DQ} = 400mA, Frequency = 2500MHz, Tone Spacing = 1MHz, T_C = 25°C, Measured in Nitronex Test Fixture

Symbol	Parameter	Min	Typ	Max	Units
P _{3dB}	Average Output Power at 3dB Compression	35	45	-	W
P _{1dB}	Average Output Power at 1dB Compression	-	28	-	W
G _{SS}	Small Signal Gain	12.5	13.5	-	dB
η	Drain Efficiency at 3dB Gain Compression	50	55	-	%

Typical OFDM Performance (2500-2700MHz): V_{DS} = 28V, I_{DQ} = 350mA, P_{OUT,AVG} = 37dBm, single carrier OFDM waveform 64-QAM 3/4, 8 burst, continuous frame data, 10 MHz channel bandwidth. Peak/Avg = 10.3dB @ 0.01% probability on CCDF. T_C = 25°C. Measured in Load Pull System (Refer to Table 2 and Figure 1)

Symbol	Parameter	Typ	Units
EVM	Error Vector Magnitude	2.0	%
G _P	Power Gain	13.0	dB
η	Drain Efficiency	27	%

Typical OFDM Performance (3300-3500MHz): V_{DS} = 28V, I_{DQ} = 350mA, P_{OUT,AVG} = 36.5dBm, single carrier OFDM waveform 64-QAM 3/4, 8 burst, 20ms frame, 15ms frame data, 3.5 MHz channel bandwidth. Peak/Avg = 10.3dB @ 0.01% probability on CCDF. T_C = 25°C. Measured in Load Pull System (Refer to Table 2 and Figure 1)

Symbol	Parameter	Typ	Units
EVM	Error Vector Magnitude	2.0	%
G _P	Power Gain	10.5	dB
η	Drain Efficiency	25	%

DC Specifications: $T_C=25^\circ\text{C}$

Symbol	Parameter	Min	Typ	Max	Units
Off Characteristics					
V_{BDS}	Drain-Source Breakdown Voltage ($V_{GS} = -8\text{V}$, $I_D = 16\text{mA}$)	100	-	-	V
I_{DLK}	Drain-Source Leakage Current ($V_{GS} = -8\text{V}$, $V_{DS} = 60\text{V}$)	-	2	10	mA
On Characteristics					
V_T	Gate Threshold Voltage ($V_{DS} = 28\text{V}$, $I_D = 16\text{mA}$)	-2.3	-1.8	-1.3	V
V_{GSQ}	Gate Quiescent Voltage ($V_{DS} = 28\text{V}$, $I_D = 350\text{mA}$)	-2.0	-1.5	-1.0	V
R_{ON}	On Resistance ($V_{GS} = 2\text{V}$, $I_D = 120\text{mA}$)	-	0.25	0.30	Ω
I_D	Drain Current ($V_{DS} = 7\text{V}$ pulsed, 300ms pulse width, 0.2% duty cycle, $V_{GS} = 2\text{V}$)	7.5	9.5	-	A

Absolute Maximum Ratings: Not simultaneous, $T_C=25^\circ\text{C}$ unless otherwise noted

Symbol	Parameter	Max	Units
V_{DS}	Drain-Source Voltage	100	V
V_{GS}	Gate-Source Voltage	-10 to 3	V
P_T	Total Device Power Dissipation (Derated above 25°C)	40	W
θ_{JC}	Thermal Resistance (Junction-to-Case)	4.3	$^\circ\text{C}/\text{W}$
T_{STG}	Storage Temperature Range	-65 to 150	$^\circ\text{C}$
T_J	Operating Junction Temperature	200	$^\circ\text{C}$
HBM	Human Body Model ESD Rating (per JESD22-A114)	1B (>500V)	
MM	Machine Model ESD Rating (per JESD22-A113)	M1(>50V)	
MSL	Moisture Sensitivity Level (per IPC/JEDEC J-STD-020): Rating of 3 at 260°C Package Peak Temperature		

Load-Pull Data, Reference Plane at Device Leads

$V_{DS}=28V$, $I_{DQ}=350mA$, $T_A=25^\circ C$ unless otherwise noted

Table 1: Optimum Source and Load Impedances for CW Gain, Drain Efficiency, and Output Power Performance

Frequency (MHz)	$Z_S (\Omega)$	$Z_L (\Omega)$	$P_{SAT} (W)$	$G_{SS} (dB)$	Drain Efficiency @ P_{SAT} (%)
900	$2.0 + j2.7$	$6.0 + j3.3$	45	22.5	72
1500	$1.6 - j0.8$	$4.5 + j0.5$	45	18.5	70
2500	$2.0 - j3.2$	$3.5 - j5.0$	45	14.0	65
3500	$3.2 - j6.5$	$2.9 - j8.0$	35	12.0	60

Table 2: Optimum Source and Load Impedances for WiMAX Gain, Drain Efficiency, Output Power, and Linearity Performance

Frequency (MHz)	$Z_S (\Omega)$	$Z_L (\Omega)$	$P_{OUT} (W)$	Gain (dB)	Drain Efficiency (%)
2500 ¹	$2.1 - j7.6$	$3.1 - j3.9$	5	14.0	27
2600 ¹	$2.3 - j7.7$	$3.3 - j4.4$	5	13.0	27
2700 ¹	$2.3 - j9.0$	$3.4 - j4.7$	5	13.0	27
3300 ²	$3.3 - j11.8$	$3.7 - j7.2$	6.3	11.5	30
3500 ²	$3.5 - j13.5$	$3.5 - j10.0$	4.5	10.5	25
3800 ²	$4.5 - j16.2$	$3.7 - j11.2$	3.2	8.0	17

Note 1: Single carrier OFDM waveform 64-QAM 3/4, 8 burst, continuous frame data, 10 MHz channel bandwidth.
Peak/Avg = 10.3dB @ 0.01% probability on CCDF, 2% EVM.

Note 2: Single carrier OFDM waveform 64-QAM 3/4, 8 burst, 20ms frame, 15ms frame data, 3.5 MHz channel bandwidth.
Peak/Avg = 10.3dB @ 0.01% probability on CCDF, 2% EVM.

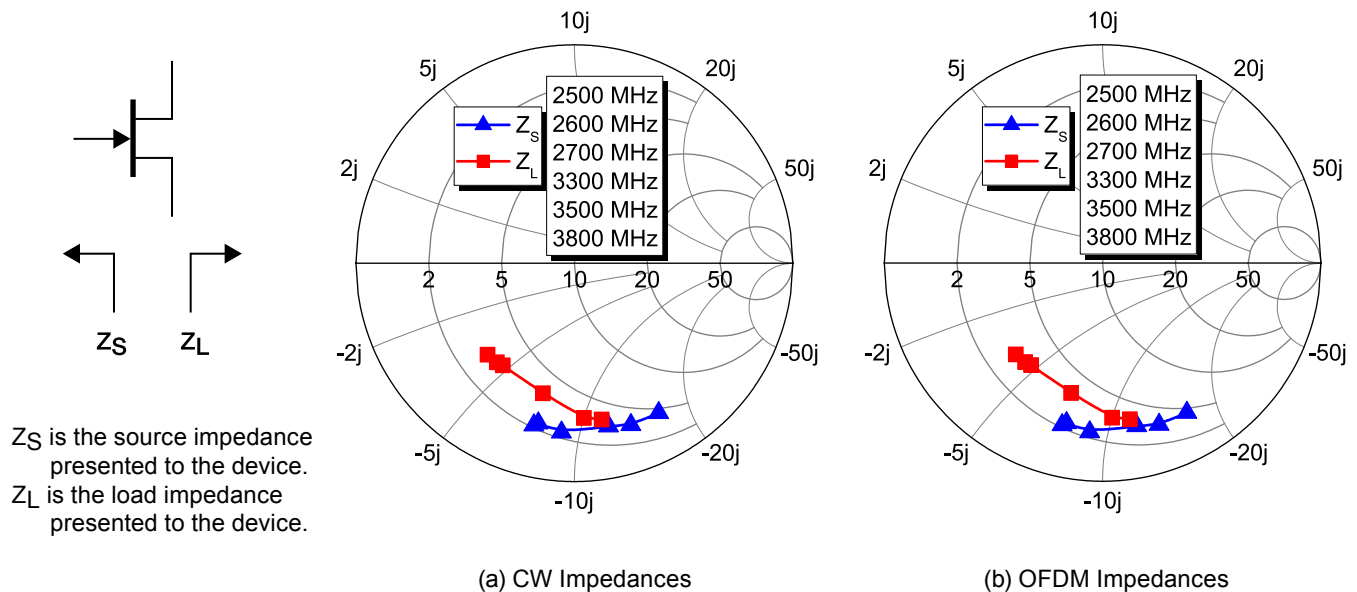

Figure 1 - Optimal Impedances for CW and OFDM Performance

Load-Pull Data, Reference Plane at Device Leads

$V_{DS}=28V$, $I_{DQ}=350mA$, $T_A=25^{\circ}C$ unless otherwise noted.

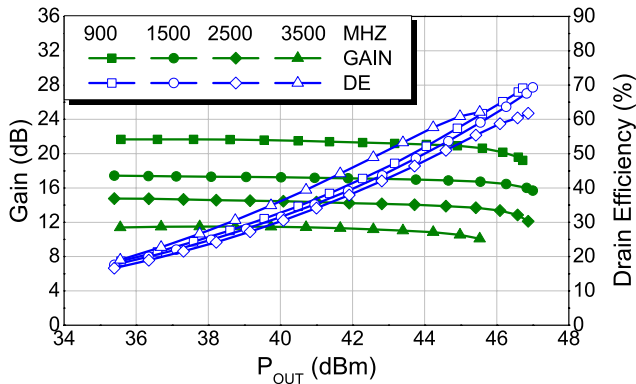

Figure 2 - Typical CW Performance, Frequency = 900 to 3500MHz, $I_{DQ}=400mA$

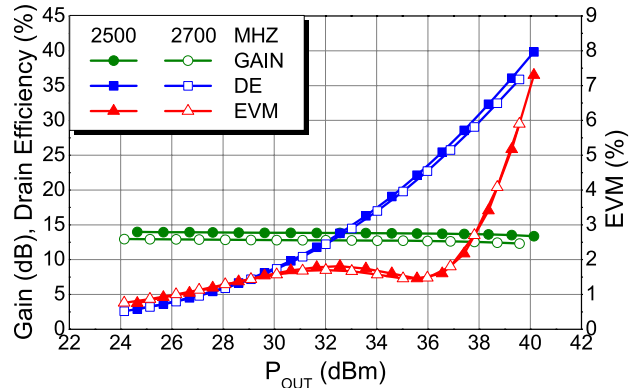

Figure 3 - OFDM Performance Tuned for P_{OUT} at 2% EVM in Load-Pull System

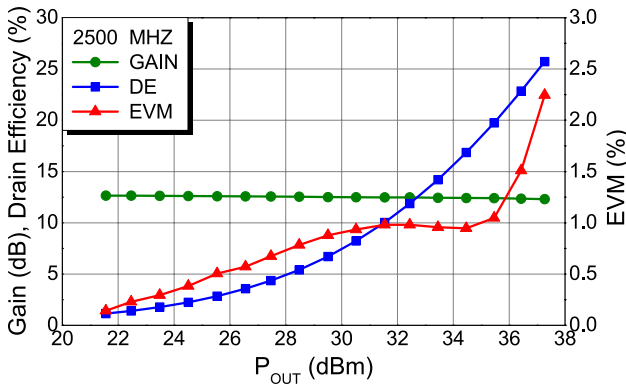

Figure 4 - OFDM Performance Tuned for P_{OUT} at 1.5% EVM in Load-Pull System

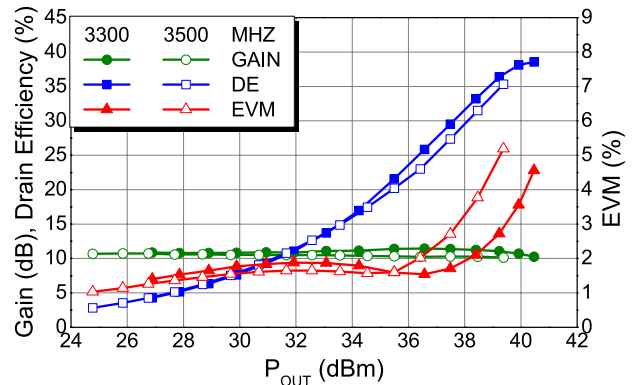

Figure 5 - OFDM Performance Tuned for P_{OUT} at 2% EVM in Load-Pull System

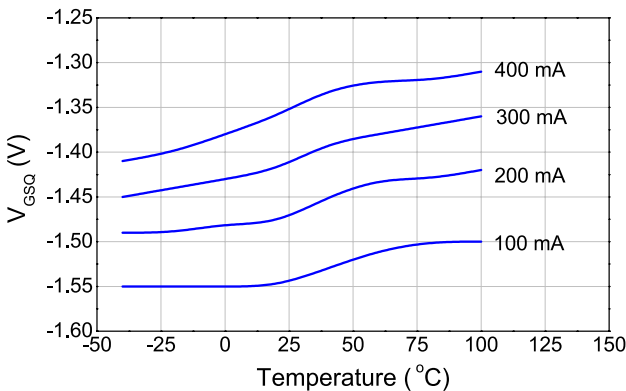

Figure 6 - Quiescent Gate Voltage (V_{GSQ}) Required to Reach I_{DQ} as a Function of Case Temperature

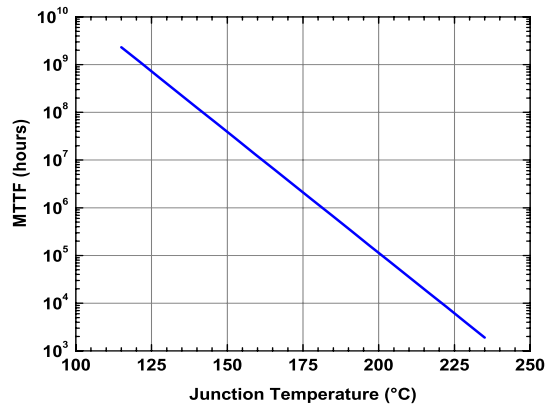

Figure 7 - MTTF of NRF1 devices as a function of junction temperature

NPT1004



Ordering Information

Part Number	Order Multiple	Description
NPT1004DT	97	Tube; NPT1004 in D (PSOP2) Package
NPT1004DR	1500	Tape and Reel; NPT1004 in D (PSOP2) Package

1: To find a Nitronex contact in your area, visit our website at <http://www.nitronex.com>

D Package Dimensions and Pinout

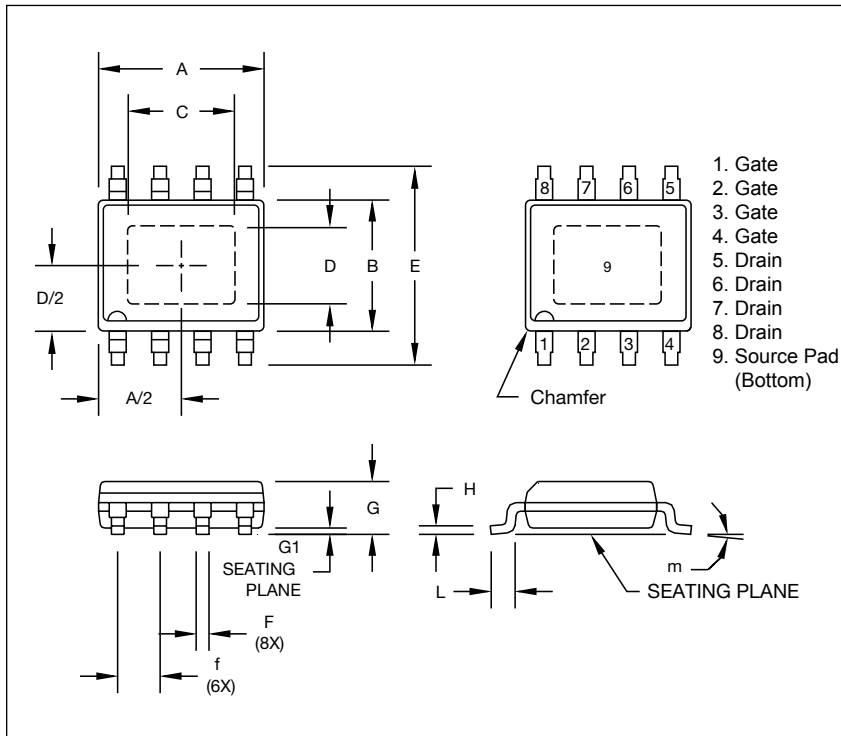

Dim	Inches		Millimeters	
	Min	Max	Min	Max
A	0.189	0.196	4.80	4.98
B	0.150	0.157	3.81	3.99
C	0.107	0.123	2.72	3.12
D	0.071	0.870	1.80	2.21
E	0.230	0.244	5.84	6.22
f	0.50 BSC		1.270 BSC	
F	0.0138	0.0192	0.35	0.49
G	0.055	0.065	1.40	1.65
G1	0.000	0.004	0.00	0.10
H	0.0075	0.0098	0.19	0.25
L	0.016	0.035	0.40	0.89
m	0°	8°	0°	8°

Mounting Footprints

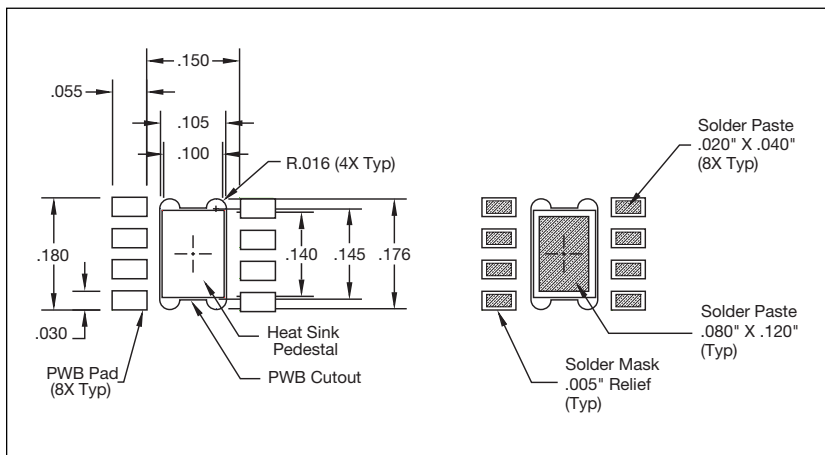

Nitronex, LLC

2305 Presidential Drive
Durham, NC 27703 USA
+1.919.807.9100 (telephone)
+1.919.807.9200 (fax)
info@nitronex.com
www.nitronex.com

Additional Information

**This part is lead-free and is compliant with the RoHS directive
(Restrictions on the Use of Certain Hazardous Substances in Electrical and Electronic Equipment).**

Important Notice

Nitronex, LLC reserves the right to make corrections, modifications, enhancements, improvements and other changes to its products and services at any time and to discontinue any product or service without notice. Customers should obtain the latest relevant information before placing orders and should verify that such information is current and complete. All products are sold subject to Nitronex terms and conditions of sale supplied at the time of order acknowledgment. The latest information from Nitronex can be found either by calling Nitronex at 1-919-807-9100 or visiting our website at www.nitronex.com.

Nitronex warrants performance of its packaged semiconductor or die to the specifications applicable at the time of sale in accordance with Nitronex standard warranty. Testing and other quality control techniques are used to the extent Nitronex deems necessary to support the warranty. Except where mandated by government requirements, testing of all parameters of each product is not necessarily performed.

Nitronex assumes no liability for applications assistance or customer product design. Customers are responsible for their product and applications using Nitronex semiconductor products or services. To minimize the risks associated with customer products and applications, customers should provide adequate design and operating safeguards.

Nitronex does not warrant or represent that any license, either express or implied, is granted under any Nitronex patent right, copyright, mask work right, or other Nitronex intellectual property right relating to any combination, machine or process in which Nitronex products or services are used.

Reproduction of information in Nitronex data sheets is permitted if and only if said reproduction does not alter any of the information and is accompanied by all associated warranties, conditions, limitations and notices. Any alteration of the contained information invalidates all warranties and Nitronex is not responsible or liable for any such statements.

Nitronex products are not intended or authorized for use in life support systems, including but not limited to surgical implants into the body or any other application intended to support or sustain life. Should Buyer purchase or use Nitronex, LLC products for any such unintended or unauthorized application, Buyer shall indemnify and hold Nitronex, LLC, its officers, employees, subsidiaries, affiliates, distributors, and its successors harmless against all claims, costs, damages, and expenses, and reasonable attorney fees arising out of, directly or indirectly, any claim of personal injury or death associated with such unintended or unauthorized use, notwithstanding if such claim alleges that Nitronex was negligent regarding the design or manufacture of said products.

Nitronex and the Nitronex logo are registered trademarks of Nitronex, LLC.
All other product or service names are the property of their respective owners.
©Nitronex, LLC 2012. All rights reserved.