

# High Power High Linearity SP4T Switch DC - 4.2 GHz



MASW-011127

Rev. V1

## Features

- High Power High Linearity SP4T Switch
- Broadband: DC - 4.2 GHz
- No External Matching Components Required
- Insertion Loss:
  - 0.55 dB @ 2.3 GHz
  - 0.7 dB @ 3.5 GHz
- Input P0.1dB: 42 dBm
- Input IP3: 78 dBm
- Dual 5 V & -3.4 V Supplies
- Fast Switching
- Integrated Control Circuitry with 1.8 V Logic
- Lead-Free 4 mm 20 Lead QFN Package
- RoHS\* Compliant

## Applications

- 5G Massive MIMO
- Wireless Infrastructure
- General Wireless

## Description

The MASW-011127 is a compact surface mount, highly integrated, high power SP4T switch in a compact 4 mm QFN package. All the bias circuitry and matching components are internal to the module.

This switch operates from DC - 4.2 GHz and features high power handling, high linearity and low power consumption. The switch requires 5 V and -3.4 V supplies. There are three control pins V1, V2 and SEL and are 1.8 V CMOS compatible.

A select pin allows re-configurability of the control logic for extra flexibility.

## Ordering Information<sup>1</sup>

Part Number	Package
MASW-011127-TR1000	1000 part reel
MASW-011127-001SMB	Sample Board

1. Reference Application Note M513 for reel size information.

## Functional Schematic

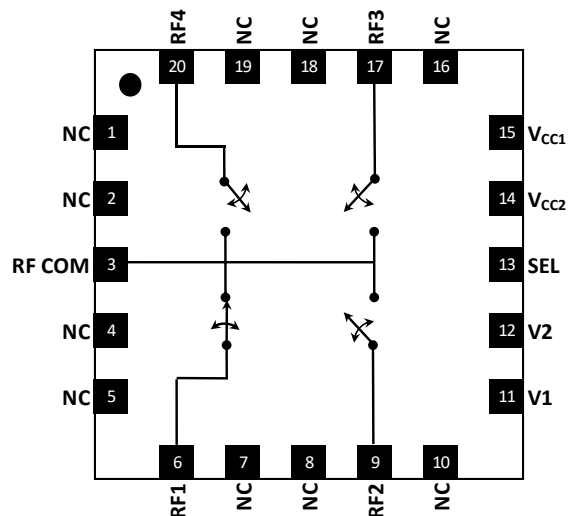

## Pin Names<sup>2</sup>

Pin #	Function
1,2,4,5,7,8,10,16,18,19	NC
3	RF COM
6	RF1
9	RF2
11	V1
12	V2
13	SEL
14	V <sub>CC2</sub>
15	V <sub>CC1</sub>
17	RF3
20	RF4
21	Paddle <sup>3</sup>

2. MACOM recommends connecting unused package pins to ground.

3. The exposed pad centered on the package bottom must be connected to RF, DC and thermal ground.

\* Restrictions on Hazardous Substances, compliant to current RoHS EU directive.

# High Power High Linearity SP4T Switch DC - 4.2 GHz



MASW-011127  
Rev. V1

## Pin Description

Pin #	Name	Description
1, 2, 4, 5, 7, 8, 10, 16, 18, 19	NC	Not internally connected. Recommend to be connected to RF/DC ground
3	RF COM	RF Common Port. The RF COM pin is DC-coupled to 0 V and AC matched to 50 $\Omega$ . No DC blocking capacitor is required when the RF line potential is equal to 0 V DC.
6	RF1	Switch RF Port 1. The RF1 pin is DC-coupled to 0 V and AC matched to 50 $\Omega$ . No DC blocking capacitor is required when the RF line potential is equal to 0 V DC.
9	RF2	Switch RF Port 2. The RF2 pin is DC-coupled to 0 V and AC matched to 50 $\Omega$ . No DC blocking capacitor is required when the RF line potential is equal to 0 V DC.
11	V1	Control Logic Input 1. No internal pull-up/down resistor.
12	V2	Control Logic Input 2. No internal pull-up/down resistor.
13	SEL	Control Logic Input Select. No internal pull-up/down resistor.
14	V <sub>CC2</sub>	Negative Supply, VCC2 = -3.4 V
15	V <sub>CC1</sub>	Positive Supply VCC1 = 5 V
17	RF3	Switch RF Port 3. The RF3 pin is DC-coupled to 0 V and AC matched to 50 $\Omega$ . No DC blocking capacitor is required when the RF line potential is equal to 0 V DC.
20	RF4	Switch RF Port 4. The RF4 pin is DC-coupled to 0 V and AC matched to 50 $\Omega$ . No DC blocking capacitor is required when the RF line potential is equal to 0 V DC.
Paddle	GND	Exposed Pad. The exposed pad must be connected to a large RF/DC ground island providing thermal capabilities for heat dissipation

## Recommended Operating Conditions

Parameter	Conditions	Unit	Min.	Typ.	Max.
RF Port Input Power	RF COM, RF1, RF2, RF3, RF4, 3.5 GHz CW LTE	dBm	—	—	42.5 40.0
Digital Logic Input V1, V2, SEL	V1, V2, SEL	V	-0.3	—	2.25
DC Positive Supply ( $V_{CC1}$ )	—	V	4.75	5.0	5.25
DC Negative Supply ( $V_{CC2}$ )	—	V	-3.55	-3.4	-3.25
Operating Temperature <sup>4</sup>	—	°C	-40	—	+105
Junction Temperature <sup>5,6</sup>	—	°C	—	—	+125
Storage Temperature	—	°C	-65	—	+150

4. Operating/Case Temperature ( $T_C$ ) is measured at the exposed pad.

5. Operating at nominal conditions with  $T_J \leq +125^\circ\text{C}$  will ensure MTF  $> 1 \times 10^6$  hours.

6. Junction Temperature ( $T_J$ ) =  $T_C + \Theta_{JC} * P_{DISS}$   
Typical thermal resistance ( $\Theta_{JC}$ ) = 11.4 °C/W.  
 $P_{DISS}$  is the total dissipated DC and RF power.

## Absolute Maximum Ratings<sup>7,8</sup>

Parameter	Conditions	Unit	Min.	Typ.	Max.
RF Port Input Power	RF COM, RF1, RF2, RF3, RF4, 3.5 GHz CW LTE	dBm	—	—	43.0 40.5
Digital Logic Input V1, V2, SEL	V1, V2, SEL	V	-0.3	—	3.6
DC Positive Supply ( $V_{CC1}$ )	—	V	-0.3	—	6.0
DC Negative Supply ( $V_{CC2}$ )	—	V	-3.6	—	-3.0
Junction Temperature <sup>7,8</sup>	—	°C	—	—	+135
Storage Temperature	—	°C	-65	—	+150

7. Exceeding any one or combination of these limits may cause permanent damage to this device.

8. MACOM does not recommend sustained operation near these survivability limits.

## Handling Procedures

Please observe the following precautions to avoid damage:

## Static Sensitivity

These electronic devices are sensitive to electrostatic discharge (ESD) and can be damaged by static electricity. Proper ESD control techniques should be used when handling these HBM Class 1C, CDM Class C2A devices.

# High Power High Linearity SP4T Switch

## DC - 4.2 GHz



MASW-011127

Rev. V1

**AC Electrical Specifications:  $P_{IN} = -10$  dBm,  $T_A = 25$  °C,  $V_{CC1} = +5$  V,  $V_{CC2} = -3.4$  V,  $Z_0 = 50$  Ω**

Parameter	Test Conditions	Units	Min.	Typ.	Max.
Insertion Loss (All Paths)	150 MHz 1.0 GHz 2.3 GHz 3.5 GHz	dB	—	0.25 0.3 0.55 0.70	— — 0.8 —
Isolation (RF COM-RF1 & RF COM-RF4)	150 MHz 1.0 GHz 2.3 GHz 3.5 GHz	dB	— — 27 —	60 42 32 28	—
Isolation (RF COM-RF2 & RF COM-RF3)	150 MHz 1.0 GHz 2.3 GHz 3.5 GHz	dB	— — 27 —	60 42 32 26	—
Return Loss (All RF ports)	150 MHz 1.0 GHz 2.3 GHz 3.5 GHz	dB	—	45 26 17 16	—
Phase difference (All RF ports)	2.3 GHz	°	—	1.8	—
Two-Tone Input IP3	Two-Tone, $P_{IN}/\text{Tone} = +34$ dBm, 50 MHz Tone Spacing, 3.5 GHz	dBm	—	78	—
Input P0.1dB	150 MHz 2.0 GHz 3.5 GHz	dBm	—	41.8 42.0 41.5	—

**DC Electrical Specifications:  $V_{CC1} = +5$  V,  $V_{CC2} = -3.4$  V**

Parameter	Test Conditions	Units	Min.	Typ.	Max.
Supply Voltage 1	$V_{CC1}$	V	—	5	—
Supply 1 Current	$I_{CC1}$	mA	—	0.5	—
Supply Voltage 2	$V_{CC2}$	V	—	-3.4	—
Supply 2 Current	$I_{CC2}$	mA	—	0.5	—
Control Voltage (pins SEL, V1, V2)	Logic High Logic Low	V	1.2 -0.3	1.8 0	2.25 0.6
Logic Input Current (pins SEL, V1, V2)	Logic High Logic Low	μA	-10	—	10

# High Power High Linearity SP4T Switch DC - 4.2 GHz



MASW-011127  
Rev. V1

## Transient Electrical Specifications: $V_{CC1} = 5\text{ V}$ , $V_{CC2} = -3.4\text{ V}$

Parameter	Test Conditions	Units	Min.	Typ.	Max.
Settling Time	50% $V_{CTRL}$ to gain settled to IL +/- 0.5 dB RF = 3.5 GHz	us	—	0.9	—

## Control Truth Table

For SEL=0			For SEL=1		
Path to COM	V2	V1	Path to COM	V2	V1
RF1	0	0	RF1	1	1
RF2	0	1	RF2	1	0
RF3	1	0	RF3	0	1
RF4	1	1	RF4	0	0

# High Power High Linearity SP4T Switch DC - 4.2 GHz



MASW-011127  
Rev. V1

## PCB Layout

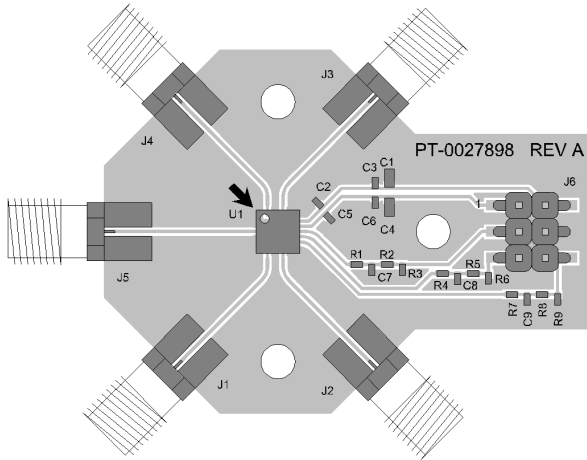

## Parts List

Part	Value	Case Style
C1, C4	10 $\mu$ F	0603
C2, C5	470 pF	0402
C3, C6	10 nF	0402
C7-9	5 pF	0402
R1, R4, R7	0 $\Omega$	0402
R2, R5, R8	1 k $\Omega$	0402
R3, R6, R9	47 k $\Omega$	0402
J1-5	142-0761-841	SMA, End Launch

## Application Schematic

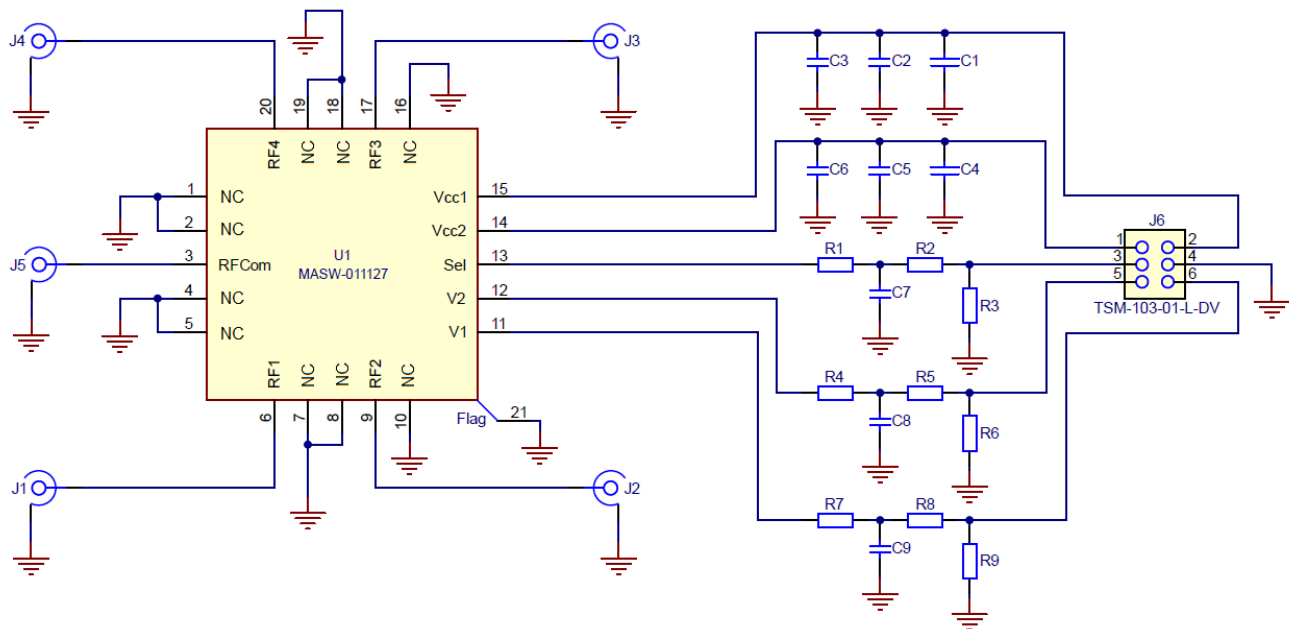

## Power Supplies

De-coupling capacitors should be placed at the  $V_{CC1}$  and  $V_{CC2}$  supply pin to minimize noise and fast transients. Supply voltage change or transients should have a slew rate smaller than 1 V / 10  $\mu$ s. In addition, all control pins should remain at 0 V (+/- 0.3 V) and no RF power should be applied while the supply voltage ramps or while it returns to zero.

$V_{CC1}$  and  $V_{CC2}$  can be sequenced in any order at power up or power down.

# High Power High Linearity SP4T Switch DC - 4.2 GHz



MASW-011127  
Rev. V1

Typical Performance Curves:  $P_{IN} = -10 \text{ dBm}$ ,  $V_{CC1} = 5 \text{ V}$ ,  $V_{CC2} = -3.4 \text{ V}$ ,  $Z_0 = 50 \Omega$

Switch Insertion Loss<sup>9</sup>, RFCOM-RF1

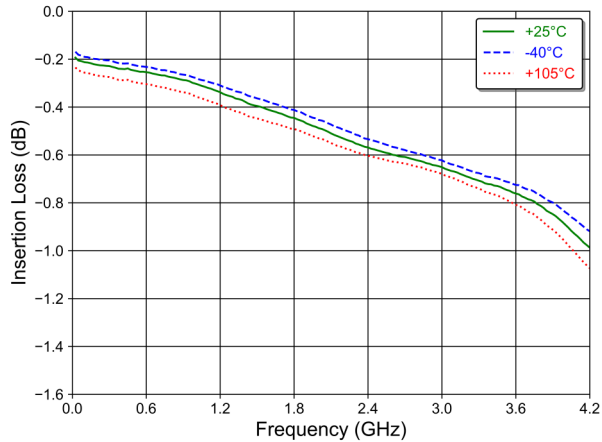

Switch Insertion Loss<sup>9</sup>, RFCOM-RF2

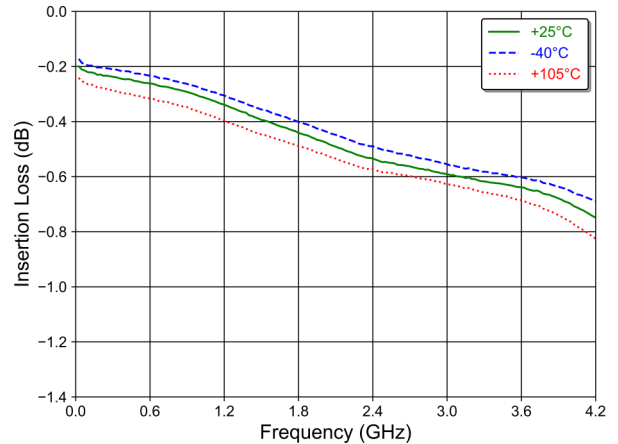

Switch Insertion Loss<sup>9</sup>, RFCOM-RF3

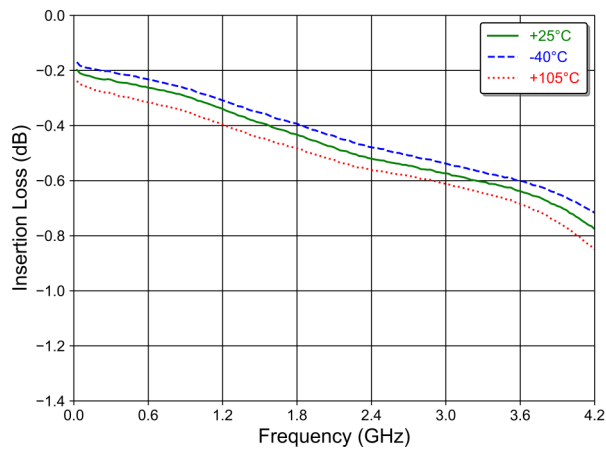

Switch Insertion Loss<sup>9</sup>, RFCOM-RF4

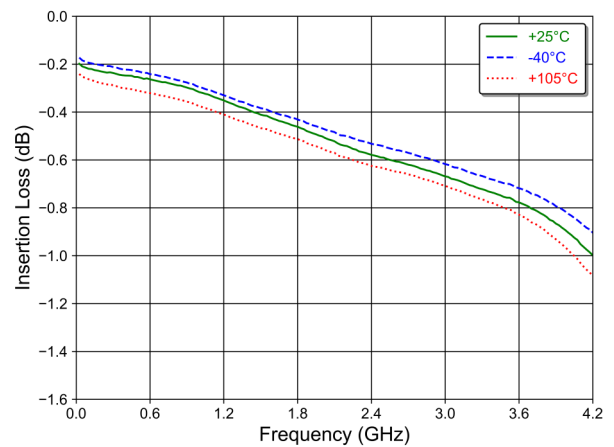

# High Power High Linearity SP4T Switch DC - 4.2 GHz



MASW-011127  
Rev. V1

Typical Performance Curves:  $P_{IN} = -10$  dBm,  $V_{CC1} = 5$  V,  $V_{CC2} = -3.4$  V,  $Z_0 = 50$   $\Omega$

RF1 Return Loss<sup>9</sup>, RFCOM-RF1

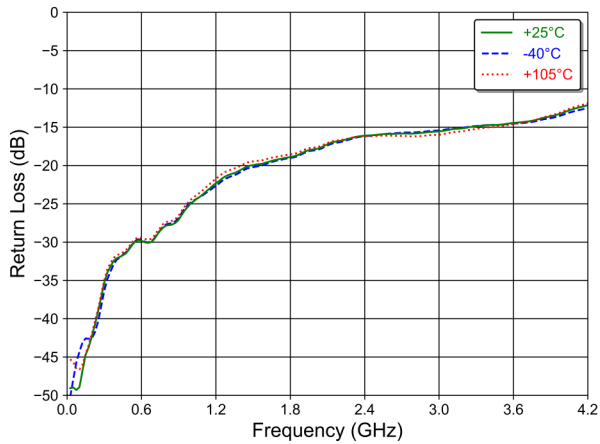

RF2 Return Loss<sup>9</sup>, RFCOM-RF2

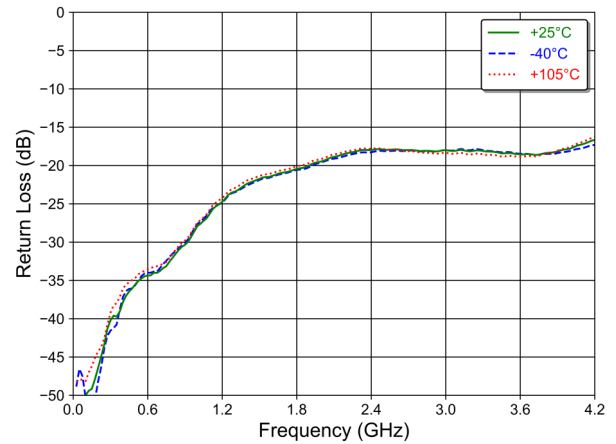

RF3 Return Loss<sup>9</sup>, RFCOM-RF3

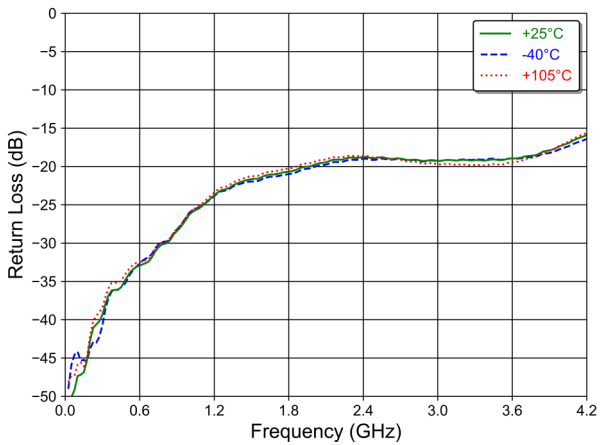

RF4 Return Loss<sup>9</sup>, RFCOM-RF4

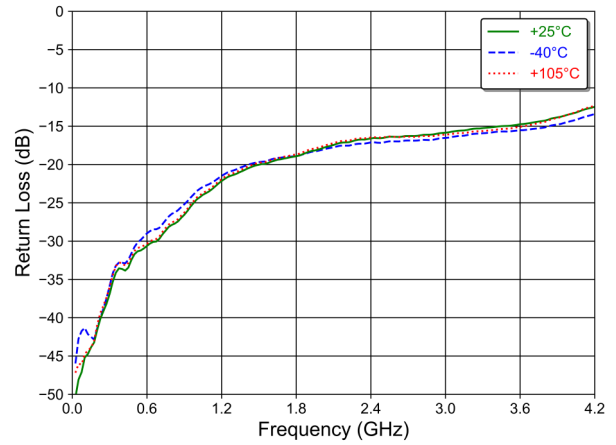



# High Power High Linearity SP4T Switch DC - 4.2 GHz



MASW-011127  
Rev. V1

Typical Performance Curves:  $P_{IN} = -10$  dBm,  $V_{CC1} = 5$  V,  $V_{CC2} = -3.4$  V,  $Z_0 = 50 \Omega$

Switch Isolation<sup>9</sup>, RFCOM-RF1

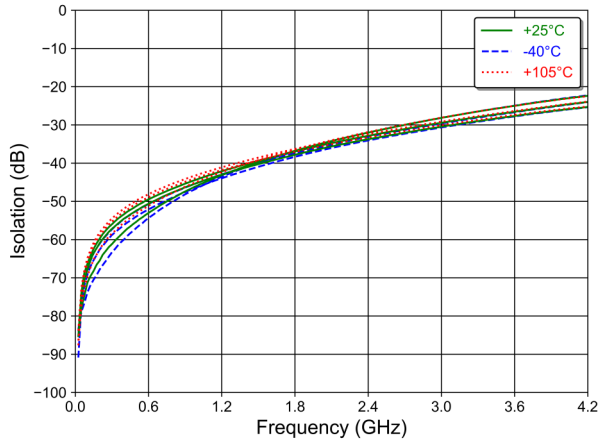

Switch Isolation<sup>9</sup>, RFCOM-RF2

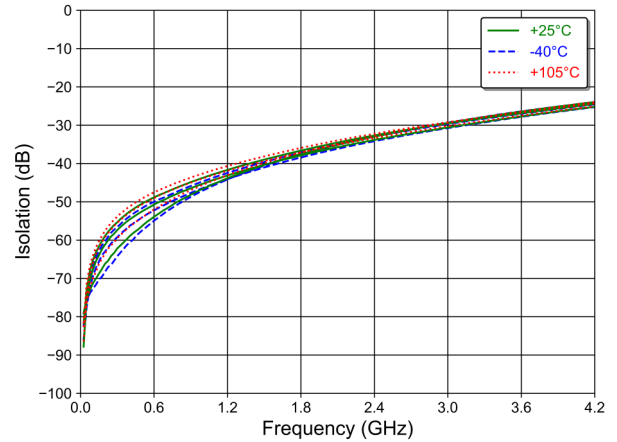

Switch Isolation<sup>9</sup>, RFCOM-RF3

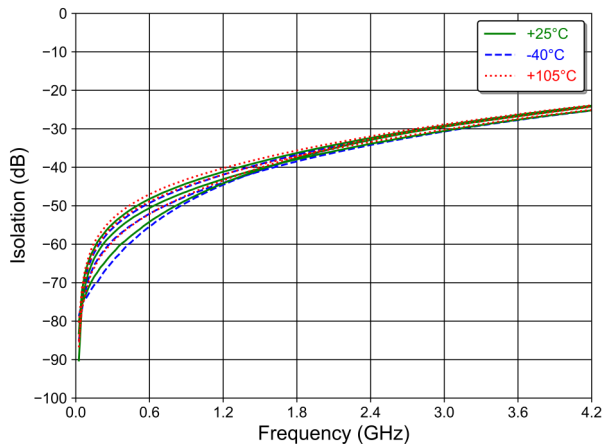

Switch Isolation<sup>9</sup>, RFCOM-RF4

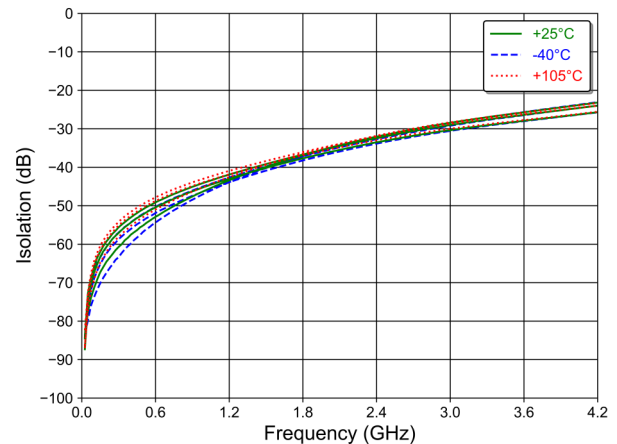

Compression P0.1dB<sup>9</sup>

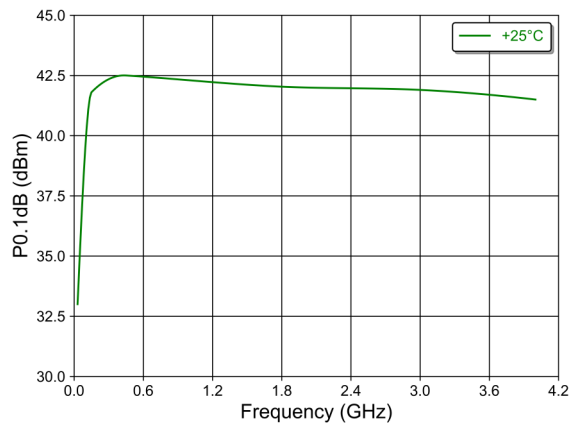

9. For insertion loss, isolation, and compression plots, RF trace and connector losses are de-embedded.

# High Power High Linearity SP4T Switch DC - 4.2 GHz



MASW-011127  
Rev. V1

## Lead-Free 4 mm 20-Lead PQFN<sup>†</sup>

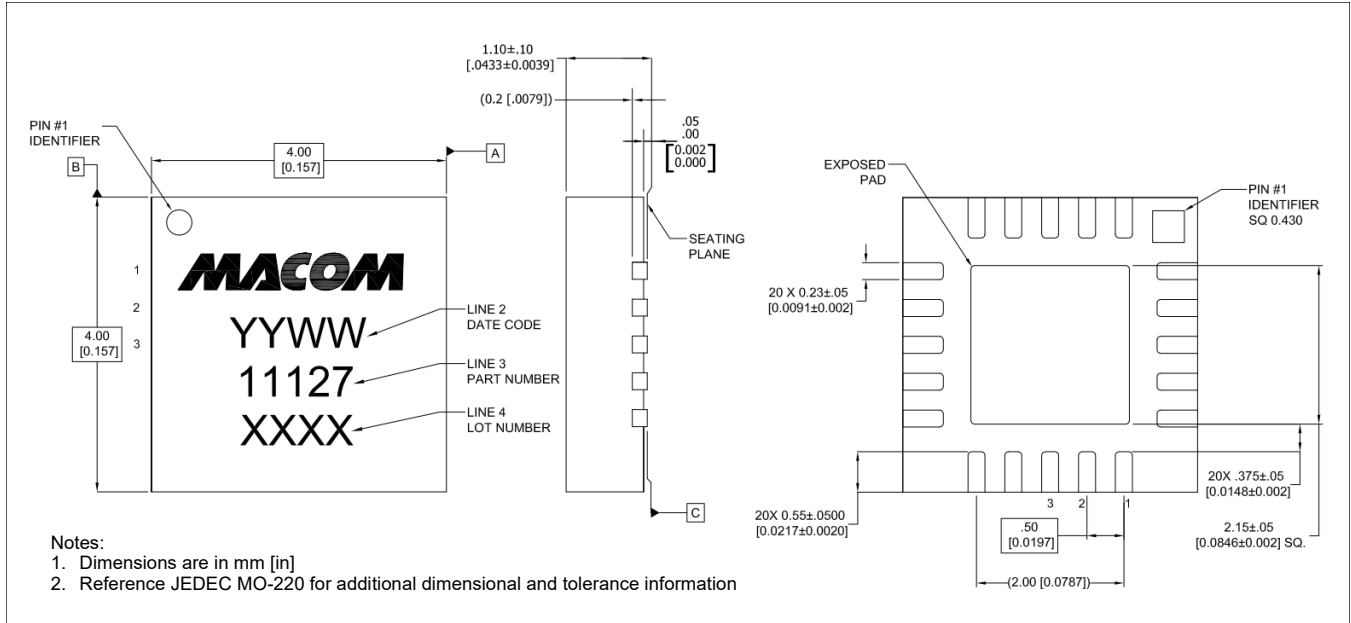

<sup>†</sup> Reference Application Note S2083 for lead-free solder reflow recommendations.  
Meets JEDEC moisture sensitivity level 1 requirements in accordance to JEDEC J-STD-020D.  
Plating is Sn over Cu.

MACOM Technology Solutions Inc. ("MACOM"). All rights reserved.

These materials are provided in connection with MACOM's products as a service to its customers and may be used for informational purposes only. Except as provided in its Terms and Conditions of Sale or any separate agreement, MACOM assumes no liability or responsibility whatsoever, including for (i) errors or omissions in these materials; (ii) failure to update these materials; or (iii) conflicts or incompatibilities arising from future changes to specifications and product descriptions, which MACOM may make at any time, without notice. These materials grant no license, express or implied, to any intellectual property rights.

THESE MATERIALS ARE PROVIDED "AS IS" WITH NO WARRANTY OR LIABILITY, EXPRESS OR IMPLIED, RELATING TO SALE AND/OR USE OF MACOM PRODUCTS INCLUDING FITNESS FOR A PARTICULAR PURPOSE, MERCHANTABILITY, INFRINGEMENT OF INTELLECTUAL PROPERTY RIGHT, ACCURACY OR COMPLETENESS, OR SPECIAL, INDIRECT, INCIDENTAL, OR CONSEQUENTIAL DAMAGES WHICH MAY RESULT FROM USE OF THESE MATERIALS.

MACOM products are not intended for use in medical, lifesaving or life sustaining applications. MACOM customers using or selling MACOM products for use in such applications do so at their own risk and agree to fully indemnify MACOM for any damages resulting from such improper use or sale.