

10 W Antenna Switch with Receive Limiter 1.5 - 4.0 GHz



MASW-010370

Rev. V2

Features

- 0.5 dB T_x Path Insertion Loss @ 3 GHz
- 10 W Peak Power Handling @ 3 GHz
- 37 dB T_x to R_x Isolation @ 3 GHz
- 0.85 dB R_x Path Insertion Loss @ 3 GHz
- Integrated Limiter Diode for R_x Protection
- Integrated Bias Circuit for Easy Control
- Lead-Free 3 mm 16-lead PQFN Package
- RoHS* Compliant and 260°C Reflow Compatible

Applications

- Aviation and Weather Radar

Description

The MASW-010370 is a fully integrated 10 W PIN diode antenna switch assembled in a lead-free 3 mm 16-lead PQFN plastic package.

This module is designed to handle 10 W pulsed signals at both the T_x and Antenna ports. Low loss on the transmit side improves the overall efficiency of the transmit chain. The receive section soft limits the receive signal prior to the receive filter, which would reflect out-of-band interfering signals.

MASW-010370 can be used in conjunction with MACOM's MADL-011008 diode limiter, which would be located after the receive filter to fully protect the R_x LNA.

Ordering Information^{1,2}

Part Number	Package
MASW-010370	bulk
MASW-010370-TR0500	500 piece reel
MASW-010370-001SMB	Sample Test Board

1. Reference Application Note M513 for reel size information.

Functional Block Diagram

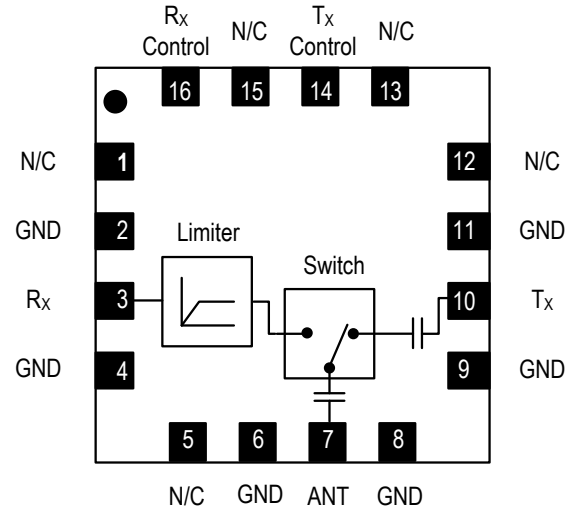

Pin Designations

Pin #	Function
1, 5, 12, 13, 15	No Connection
2, 4, 6, 8, 9, 11	Ground
3	R_x^2
7	Antenna
10	T_x
14	T_x Control
16	R_x Control
17	Pad ³

2. An external DC block is required at the R_x pin.

3. The exposed pad centered on the package bottom must be connected to RF, DC and thermal ground.

* Restrictions on Hazardous Substances, compliant to current RoHS EU directive.

10 W Antenna Switch with Receive Limiter

1.5 - 4.0 GHz



MASW-010370

Rev. V2

Electrical Specifications: $P_{IN} = 0$ dBm, $T_A = 25^\circ\text{C}$, $Z_0 = 50 \Omega$

T _X Mode (T _X Control = -5 V, R _X Control = +5 V)					
Parameter	Test Conditions	Units	Min.	Typ.	Max.
Insertion Loss	1.5 - 4.0 GHz	dB	—	0.6	—
	2.7 GHz			—	0.6
	2.3 - 3.0 GHz			0.5	—
T _X to R _X Isolation	1.5 - 4.0 GHz	dB	—	39	—
	3.0 GHz		35	—	
	2.3 - 3.0 GHz		—	38	
Input Return Loss	1.5 - 4.0 GHz	dB	—	25	—
	2.3 - 3.0 GHz			29	
Output Return Loss	1.5 - 4.0 GHz	dB	—	24	—
	2.3 - 3.0 GHz			25	
T _{ON}	50% control to 90% RF @ 3 GHz	ns	—	56	—
T _{RISE}	10% to 90% RF @ 3 GHz	ns	—	56	—
T _{OFF}	50% control to 10% RF @ 3 GHz	ns	—	22	—
T _{FALL}	90% to 10% RF @ 3 GHz	ns	—	19	—
T _X Control	-5 V Current	mA	-50	—	-10
R _X Control	+5 V Current	mA	10	—	50

R _X Mode (T _X Control = +5 V, R _X Control = -5 V)					
Parameter	Test Conditions	Units	Min.	Typ.	Max.
Insertion Loss	1.5 - 4.0 GHz	dB	—	0.90	—
	2.7 GHz			—	1.0
	2.3 - 3.0 GHz			0.85	—
ANT to T _X Isolation	1.5 - 4.0 GHz	dB	—	24	—
	3.0 GHz		22	—	
	2.3 - 3.0 GHz		—	23	
Input Return Loss	1.5 - 4.0 GHz	dB	—	20	—
	2.3 - 3.0 GHz			22	
Output Return Loss	1.5 - 4.0 GHz	dB	—	26	—
	2.3 - 3.0 GHz			26	
T _{ON}	50% control to 90% RF @ 3 GHz	ns	—	167	—
T _{RISE}	10% to 90% RF @ 3 GHz	ns	—	48	—
T _{OFF}	50% control to 10% RF @ 3 GHz	ns	—	53	—
T _{FALL}	90% to 10% RF @ 3 GHz	ns	—	43	—
T _X Control	+5 V Current	mA	0	—	1
R _X Control	-5 V Current	mA	-50	—	-10
R _X Limiter Peak P _{OUT}	10 W Pulsed P _{IN} @ 3 GHz 10 μs, 10% duty cycle	dBm	—	26	—

10 W Antenna Switch with Receive Limiter 1.5 - 4.0 GHz



MASW-010370

Rev. V2

Bias Table

Mode	T _X Control	R _X Control
T _X	-5 V	+5 V
R _X	+5 V	-5 V

Sample Board

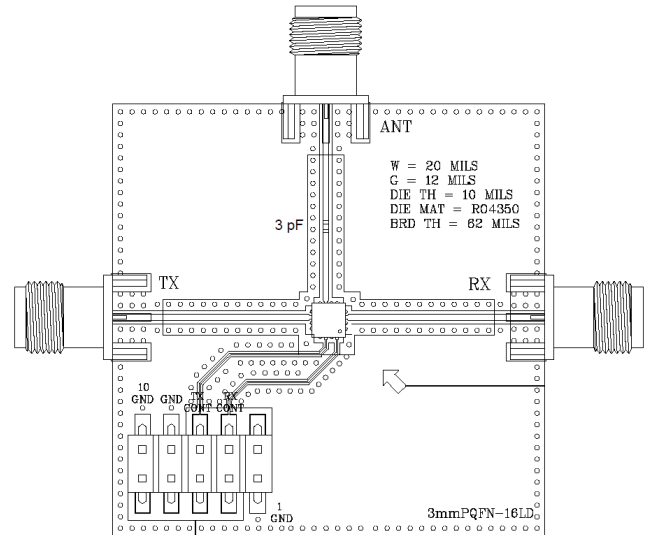

Absolute Maximum Ratings^{4,5}

Parameter	Absolute Maximum
T _X Control Voltage	-6 V ≤ T _X Control ≤ +6 V
R _X Control Voltage	-6 V ≤ R _X Control ≤ +6 V
T _X Peak Incident Power	20 W, 10 μs pulse width, 10% duty cycle
R _X Peak Incident Power	12 W, 10 μs pulse width, 10% duty cycle
Operating Temperature	-40°C to +85°C
Storage Temperature	-55°C to +150°C

- Exceeding any one or combination of these limits may cause permanent damage to this device.
- MACOM does not recommend sustained operation near these survivability limits.

Handling Procedures

Please observe the following precautions to avoid damage:

Static Sensitivity

These electronic devices are sensitive to electrostatic discharge (ESD) and can be damaged by static electricity. Proper ESD control techniques should be used when handling these Class 1A (HBM) & Class C4 (CDM) devices.

Typical Performance Curve

Limiting Diode Power Limiting Curve^{6,7}

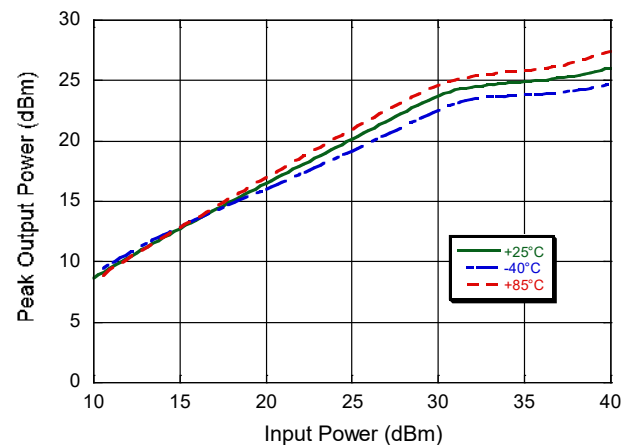

- Frequency = 3 GHz, 10 μs pulse width, 10% duty cycle, Z₀ = 50 Ω.
- For improved limiting, add MADL-011008 after R_X port.

10 W Antenna Switch with Receive Limiter 1.5 - 4.0 GHz



MASW-010370

Rev. V2

Typical Performance Curves T_x Mode

Insertion Loss vs. Frequency

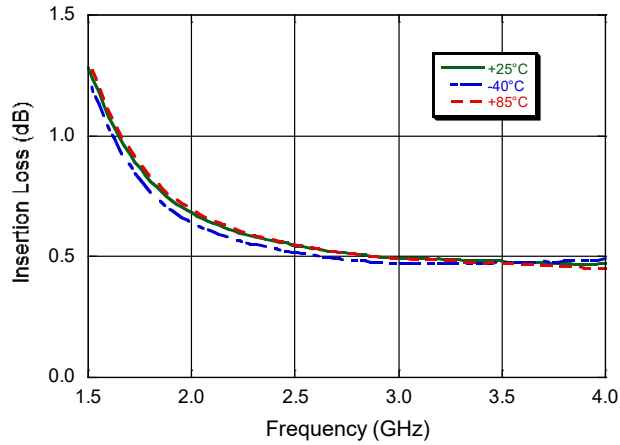

T_x to R_x Isolation vs. Frequency

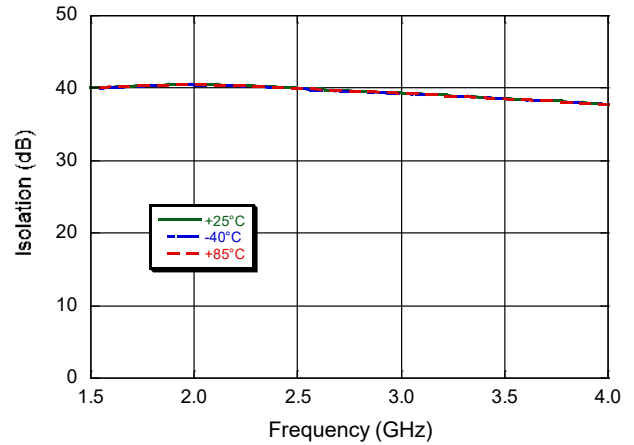

Input Return Loss vs. Frequency

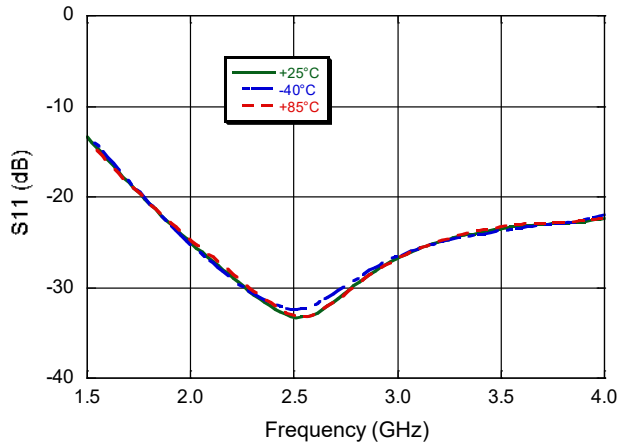

Output Return Loss vs. Frequency

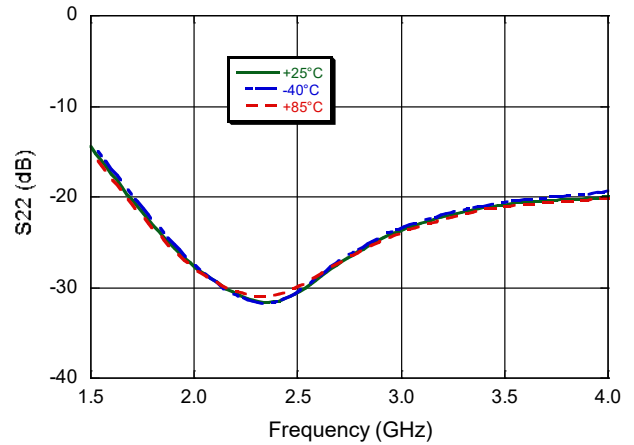

Typical Performance Curves R_x Mode

Insertion Loss vs. Frequency

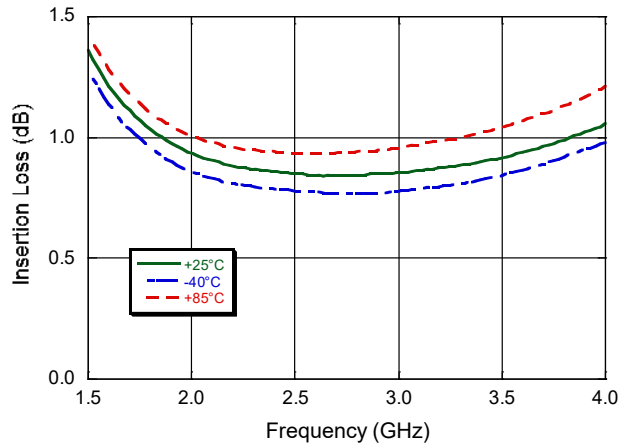

ANT to T_x Isolation vs. Frequency

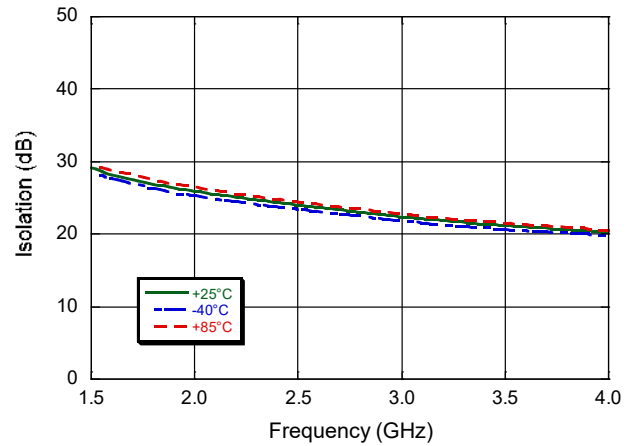

Input Return Loss vs. Frequency

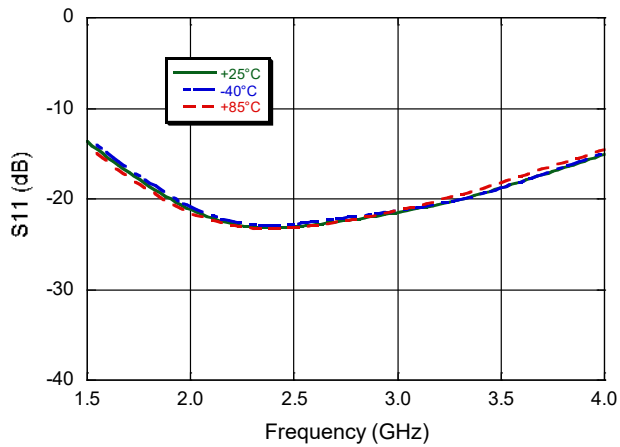

Output Return Loss vs. Frequency

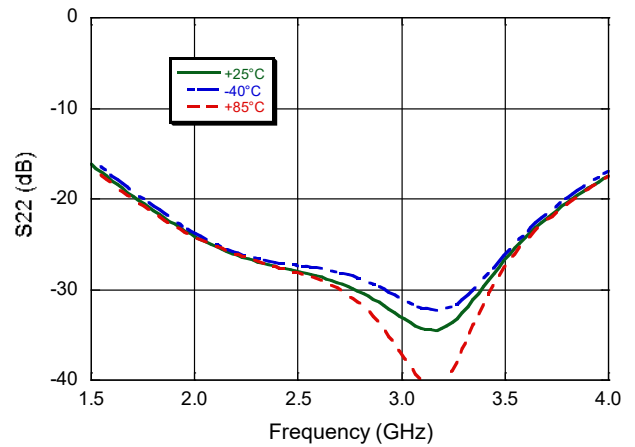

10 W Antenna Switch with Receive Limiter 1.5 - 4.0 GHz



MASW-010370

Rev. V2

Lead-Free 3 mm 16-Lead PQFN†

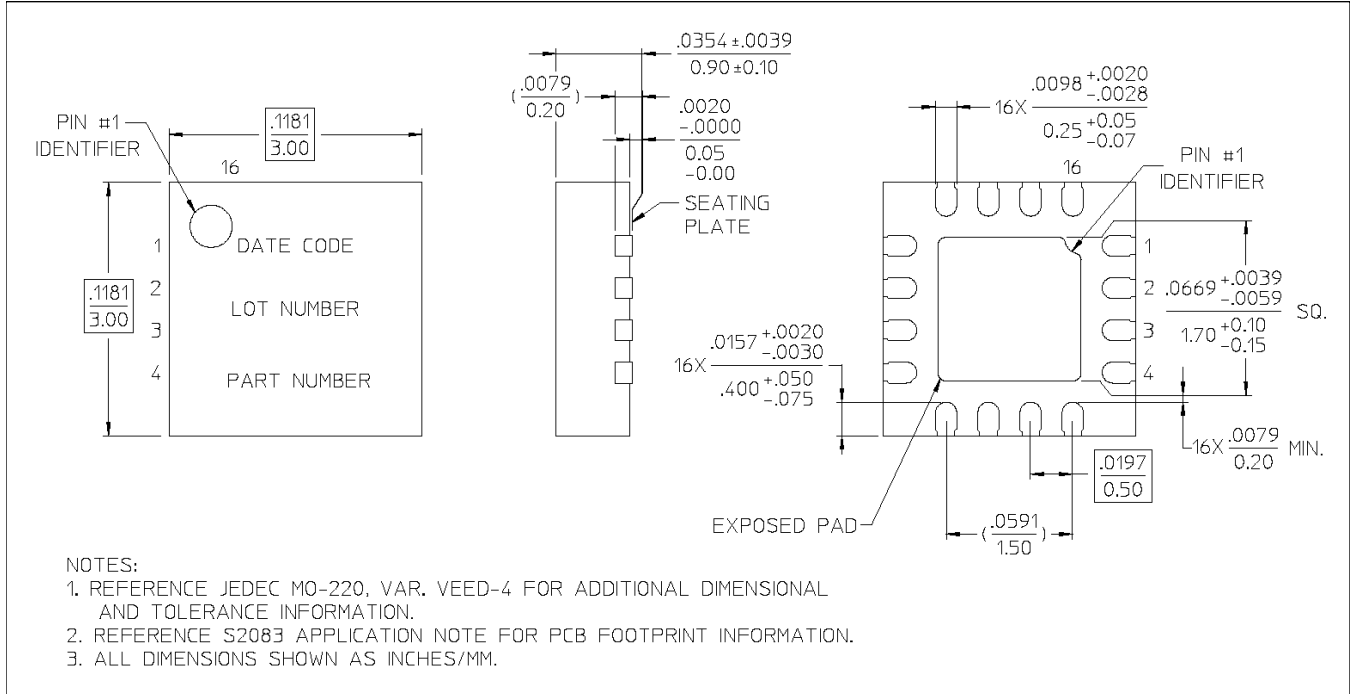

† Reference Application Note S2083 for lead-free solder reflow recommendations.
Meets JEDEC moisture sensitivity level 1 requirements.
Plating is 100% tin over copper.

10 W Antenna Switch with Receive Limiter

1.5 - 4.0 GHz



MASW-010370

Rev. V2

MACOM Technology Solutions Inc. ("MACOM"). All rights reserved.

These materials are provided in connection with MACOM's products as a service to its customers and may be used for informational purposes only. Except as provided in its Terms and Conditions of Sale or any separate agreement, MACOM assumes no liability or responsibility whatsoever, including for (i) errors or omissions in these materials; (ii) failure to update these materials; or (iii) conflicts or incompatibilities arising from future changes to specifications and product descriptions, which MACOM may make at any time, without notice. These materials grant no license, express or implied, to any intellectual property rights.

THESE MATERIALS ARE PROVIDED "AS IS" WITH NO WARRANTY OR LIABILITY, EXPRESS OR IMPLIED, RELATING TO SALE AND/OR USE OF MACOM PRODUCTS INCLUDING FITNESS FOR A PARTICULAR PURPOSE, MERCHANTABILITY, INFRINGEMENT OF INTELLECTUAL PROPERTY RIGHT, ACCURACY OR COMPLETENESS, OR SPECIAL, INDIRECT, INCIDENTAL, OR CONSEQUENTIAL DAMAGES WHICH MAY RESULT FROM USE OF THESE MATERIALS.

MACOM products are not intended for use in medical, lifesaving or life sustaining applications. MACOM customers using or selling MACOM products for use in such applications do so at their own risk and agree to fully indemnify MACOM for any damages resulting from such improper use or sale.