

## Avionics Pulsed Power Transistor 850W, 1025-1150 MHz, 10μs Pulse, 1% Duty

Rev. V1

### Features

- NPN silicon microwave power transistors
- Common base configuration
- Broadband Class C operation
- High efficiency inter-digitized geometry
- Diffused emitter ballasting resistors
- Gold metallization system
- Internal input and output impedance matching
- Hermetic metal/ceramic package
- RoHS compliant

### Outline Drawing

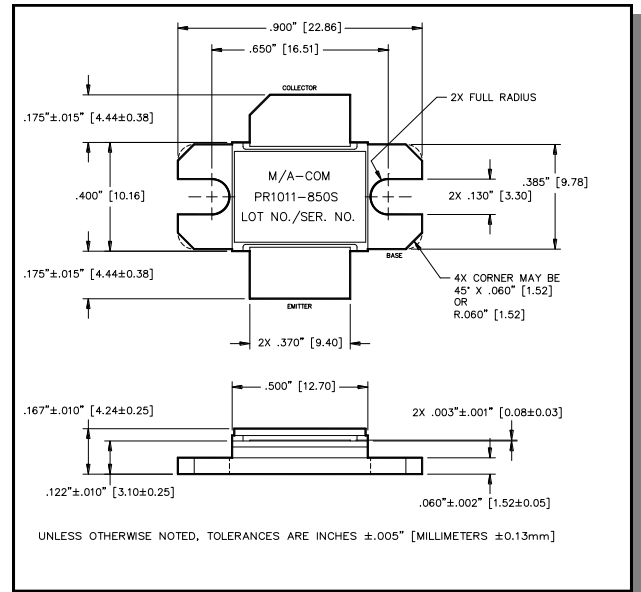

### Absolute Maximum Ratings at 25°C

Parameter	Symbol	Rating	Units
Collector-Emitter Voltage	$V_{CES}$	80	V
Emitter-Base Voltage	$V_{EBO}$	3.0	V
Collector Current (Peak)	$I_C$	250	A
Power Dissipation @ +25°C	$P_{TOT}$	11.6	kW
Storage Temperature	$T_{STG}$	-65 to +200	°C
Junction Temperature	$T_J$	200	°C

### Electrical Specifications: $T_C = 25 \pm 5^\circ\text{C}$ (Room Ambient )

Parameter	Test Conditions	Frequency	Symbol	Min	Max	Units
Collector-Emitter Breakdown Voltage	$I_C = 250\text{mA}$		$BV_{CES}$	80	-	V
Collector-Emitter Leakage Current	$V_{CE} = 50\text{V}$		$I_{CES}$	-	30	mA
Thermal Resistance	$V_{CC}=50\text{V}$ , $P_{out}=850\text{W}$	$F = 1025, 1090, 1150\text{ MHz}$	$R_{TH(JC)}$	-	0.015	°C/W
Input Power	$V_{CC}=50\text{V}$ , $P_{out}=850\text{W}$	$F = 1025, 1090, 1150\text{ MHz}$	$P_{IN}$	-	141	W
Power Gain	$V_{CC}=50\text{V}$ , $P_{out}=850\text{W}$	$F = 1025, 1090, 1150\text{ MHz}$	$G_P$	7.8	-	dB
Collector Efficiency	$V_{CC}=50\text{V}$ , $P_{out}=850\text{W}$	$F = 1025, 1090, 1150\text{ MHz}$	$\eta_C$	42	-	%
Input Return Loss	$V_{CC}=50\text{V}$ , $P_{out}=850\text{W}$	$F = 1025, 1090, 1150\text{ MHz}$	RL	-	-9	dB
Load Mismatch Tolerance	$V_{CC}=50\text{V}$ , $P_{out}=850\text{W}$	$F = 1025\text{ MHz}$	VSWR-T	-	5:1	-
Load Mismatch Stability *	$V_{CC}=50\text{V}$ , $P_{out}=850\text{W}$	$F = 1025, 1090, 1150\text{ MHz}$	VSWR-S	-	1.5:1	-

\* All spurious signals shall be < -60dBc below carrier, except  $F = F_0 \pm \frac{1}{2} F_0$  shall be < -40dBc

## Typical RF Performance

Freq. (MHz)	Pin (W)	Pout (W)	Gain (dB)	$\Delta$ Gain (dB)	Ic (A)	Eff (%)	RL (dB)	VSWR-S (1.5:1)	VSWR-T (5:1)	P1dB Overdrive	
										Pout	$\Delta$ Po
1025	116	850	8.67	-	35.3	48.2	-18.3	S	P	974	0.59
1090	117	850	8.61	-	33.9	50.3	-16.3	S	-	1014	0.76
1150	112	850	8.42	0.25	32.1	53.0	-21.1	S	-	997	0.69

Note:  $\Delta$ Po(dB) is the difference between Pout at 1dB overdrive and Pout at Pout=850W.

## Gain vs. Frequency

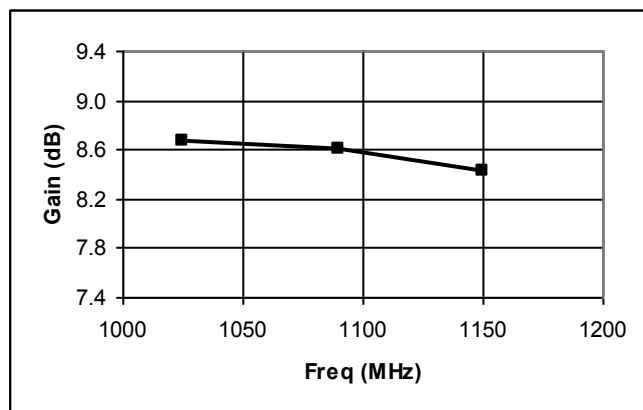

## Collector Efficiency vs. Frequency

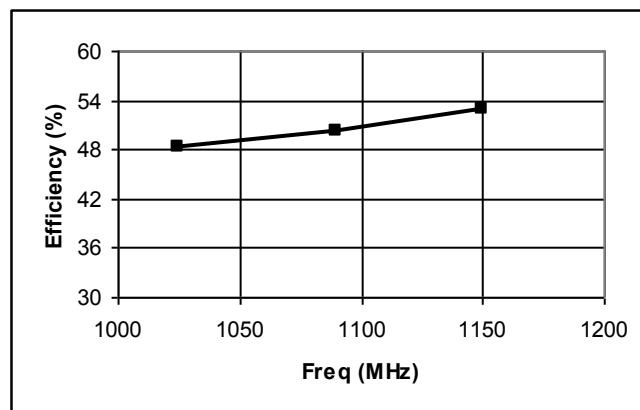

## RF Power Transfer Curve (Output Power Vs. Input Power)

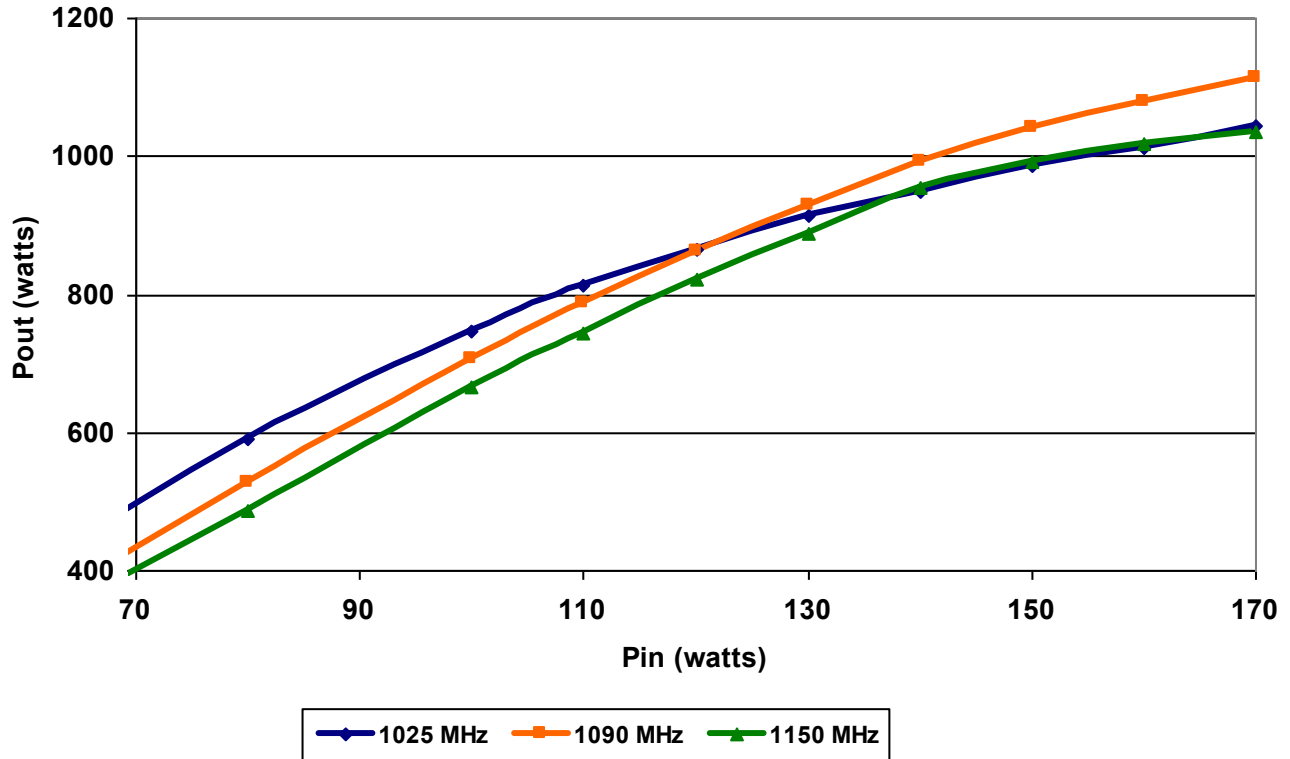

## Broadband Test Fixture Impedance

F (MHz)	Z <sub>IF</sub> ( $\Omega$ )	Z <sub>OF</sub> ( $\Omega$ )
1025	1.7 - j1.8	0.8 - j1.3
1090	1.4 - j1.2	0.8 - j1.0
1150	1.3 - j0.7	0.8 - j0.8

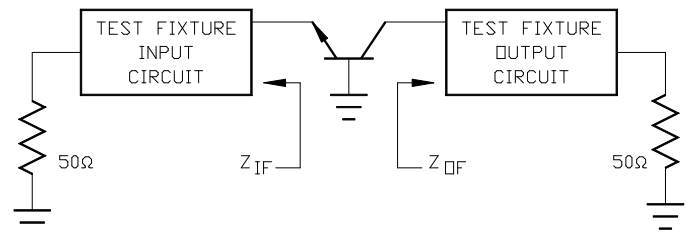

## Avionics Pulsed Power Transistor 850W, 1025-1150 MHz, 10µs Pulse, 1% Duty

Rev. V1

### Test Fixture Circuit Dimensions

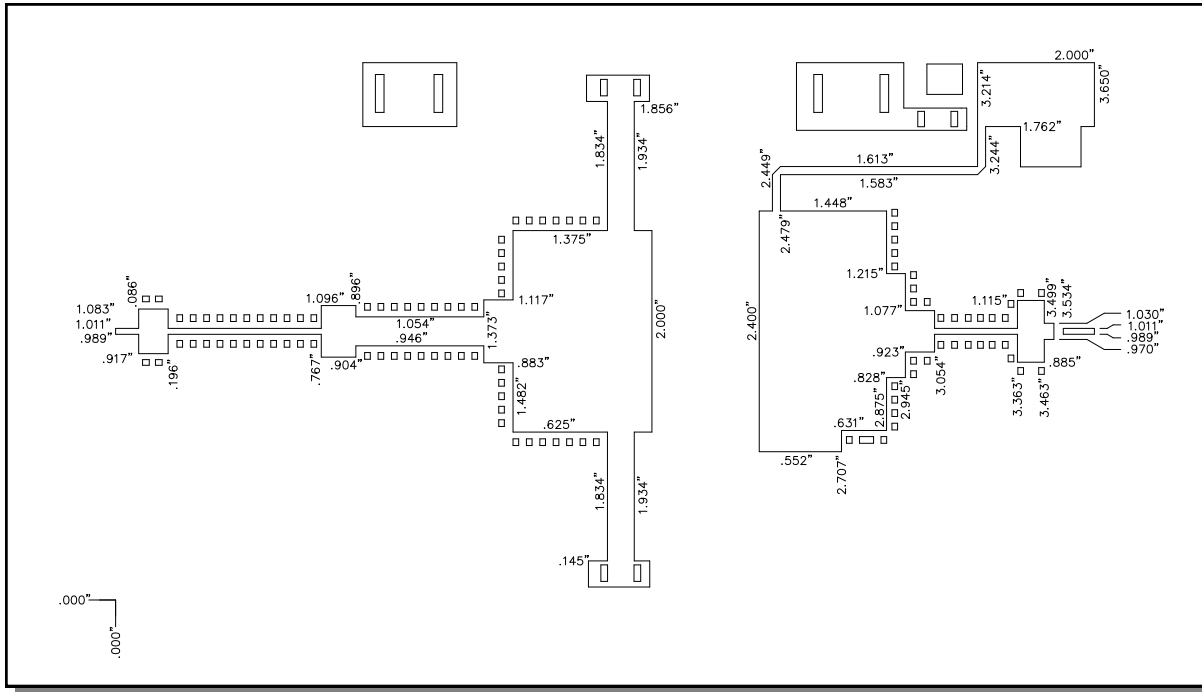

### Test Fixture Assembly

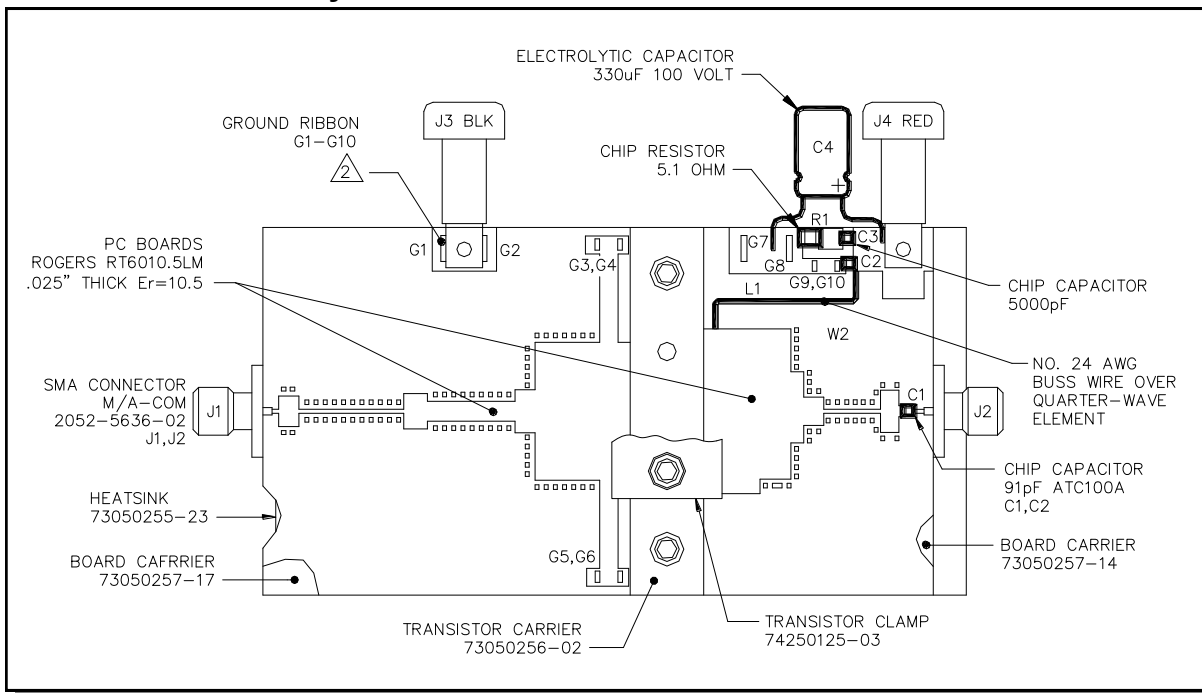

M/A-COM Technology Solutions Inc. All rights reserved.

Information in this document is provided in connection with M/A-COM Technology Solutions Inc ("MACOM") products. These materials are provided by MACOM as a service to its customers and may be used for informational purposes only. Except as provided in MACOM's Terms and Conditions of Sale for such products or in any separate agreement related to this document, MACOM assumes no liability whatsoever. MACOM assumes no responsibility for errors or omissions in these materials. MACOM may make changes to specifications and product descriptions at any time, without notice. MACOM makes no commitment to update the information and shall have no responsibility whatsoever for conflicts or incompatibilities arising from future changes to its specifications and product descriptions. No license, express or implied, by estoppel or otherwise, to any intellectual property rights is granted by this document.

THESE MATERIALS ARE PROVIDED "AS IS" WITHOUT WARRANTY OF ANY KIND, EITHER EXPRESS OR IMPLIED, RELATING TO SALE AND/OR USE OF MACOM PRODUCTS INCLUDING LIABILITY OR WARRANTIES RELATING TO FITNESS FOR A PARTICULAR PURPOSE, CONSEQUENTIAL OR INCIDENTAL DAMAGES, MERCHANTABILITY, OR INFRINGEMENT OF ANY PATENT, COPYRIGHT OR OTHER INTELLECTUAL PROPERTY RIGHT. MACOM FURTHER DOES NOT WARRANT THE ACCURACY OR COMPLETENESS OF THE INFORMATION, TEXT, GRAPHICS OR OTHER ITEMS CONTAINED WITHIN THESE MATERIALS. MACOM SHALL NOT BE LIABLE FOR ANY SPECIAL, INDIRECT, INCIDENTAL, OR CONSEQUENTIAL DAMAGES, INCLUDING WITHOUT LIMITATION, LOST REVENUES OR LOST PROFITS, WHICH MAY RESULT FROM THE USE OF THESE MATERIALS.

MACOM products are not intended for use in medical, lifesaving or life sustaining applications. MACOM customers using or selling MACOM products for use in such applications do so at their own risk and agree to fully indemnify MACOM for any damages resulting from such improper use or sale.