

Features

- Saturated Power: 18 W
- Drain Efficiency: 70%
- Small Signal Gain: 12.5 dB
- Lead-Free Air Cavity Ceramic Package
- RoHS* Compliant

Applications

- Avionics - TACAN, DME, IFF
- Military Radio
- L, S, C-band Radar
- Electronic Warfare
- ISM
- General Amplification

Description

The MAPC-A3006-AB/AS is a 18 W packaged, unmatched transistor utilizing a high performance, 0.15 μm GaN on SiC production process. This transistor supports both defense and commercial related applications.

Offered in a thermally-enhanced flange package, the MAPC-A3006-AB/AS provides superior performance under CW operation allowing customers to improve SWaP-C benchmarks in their next generation systems.

Typical RF Performance:

- Measured at CW = P_{SAT} , defined at $I_{\text{GS}} = 0.36 \text{ mA}$, $V_{\text{DS}} = 28 \text{ V}$, $I_{\text{DQ}} = 100 \text{ mA}$, $T_{\text{C}} = 25^{\circ}\text{C}$

Frequency (GHz)	Output Power (dBm)	Gain (dB)	η_{D} (%)
3.4	43.8	14.2	74.4
3.7	42.5	12.5	70.5
4.0	42.3	12.2	56.4



440196



440166

Functional Schematic

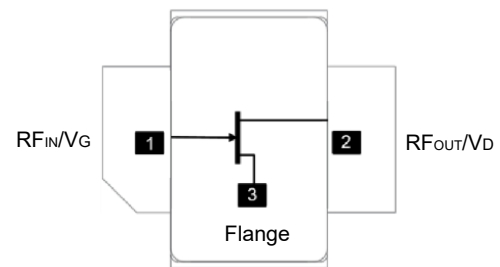

Pin Configuration

Pin #	Pin Name	Function
1	RF _{IN} / V _G	RF Input / Gate
2	RF _{OUT} / V _D	RF Output / Drain
3	Flange ¹	Ground / Source

1. The flange on the package bottom must be connected to RF, DC and thermal ground.

Ordering Information

Part Number	MOQ Increment
MAPC-A3006-AB000	Bulk Quantity: Boltdown
MAPC-A3006-AS000	Bulk Quantity: Earless
MAPC-A3006-ABSB1	Sample Board: Both

* Restrictions on Hazardous Substances, compliant to current RoHS EU directive.

RF Electrical Specifications: Frequency = 3.7 GHz, P_{SAT} @ I_{GS} = 0.36 mA, T_A = +25°C, V_{DS} = 28 V, I_{DQ} = 100 mA, Low Power Gain tested at Input Power of 10 dBm

Parameter	Conditions	Symbol	Min.	Typ.	Max.	Units
Saturated Power	V _{DD} = 28 V, CW	P _{SAT}	14.8	17.5	-	W
Drain Efficiency	V _{DD} = 28 V, CW	η _{SAT}	74	77	-	%
Low Power Gain	V _{DD} = 28 V, P _{IN} = 10 dBm, CW	G _{SS}	15.3	16.2	-	dB

Note: Final testing and screening for all transistor sales is performed using the MAPC-A3006-ABSB1 at 3.7 GHz.

Absolute Maximum Ratings^{2,3}

Parameter	Absolute Maximum
Drain-Source Voltage	84 V
Gate Voltage	-10, +2 V
Drain Current	4.6 A
Gate Current	3.6 mA
Input Power	30.5 dBm
Storage Temperature	-55°C to +150°C
Mounting Temperature	+245°C
Junction Temperature ^{3,4,5}	+225°C
Operating Temperature	-40°C to +85°C

- Exceeding any one or combination of these limits may cause permanent damage to this device.
- MACOM does not recommend sustained operation near these survivability limits.
- Operating at nominal conditions with T_J ≤ +225 °C will ensure MTTF > 1 x 10⁶ hours.
- Junction Temperature (T_J) = T_C + Θ_{Jc} * (V * I)
Typical thermal resistance (Θ_{Jc}) = 7.83 °C/W for CW.
 - For T_C = +25°C,
T_J = 91 °C @ P_{DISS} = 8.4 W
 - For T_C = +85°C,
T_J = 153 °C @ P_{DISS} = 8.7 W

Handling Procedures

Please observe the following precautions to avoid damage:

Static Sensitivity

These electronic devices are sensitive to electrostatic discharge (ESD) and can be damaged by static electricity. Proper ESD control techniques should be used when handling these devices.

Evaluation Test Fixture and Recommended Tuning Solution, 3.4 - 4.0 GHz

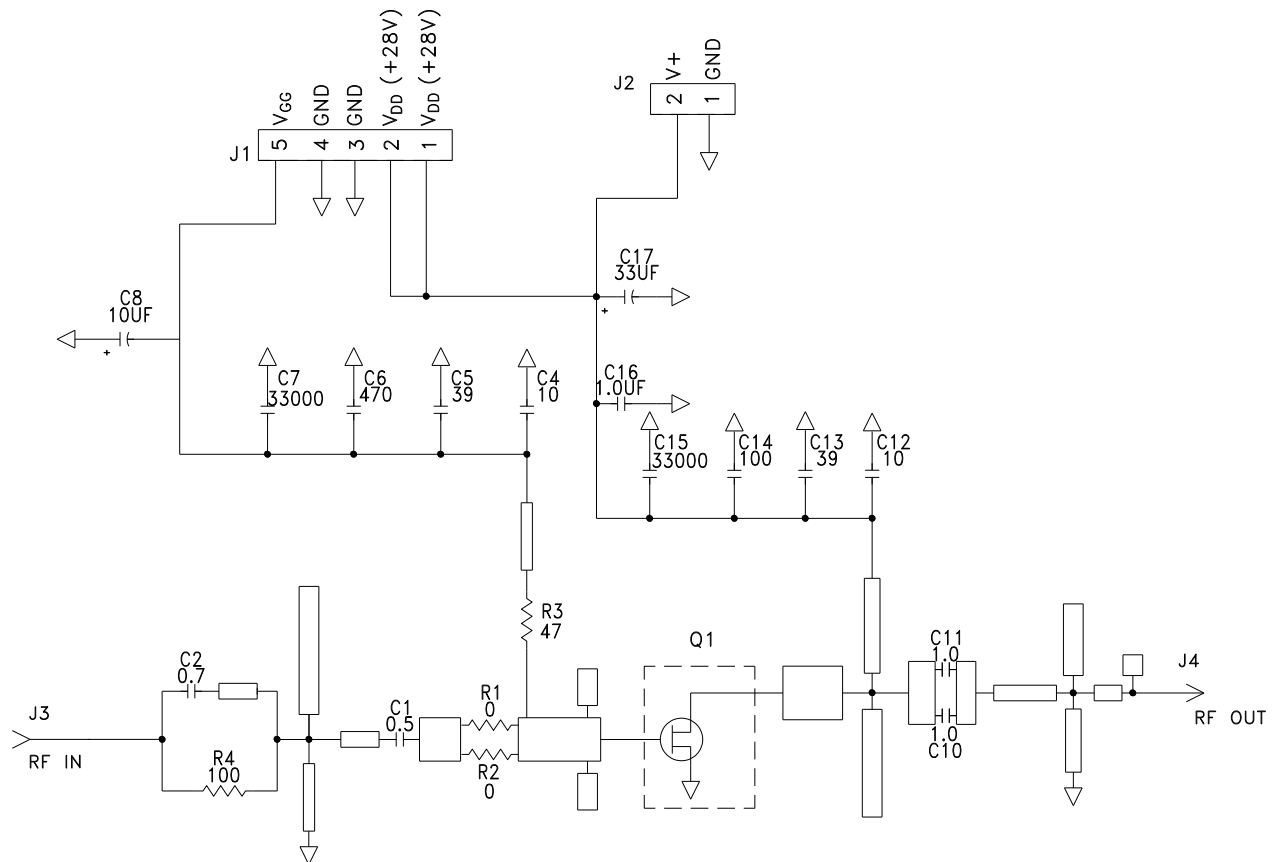

Description

Parts measured on evaluation board (20-mil thick RO4350). Matching is provided using a combination of lumped elements and transmission lines as shown in the simplified schematic above. Recommended tuning solution component placement, transmission lines, and details are shown on the next page.

Biasing Sequence

Bias ON

1. Ensure RF is turned off
2. Apply pinch-off voltage of -5 V to the gate
3. Apply nominal drain voltage
4. Bias gate to desired quiescent drain current
5. Apply RF

Bias OFF

1. Turn RF off
2. Apply pinch-off voltage of -5 V to the gate
3. Turn-off drain voltage
4. Turn-off gate voltage

Evaluation Test Fixture and Recommended Tuning Solution, 3.4 - 4.0 GHz

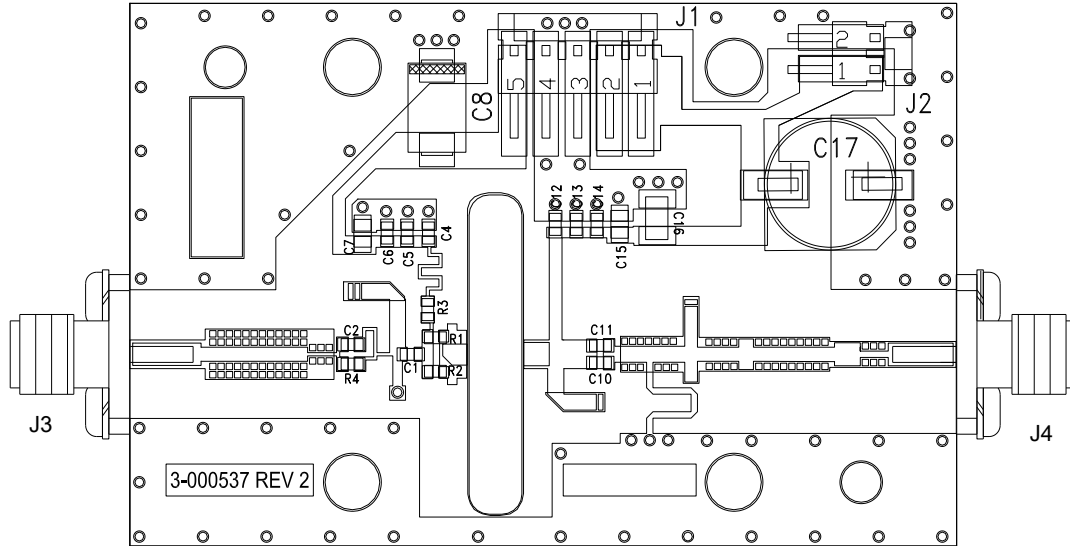

Assembly Parts List

Reference Designator	Description	Qty.
C1	Cap, 0.5 pF, ± 0.05 pF, 0603, ATC	1
C2	Cap, 0.7 pF, ± 0.1 pF, 0603, ATC	1
C4, C12	Cap, 10 pF, $\pm 5\%$, 0603, ATC	2
C5, C13	Cap, 39 pF, $\pm 5\%$, 0603, ATC	2
C6	Cap, 470 pF, $\pm 5\%$, 100V, 0603	1
C7, C15	CAP, 33000 pF, 0805, 100V, X7R	2
C8	Cap, 10 μ F, 16V, Tantalum, 2312	1
C10, C11	Cap, 1 pF, ± 0.1 pF, 0603, ATC	2
C14	Cap, 100 pF, $\pm 5\%$, 0603, ATC	1
C16	Cap, 1 μ F, 100V, $\pm 10\%$, X7R, 1210	1
C17	Cap, 33 μ F, $\pm 20\%$, G CASE	1
R1, R2	Res, 0 Ω , $\pm 1\%$, 0603, 1/16W	2
R3	RES, 47 Ω , $\pm 1\%$, 0603, 1/16W	1
R4	RES, 100 Ω , $\pm 1\%$, 0603, 1/16W	1
J1	Header, 5POS, 0.1in Pitch, 105°C, 250V	1
J2	Header, 2POS, 0.1in Pitch, 105°C, 250V	1
J3, J4	SMA Connector, Panel Jack, Post Contact, DC-18GHz, 50 Ω , 0.05in	2
-	PCB, RO4350B, Er = 3.48, h = 20 mil	1
Q1	MAPC-A3006-AB/AS	1

Typical Performance Curves as Measured in the 3.4 - 4.0 GHz Evaluation Test Fixture
 CW, P_{SAT} @ $I_{GS} = 0.36$ mA, $V_{DS} = 28$ V, $I_{DQ} = 100$ mA, Frequency = 3.7 GHz (Unless Otherwise Noted)
 For Engineering Evaluation Only – This data does not Modify MACOM's Datasheet Limits.

Output Power vs. Temperature and Frequency

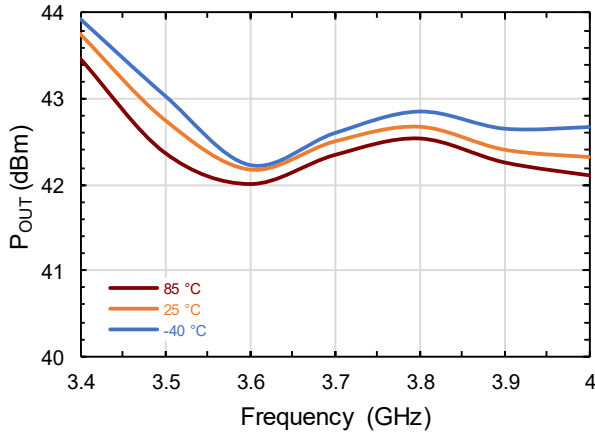

Drain Efficiency vs. Temperature and Frequency

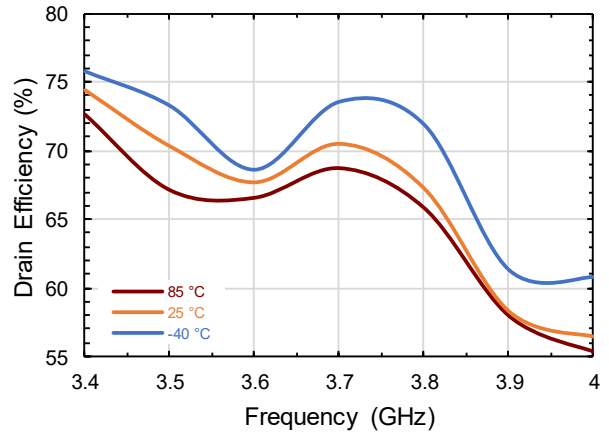

Drain Current vs. Temperature and Frequency

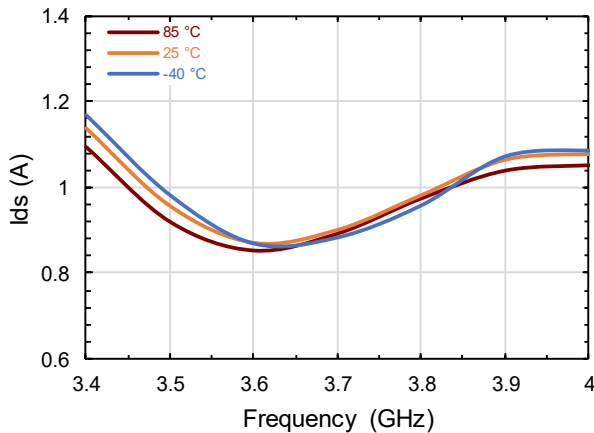

Gate Current vs. Temperature and Frequency

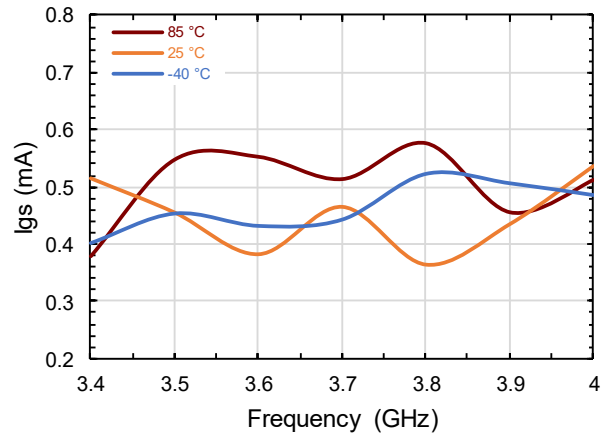

Large Signal Gain vs. Temperature and Frequency

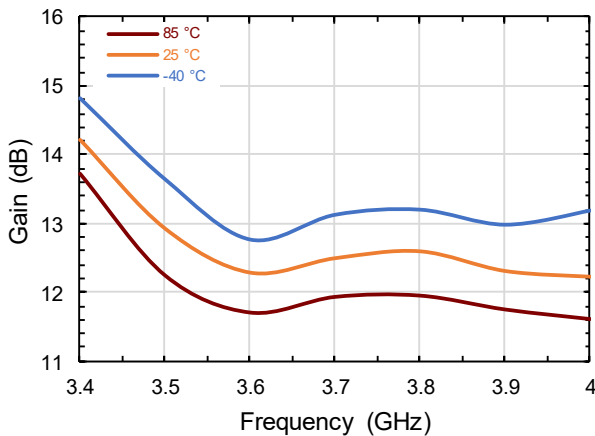

Typical Performance Curves as Measured in the 3.4 - 4.0 GHz Evaluation Test Fixture
 CW, P_{SAT} @ $I_{GS} = 0.36$ mA, $V_{DS} = 28$ V, $I_{DQ} = 100$ mA, Frequency = 3.7 GHz (Unless Otherwise Noted)
 For Engineering Evaluation Only – This data does not Modify MACOM's Datasheet Limits.

Output Power vs. V_{DS} and Frequency

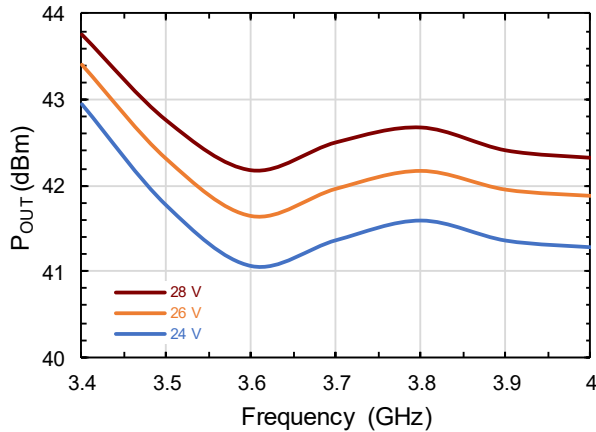

Drain Efficiency vs. V_{DS} and Frequency

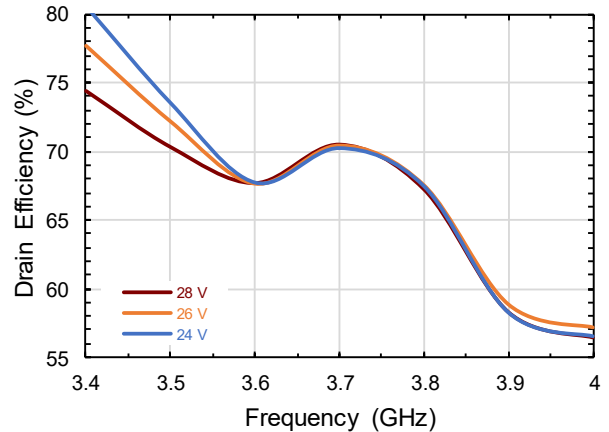

Drain Current vs. V_{DS} and Frequency

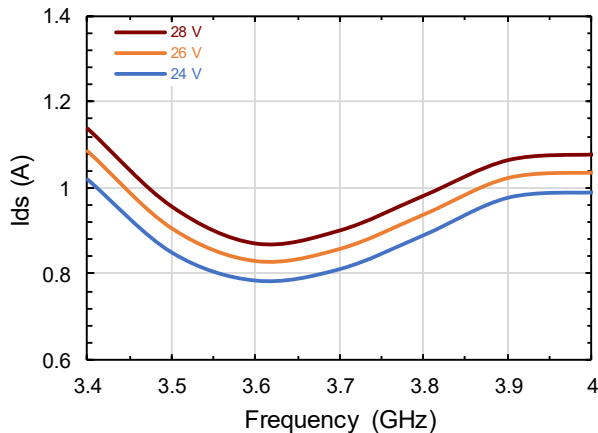

Gate Current vs. V_{DS} and Frequency

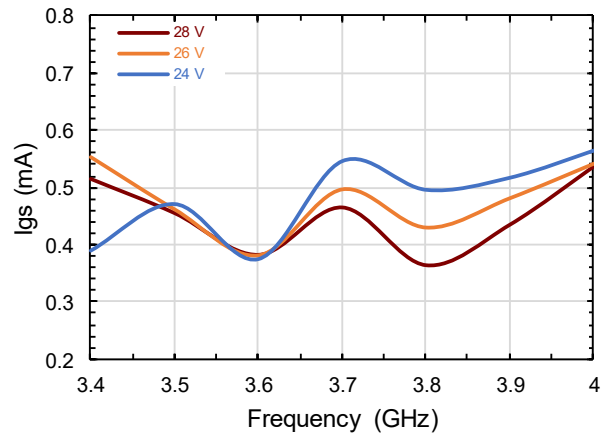

Large Signal Gain vs. V_{DS} and Frequency

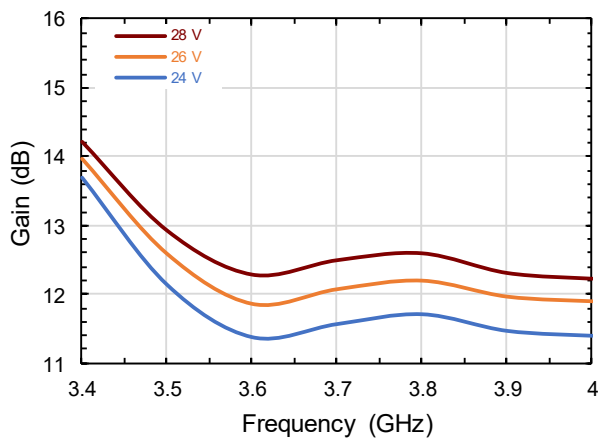

Typical Performance Curves as Measured in the 3.4 - 4.0 GHz Evaluation Test Fixture
 CW, P_{SAT} @ $I_{GS} = 0.36$ mA, $V_{DS} = 28$ V, $I_{DQ} = 100$ mA, Frequency = 3.7 GHz (Unless Otherwise Noted)
 For Engineering Evaluation Only – This data does not Modify MACOM's Datasheet Limits.

Output Power vs. I_{DQ} and Frequency

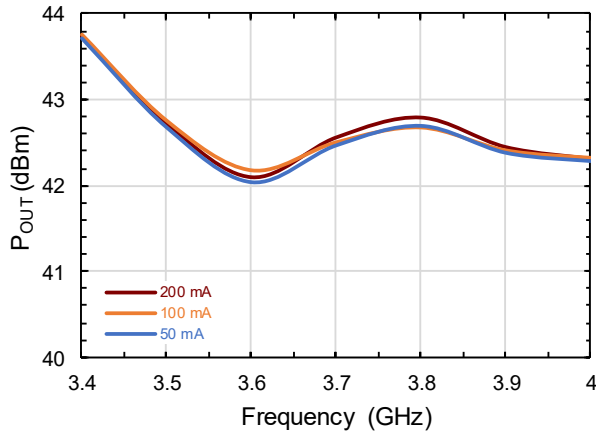

Drain Efficiency vs. I_{DQ} and Frequency

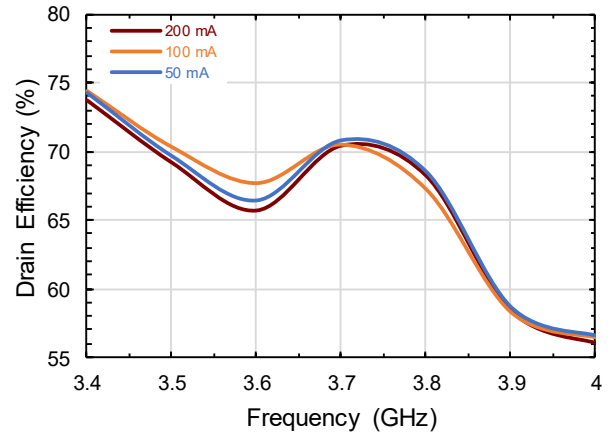

Drain Current vs. I_{DQ} and Frequency

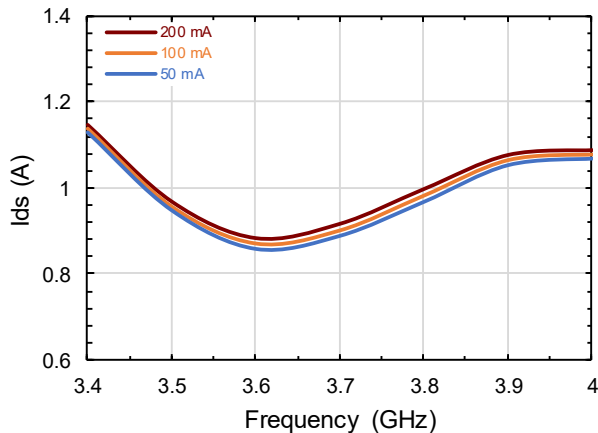

Gate Current vs. I_{DQ} and Frequency

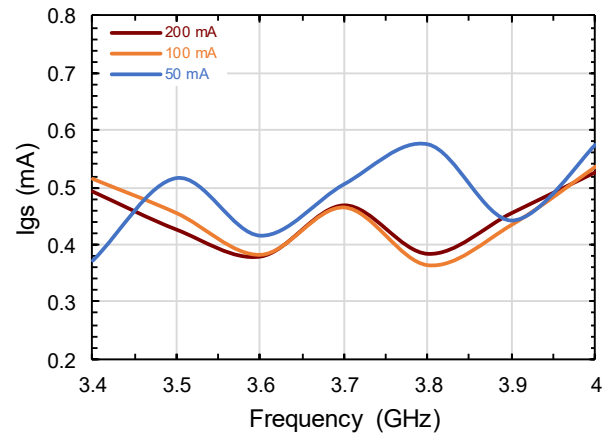

Large Signal Gain vs. I_{DQ} and Frequency

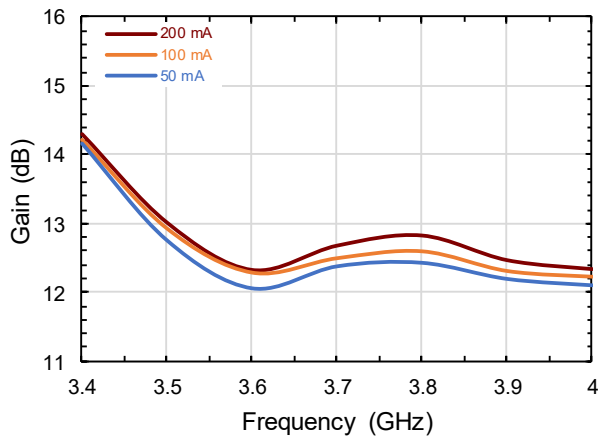

Typical Performance Curves as Measured in the 3.4 - 4.0 GHz Evaluation Test Fixture
 CW, P_{SAT} @ $I_{GS} = 0.36$ mA, $V_{DS} = 28$ V, $I_{DQ} = 100$ mA, Frequency = 3.7 GHz (Unless Otherwise Noted)
 For Engineering Evaluation Only – This data does not Modify MACOM's Datasheet Limits.

Output Power vs. Frequency and P_{IN}

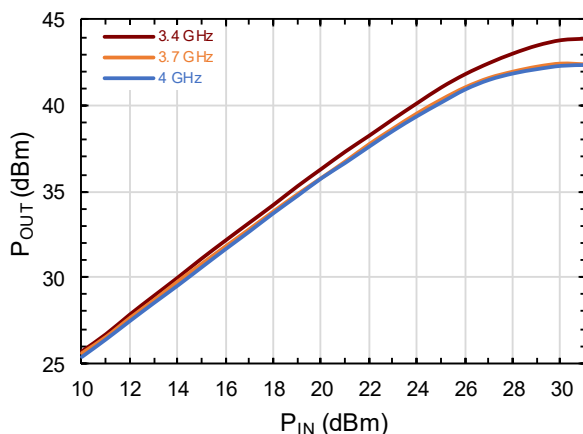

Drain Efficiency vs. Frequency and P_{IN}

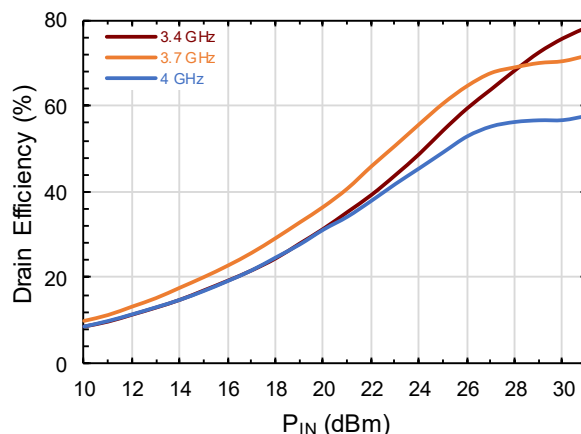

Drain Current vs. Frequency and P_{IN}

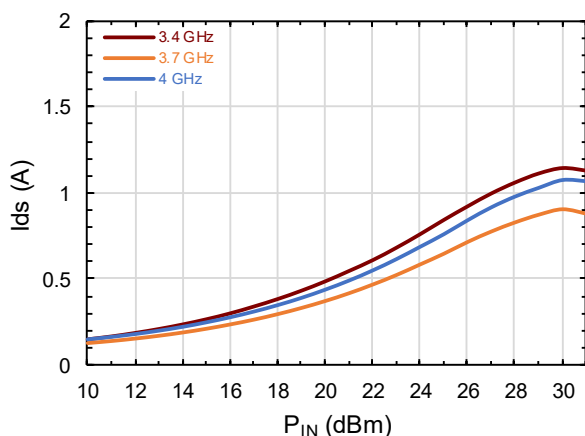

Gate Current vs. Frequency and P_{IN}

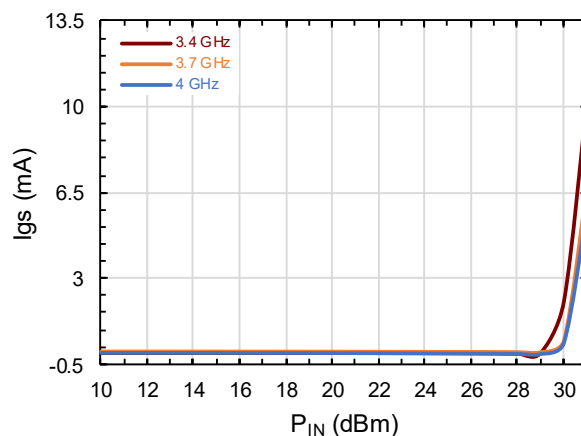

Large Signal Gain vs. Frequency and P_{IN}

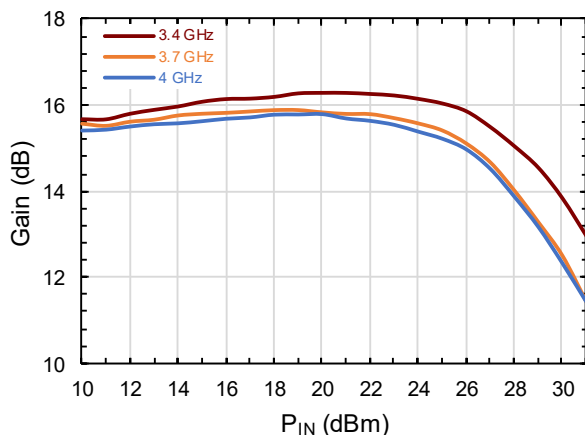

Typical Performance Curves as Measured in the 3.4 - 4.0 GHz Evaluation Test Fixture
 CW, P_{SAT} @ $I_{GS} = 0.36$ mA, $V_{DS} = 28$ V, $I_{DQ} = 100$ mA, Frequency = 3.7 GHz (Unless Otherwise Noted)
 For Engineering Evaluation Only – This data does not Modify MACOM's Datasheet Limits.

Output Power vs. Temperature and P_{IN}

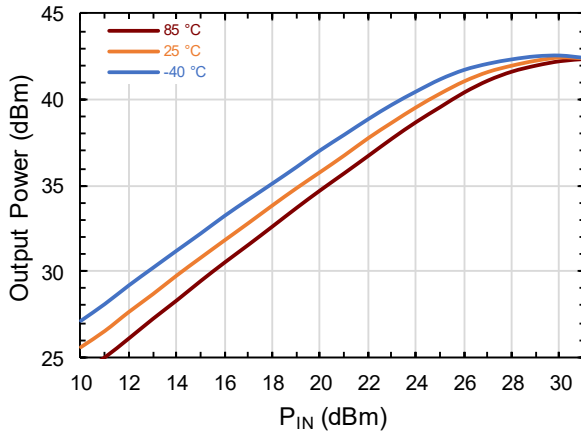

Drain Efficiency vs. Temperature and P_{IN}

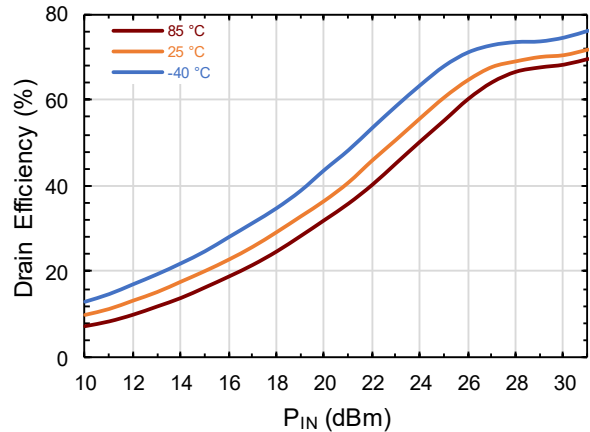

Drain Current vs. Temperature and P_{IN}

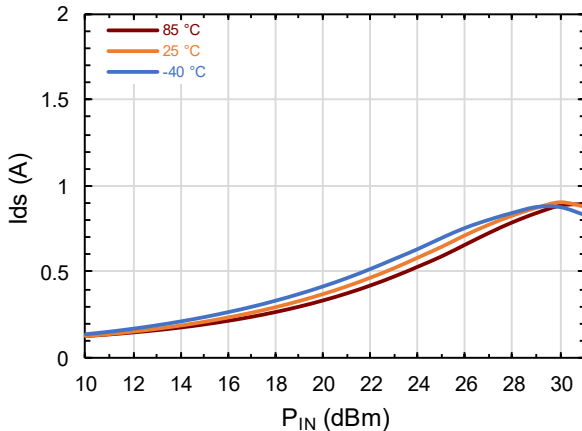

Gate Current vs. Temperature and P_{IN}

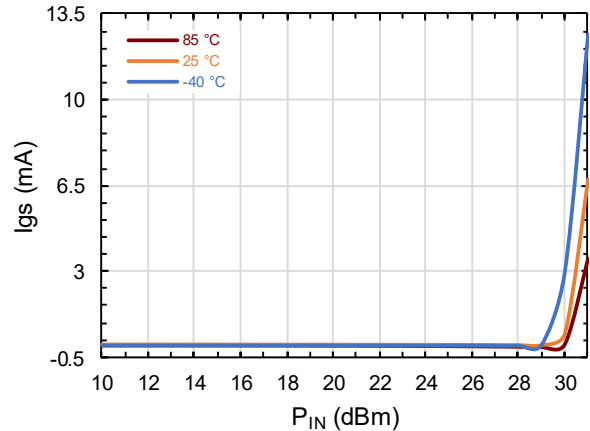

Large Signal Gain vs. Temperature and P_{IN}

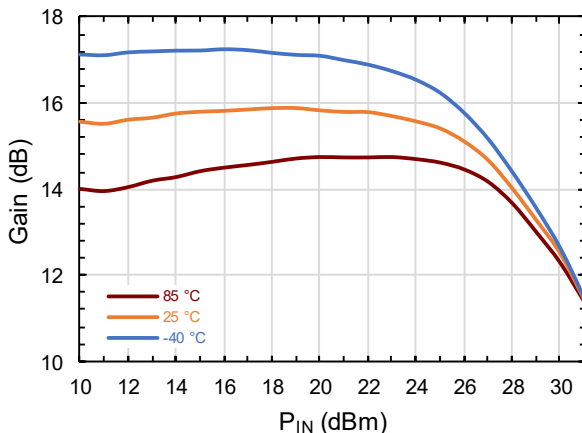

Typical Performance Curves as Measured in the 3.4 - 4.0 GHz Evaluation Test Fixture
 CW, P_{SAT} @ $I_{GS} = 0.36$ mA, $V_{DS} = 28$ V, $I_{DQ} = 100$ mA, Frequency = 3.7 GHz (Unless Otherwise Noted)
 For Engineering Evaluation Only – This data does not Modify MACOM's Datasheet Limits.

Output Power vs. V_{DS} and P_{IN}

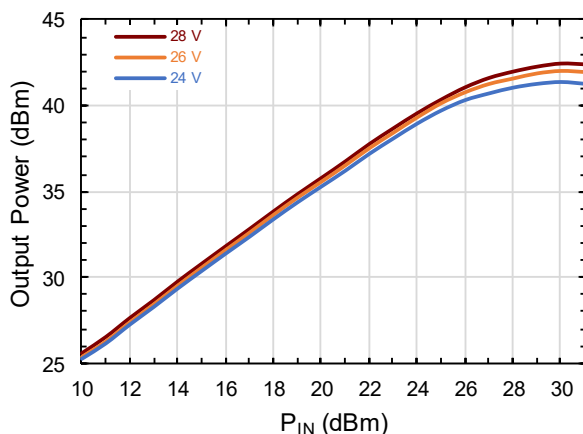

Drain Efficiency vs. V_{DS} and P_{IN}

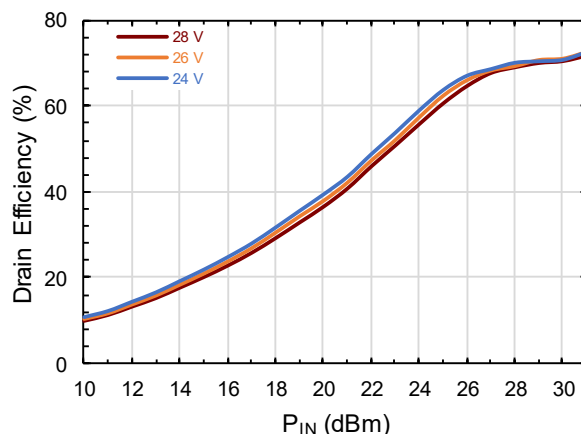

Drain Current vs. V_{DS} and P_{IN}

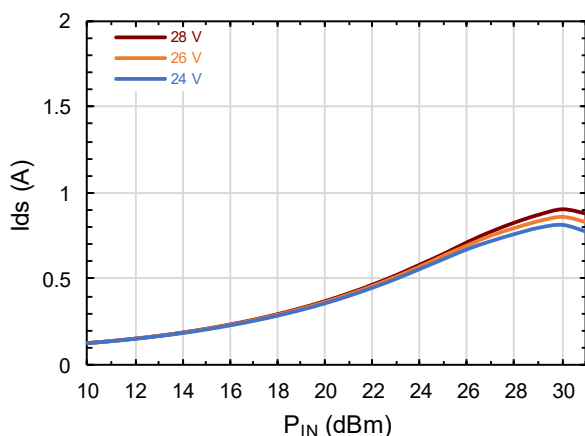

Gate Current vs. V_{DS} and P_{IN}

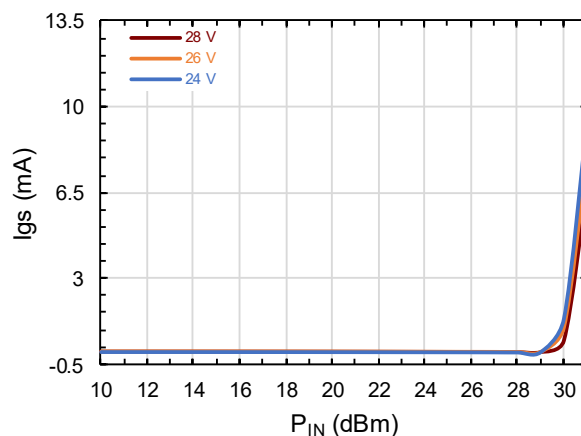

Large Signal Gain vs. V_{DS} and P_{IN}

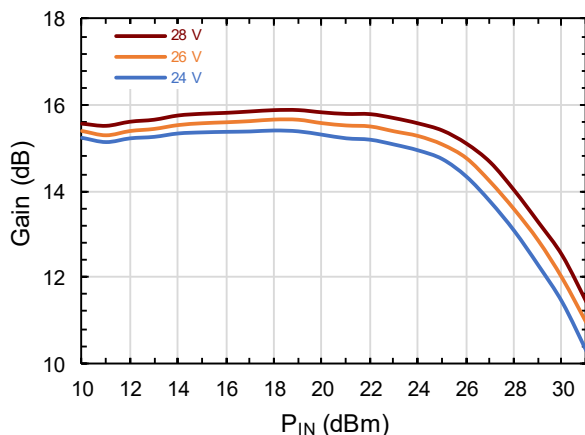

Typical Performance Curves as Measured in the 3.4 - 4.0 GHz Evaluation Test Fixture

CW, P_{SAT} @ $I_{GS} = 0.36$ mA, $V_{DS} = 28$ V, $I_{DQ} = 100$ mA, Frequency = 3.7 GHz (Unless Otherwise Noted)

For Engineering Evaluation Only – This data does not Modify MACOM's Datasheet Limits.

Output Power vs. I_{DQ} and P_{IN}

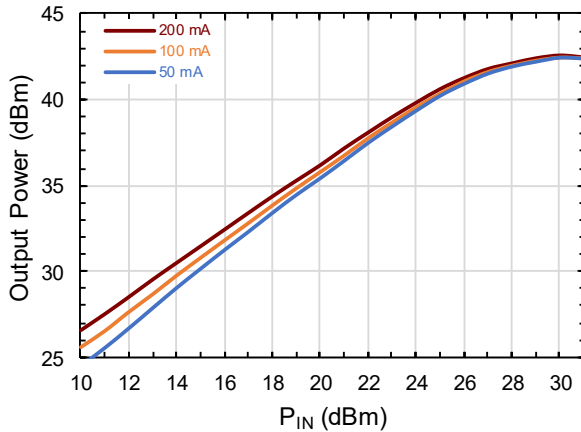

Drain Efficiency vs. I_{DQ} and P_{IN}

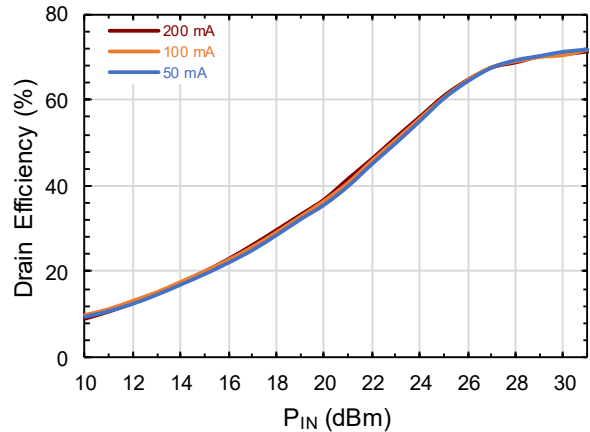

Drain Current vs. I_{DQ} and P_{IN}

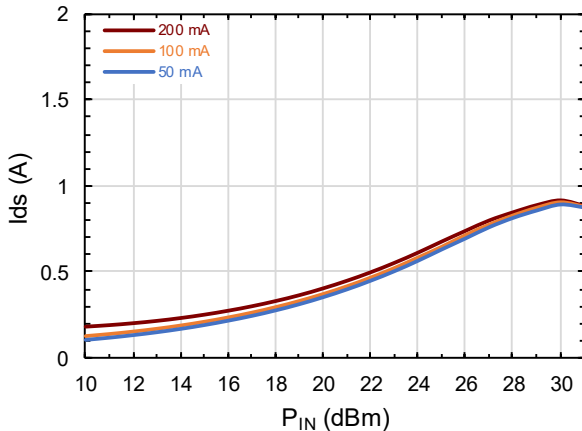

Gate Current vs. I_{DQ} and P_{IN}

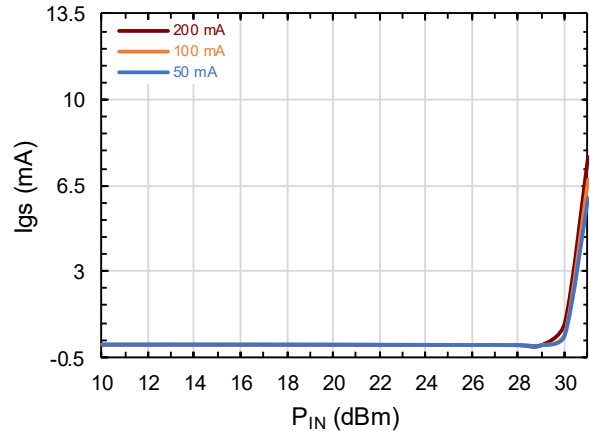

Large Signal Gain vs. I_{DQ} and P_{IN}

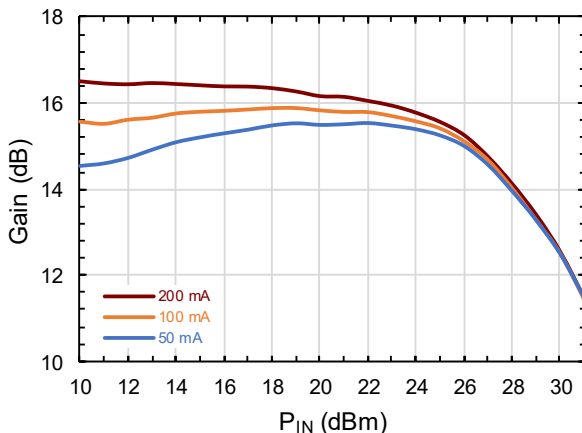

Typical Performance Curves as Measured in the 3.4 - 4.0 GHz Evaluation Test Fixture:

CW, $V_{DS} = 28\text{ V}$, $I_{DQ} = 100\text{ mA}$, $P_{IN} = -20\text{ dBm}$ (Unless Otherwise Noted)

For Engineering Evaluation Only—This data does not Modify MACOM's Datasheet Limits.

S21 vs Frequency and Temperature

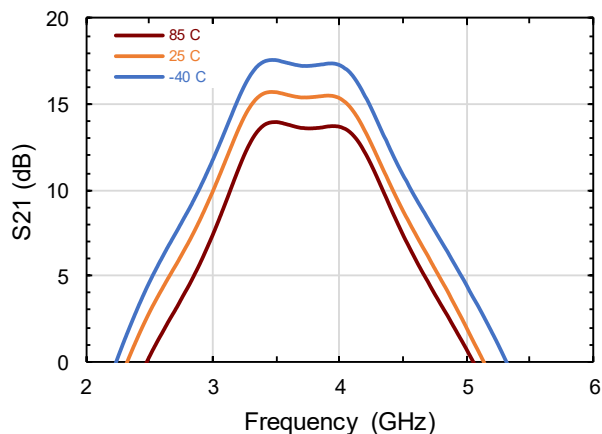

S21 vs Frequency and V_{DS}

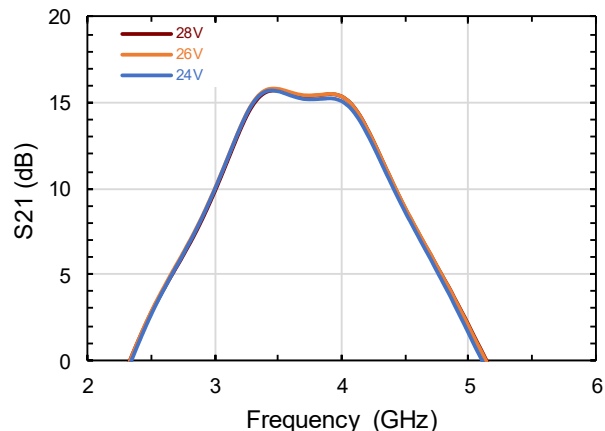

S11 vs Frequency and Temperature

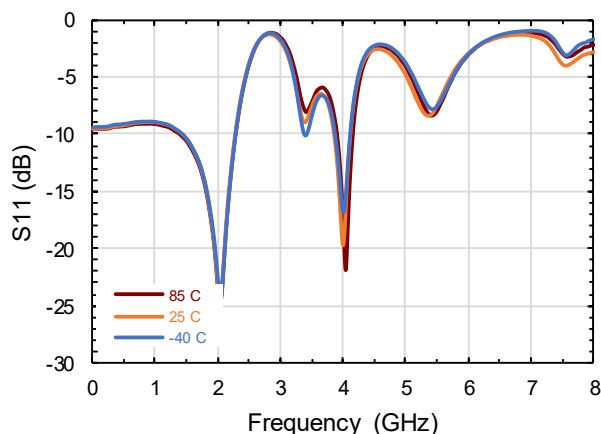

S11 vs Frequency and V_{DS}

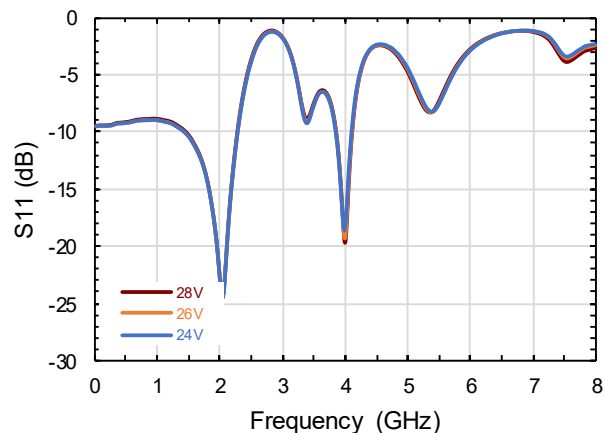

S22 vs Frequency and Temperature

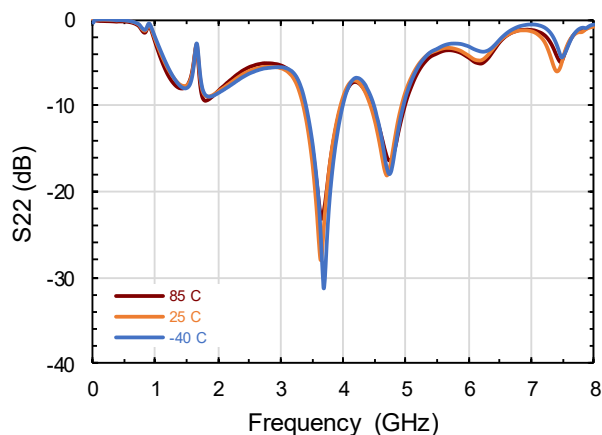

S22 vs Frequency and V_{DS}

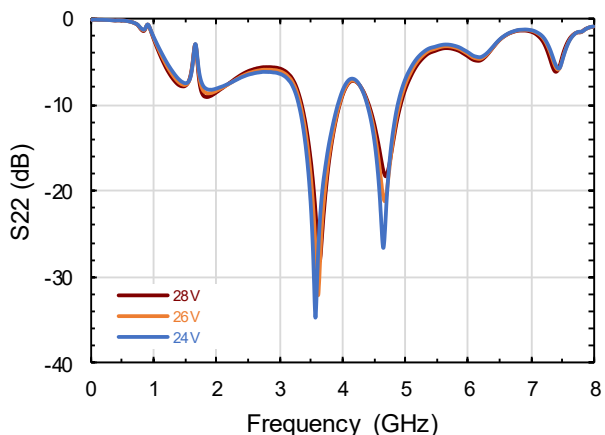

Typical Performance Curves as Measured in the 3.4 - 4.0 GHz Evaluation Test Fixture:

CW, $V_{DS} = 28\text{ V}$, $I_{DQ} = 100\text{ mA}$, $P_{IN} = -20\text{ dBm}$ (Unless Otherwise Noted)

For Engineering Evaluation Only—This data does not Modify MACOM's Datasheet Limits.

S21 vs Frequency and I_{DQ}

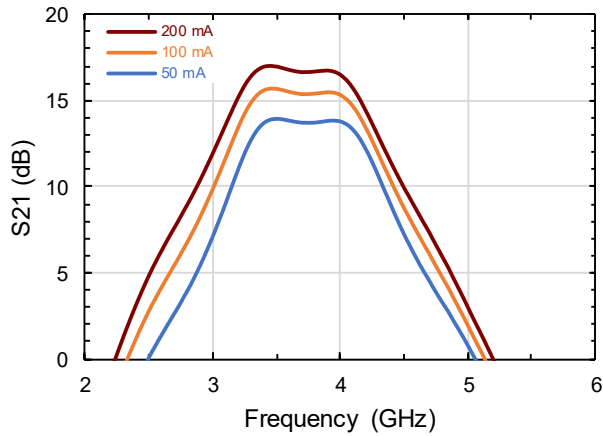

S11 vs Frequency and I_{DQ}

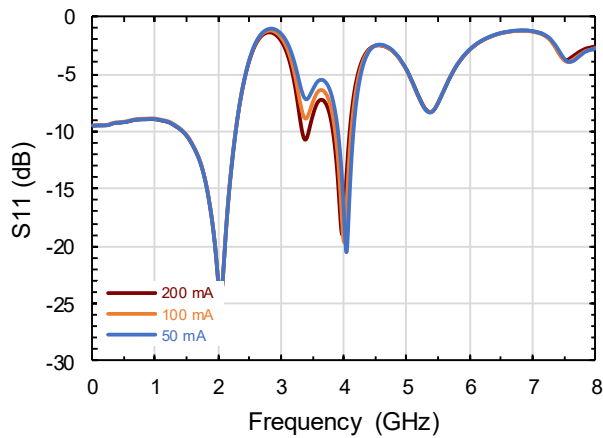

S22 vs Frequency and I_{DQ}

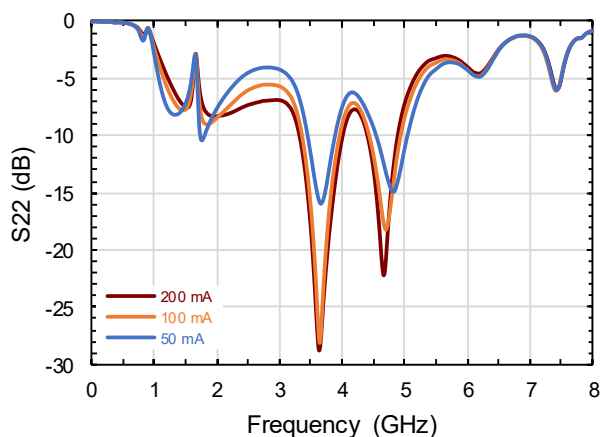

Lead-free 440196 Package Dimensions

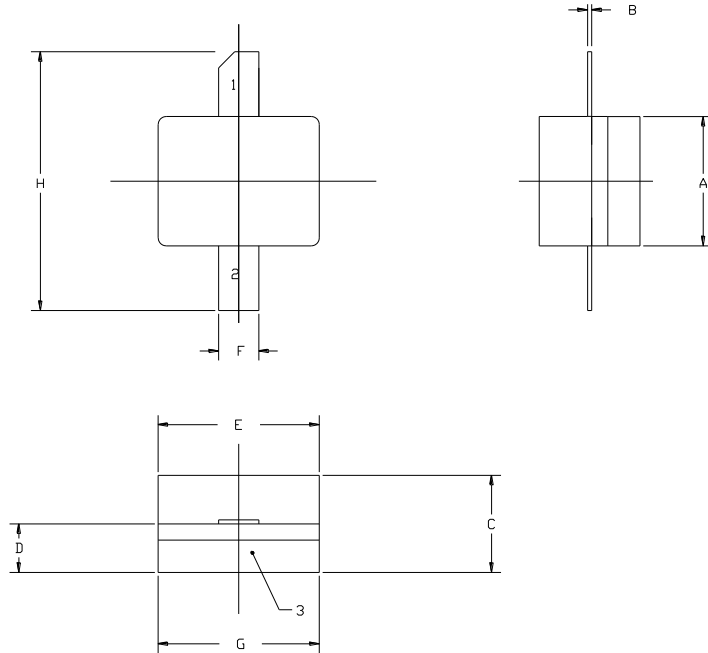

NOTES:

1. DIMENSIONING AND TOLERANCING PER ANSI Y14.5M, 1982.
2. CONTROLLING DIMENSION: INCH.
3. ADHESIVE FROM LID MAY EXTEND A MAXIMUM OF 0.020" BEYOND EDGE OF LID.
4. LID MAY BE MISALIGNED TO THE BODY OF THE PACKAGE BY A MAXIMUM OF 0.008" IN ANY DIRECTION.
5. ALL PLATED SURFACES ARE NI/AU

DIM	INCHES		MILLIMETERS	
	MIN	MAX	MIN	MAX
A	0.155	0.165	3.94	4.19
B	0.003	0.006	0.10	0.15
C	0.115	0.135	2.92	3.17
D	0.057	0.067	1.45	1.70
E	0.195	0.205	4.95	5.21
F	0.045	0.055	1.14	1.40
G	0.195	0.205	4.95	5.21
H	0.280	0.360	7.11	9.14

- PIN 1. GATE
PIN 2. DRAIN
PIN 3. SOURCE

Lead-free 440166 Package Dimensions

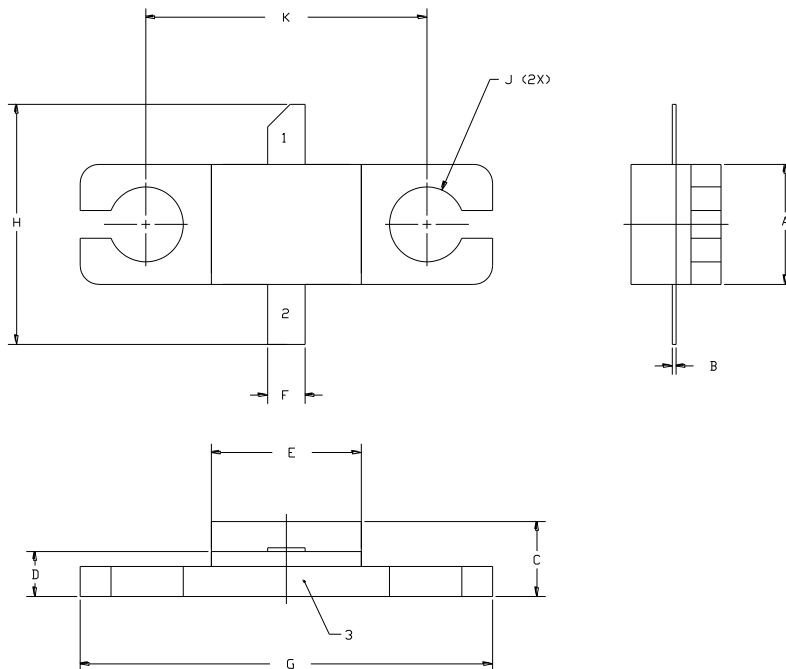

NOTES:

1. DIMENSIONING AND TOLERANCING PER ANSI Y14.5M, 1982.
2. CONTROLLING DIMENSION: INCH.
3. ADHESIVE FROM LID MAY EXTEND A MAXIMUM OF 0.020" BEYOND EDGE OF LID.
4. LID MAY BE MISALIGNED TO THE BODY OF THE PACKAGE BY A MAXIMUM OF 0.008" IN ANY DIRECTION.
5. ALL PLATED SURFACES ARE NI/AU

DIM	INCHES		MILLIMETERS	
	MIN	MAX	MIN	MAX
A	0.155	0.165	3.94	4.19
B	0.004	0.006	0.10	0.15
C	0.115	0.135	2.92	3.43
D	0.057	0.067	1.45	1.70
E	0.195	0.205	4.95	5.21
F	0.045	0.055	1.14	1.40
G	0.545	0.555	13.84	14.09
H	0.280	0.360	7.11	9.14
J	∅ .100		2.54	
K	0.375		9.53	

- PIN 1. GATE
PIN 2. DRAIN
PIN 3. SOURCE

MACOM Technology Solutions Inc. ("MACOM"). All rights reserved.

These materials are provided in connection with MACOM's products as a service to its customers and may be used for informational purposes only. Except as provided in its Terms and Conditions of Sale or any separate agreement, MACOM assumes no liability or responsibility whatsoever, including for (i) errors or omissions in these materials; (ii) failure to update these materials; or (iii) conflicts or incompatibilities arising from future changes to specifications and product descriptions, which MACOM may make at any time, without notice. These materials grant no license, express or implied, to any intellectual property rights.

THESE MATERIALS ARE PROVIDED "AS IS" WITH NO WARRANTY OR LIABILITY, EXPRESS OR IMPLIED, RELATING TO SALE AND/OR USE OF MACOM PRODUCTS INCLUDING FITNESS FOR A PARTICULAR PURPOSE, MERCHANTABILITY, INFRINGEMENT OF INTELLECTUAL PROPERTY RIGHT, ACCURACY OR COMPLETENESS, OR SPECIAL, INDIRECT, INCIDENTAL, OR CONSEQUENTIAL DAMAGES WHICH MAY RESULT FROM USE OF THESE MATERIALS.

MACOM products are not intended for use in medical, lifesaving or life sustaining applications. MACOM customers using or selling MACOM products for use in such applications do so at their own risk and agree to fully indemnify MACOM for any damages resulting from such improper use or sale.