

## Features

- Saturated Power: 8 W
- Drain Efficiency: 69%
- Small Signal Gain: 19 dB
- DFN 3 x 4, 12 L Plastic Package
- RoHS\* Compliant

## Applications

- Avionics - TACAN, DME, IFF
- Military Radio
- L, S, C-band Radar
- Electronic Warfare
- ISM
- General Amplification

## Description

The MAPC-A3005-AD is a 8 W packaged, unmatched transistor utilizing a high performance, GaN on SiC production process. This transistor supports both defense and commercial related applications.

Offered in a thermally-enhanced flange package, the MAPC-A3005-AD provides superior performance under CW operation allowing customers to improve SWaP-C benchmarks in their next generation systems.

## Typical RF Performance:

- Measured at CW @  $P_{SAT}$  defined at  $P_{IN} = 30$  dBm.  
 $V_{DS} = 28$  V,  $I_{DQ} = 100$  mA,  $T_C = 25^\circ\text{C}$

Frequency (GHz)	Output Power (dBm)	Gain (dB)	$\eta_D$ (%)
2	40.0	10.0	65.7
4	39.4	9.4	48.3
6	39.9	9.9	45.3



3x4 mm PDFN-12LD

## Functional Schematic

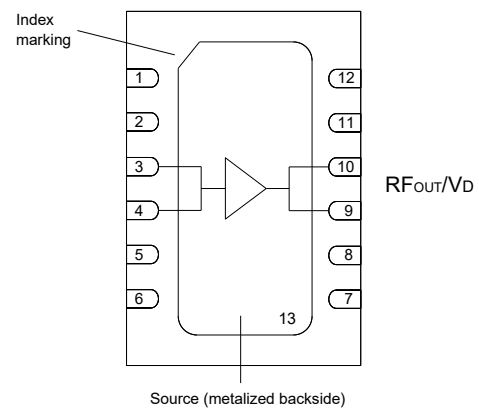

## Pin Configuration

Pin #	Pin Function	Function
3,4	RF <sub>IN</sub> / V <sub>G</sub>	RF Input / Gate
9,10	RF <sub>OUT</sub> / V <sub>D</sub>	RF Output / Drain
1,2,5,6,7,8,11,12,13	Flange <sup>1</sup>	Ground / Source

1. The flange on the package bottom must be connected to RF, DC and thermal ground.

## Ordering Information

Part Number	MOQ Increment
MAPC-A3005-AD000	Bulk
MAPC-A3005-ADTR1	Tape and Reel
MAPC-A3005-ADSB1	Sample Board

\* Restrictions on Hazardous Substances, compliant to current RoHS EU directive.

**RF Electrical Specifications<sup>2</sup>: Freq. = 2 GHz, T<sub>A</sub> = +25°C, V<sub>DS</sub> = 28 V, I<sub>DQ</sub> = 100 mA**

Parameter	Conditions	Symbol	Min.	Typ.	Max.	Units
Saturated Power	P <sub>IN</sub> = 25 dBm, CW	P <sub>SAT</sub>	7.0	8.4	12.5	W
Drain Efficiency	P <sub>IN</sub> = 25 dBm, CW	η <sub>SAT</sub>	64.0	68.4	90.0	%
Low Power Gain	P <sub>IN</sub> = 10 dBm, CW	G <sub>SS</sub>	12.0	18.9	23.0	dB

2. Final testing and screening for all transistor sales is performed using the MAPC-A3005-AD-AMP at 2 GHz.

**Absolute Maximum Ratings<sup>3,4</sup>**

Parameter	Absolute Maximum
Drain-Source Voltage	84 V
Gate Voltage	-10, +2 V
Drain Current	1.4 A
Gate Current	2.1 mA
Storage Temperature	-55°C to +150°C
Mounting Temperature	+245°C
Junction Temperature <sup>5,6</sup>	+225°C
Operating Temperature	-40°C to +85°C

3. Exceeding any one or combination of these limits may cause permanent damage to this device.
4. MACOM does not recommend sustained operation near these survivability limits.
5. Operating at nominal conditions with T<sub>J</sub> ≤ +225 °C will ensure MTTF > 1 x 10<sup>6</sup> hours.
6. Junction Temperature (T<sub>J</sub>) = T<sub>C</sub> + Θ<sub>Jc</sub> \* (V \* I)  
Typical thermal resistance (Θ<sub>Jc</sub>) = 10.1 °C/W for CW.
  - a) For T<sub>C</sub> = +25°C,  
T<sub>J</sub> = 89 °C @ P<sub>DISS</sub> = 6.29 W
  - b) For T<sub>C</sub> = +85°C,  
T<sub>J</sub> = 148 °C @ P<sub>DISS</sub> = 6.28 W

**Handling Procedures**

Please observe the following precautions to avoid damage:

**Static Sensitivity**

These electronic devices are sensitive to electrostatic discharge (ESD) and can be damaged by static electricity. Proper ESD control techniques should be used when handling these HBM Class 1A and CDM Class C2B devices.

**Evaluation Test Fixture and Recommended Tuning Solution, 2 - 6 GHz**

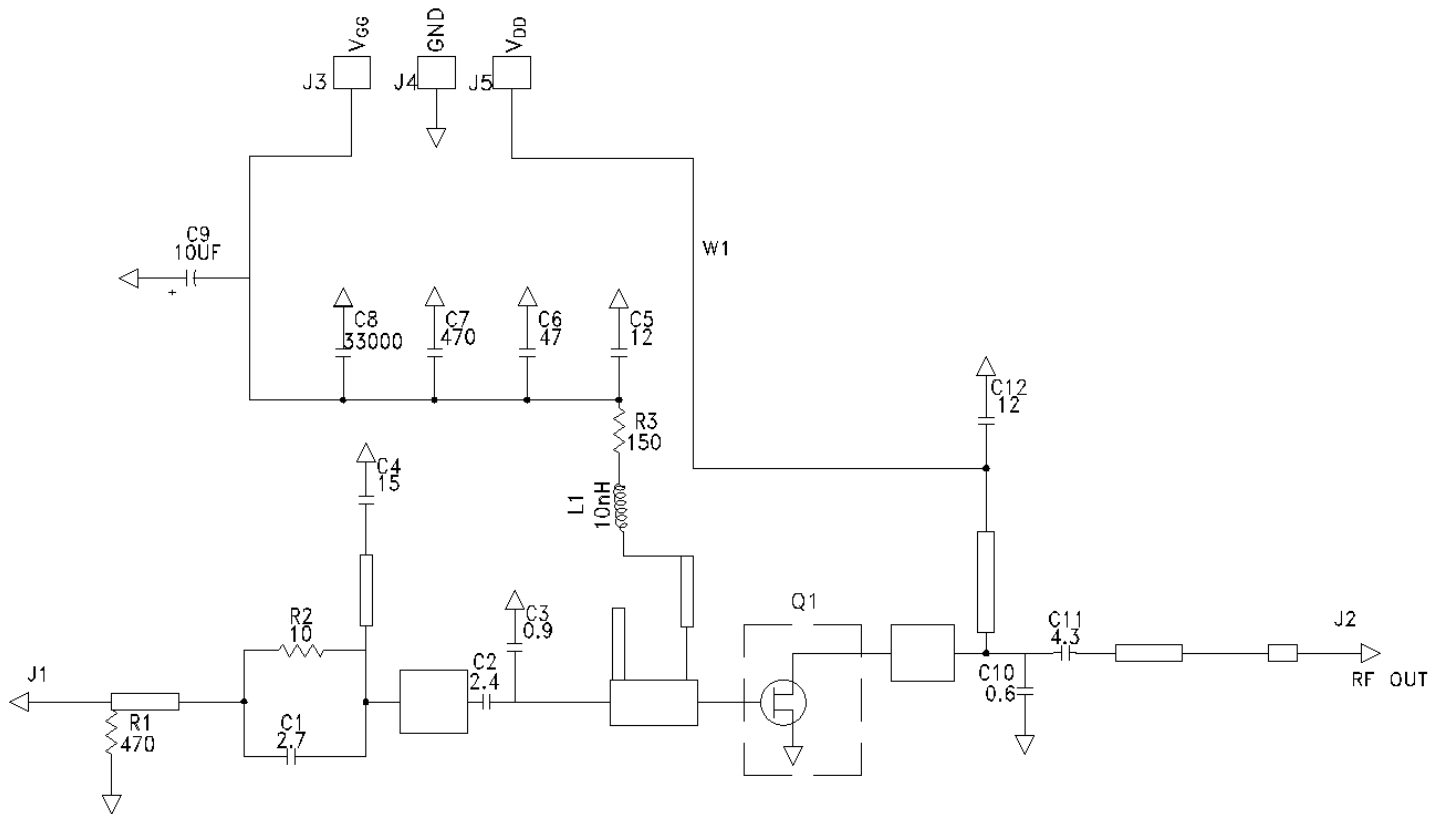

**Description**

Parts measured on evaluation board (20-mil thick RT/duroid 5880). Matching is provided using a combination of lumped elements and transmission lines as shown in the simplified schematic above. Recommended tuning solution component placement, transmission lines, and details are shown on the next page.

**Biasing Sequence**

**Bias ON**

1. Ensure RF is turned off
2. Apply pinch-off voltage of -5 V to the gate
3. Apply nominal drain voltage
4. Bias gate to desired quiescent drain current
5. Apply RF

**Bias OFF**

1. Turn RF off
2. Apply pinch-off voltage of -5 V to the gate
3. Turn-off drain voltage
4. Turn-off gate voltage

Evaluation Test Fixture and Recommended Tuning Solution, 2 - 6 GHz

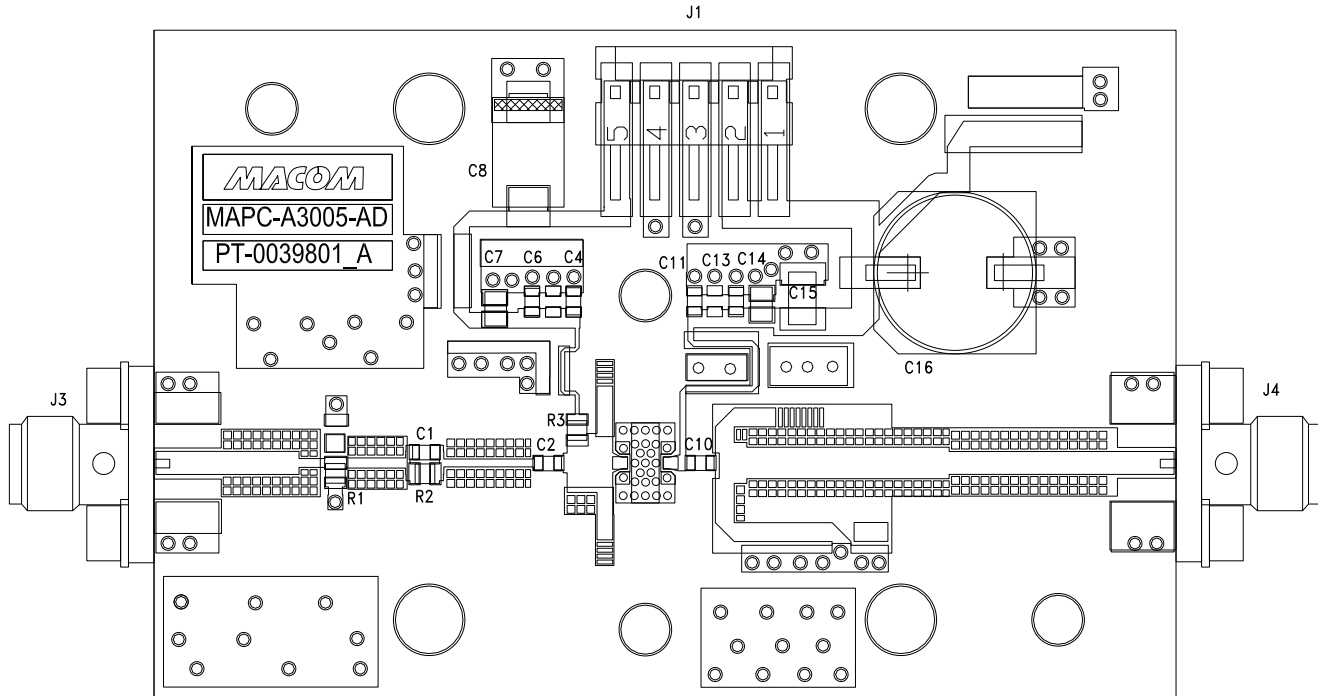

**Assembly Parts List**

Reference Designator	Description	Qty.
C1	CAP 1.3pF 0603in T0.1p 125C 250V, ATC600S	1
C2	CAP 2.7pF 0603in T0.1p 125C 250V ATC600S	1
C4,C11	CAP 8.2pF 0603in T0.1p 125C 250V ATC600S	2
C10	CAP 3.6pF 0603in T0.1p 125C 250V ATC600S	1
C6,C13	CAP 470pF 0603in T5% X7R 100V AVX	2
C7,C14	CAP 33000pF 0805 X7R 100V	2
C8	CAP 10UF 2312 16V TANTALUM	1
C16	CAP CAP, 33 UF, 20%, G CASE	1
C15	CAP 1.0UF 1210 T10% X7R 100V	1
R1	RES, AIN, 470 OHM, +/- 5%, 0505, PtAg TERMINATION	1
R2	RES, AIN, 50.0 OHM, +/- 5%, 0505, PtAg TERMINATION	1
R3	RES, AIN, 360 OHM, +/- 5%, 0505, PtAg TERMINATION	1
J3,J4	CONN, SMA, PANEL MOUNT JACK, FLANGE, 4-HOLE, BLUNT POST, 20MIL	2
J1	HEADER RT>PLZ .1CEN LK 5POS	1
-	PCB, RO5880, 0.020" THK	1
Q1	MAPC-A3005-AD	1

### Typical Performance Curves as Measured in the 2 - 6 GHz Evaluation Test Fixture

For Engineering Evaluation Only – This data does not Modify MACOM's Datasheet Limits.

CW,  $P_{IN} = 30$  dBm,  $V_{DS} = 28$  V,  $I_{DQ} = 100$  mA

#### Output Power over Temperature

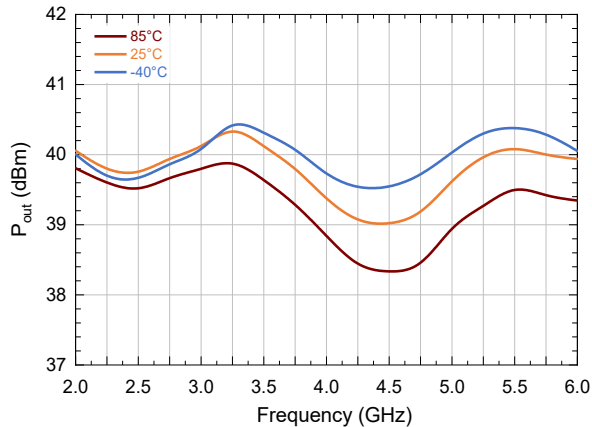

#### Drain Efficiency over Temperature

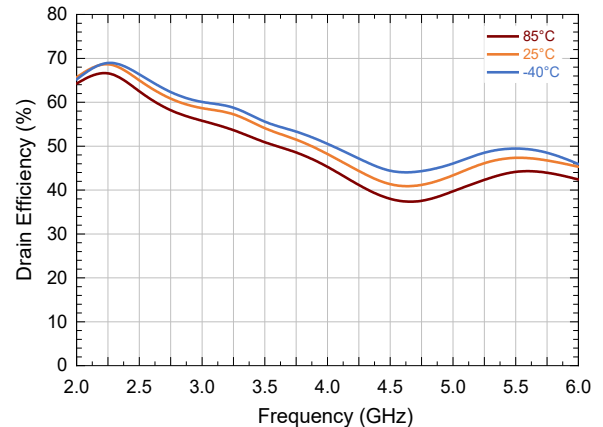

#### Drain Current over Temperature

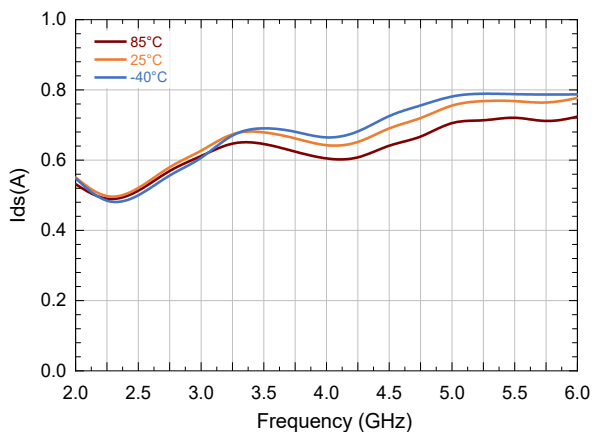

#### Gate Current over Temperature

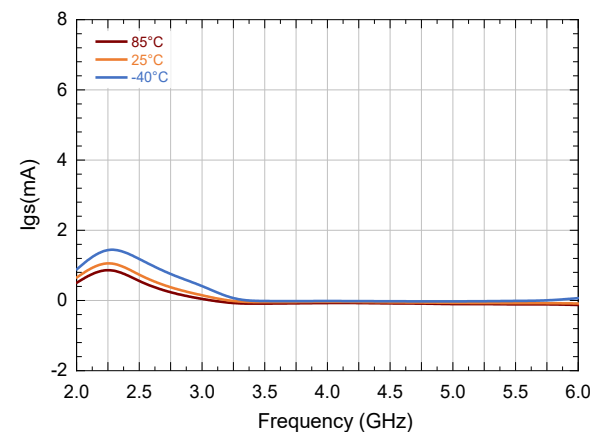

#### Large Signal Gain over Temperature

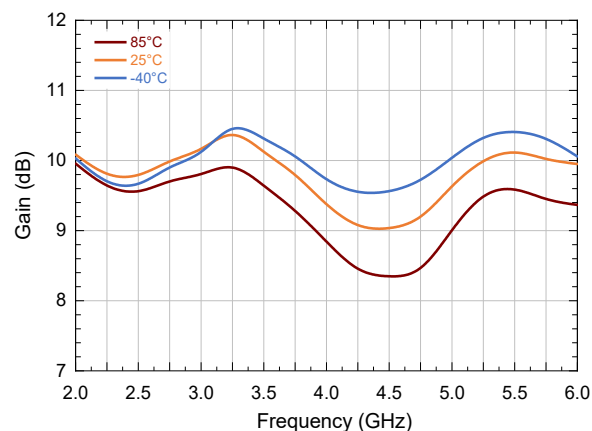

**Typical Performance Curves as Measured in the 2 - 6 GHz Evaluation Test Fixture**

For Engineering Evaluation Only – This data does not Modify MACOM's Datasheet Limits.

CW,  $P_{IN} = 30$  dBm,  $I_{DQ} = 100$  mA,  $T_C = 25^\circ\text{C}$

**Output Power over Voltage**

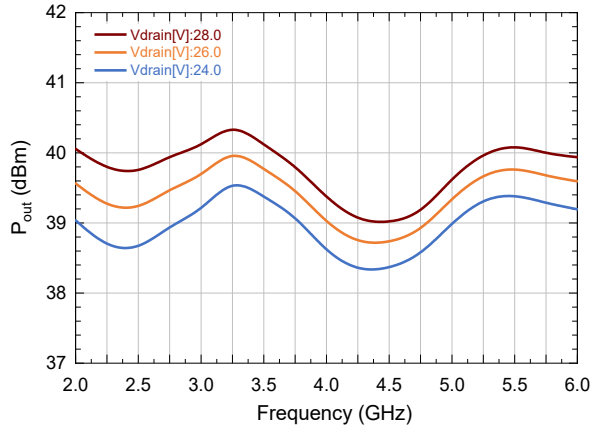

**Drain Efficiency over Voltage**

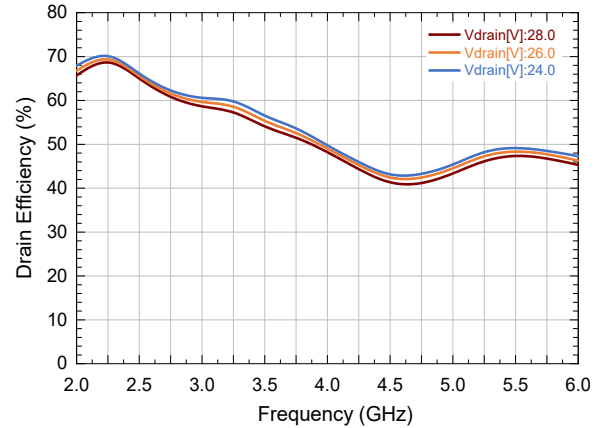

**Drain Current over Voltage**

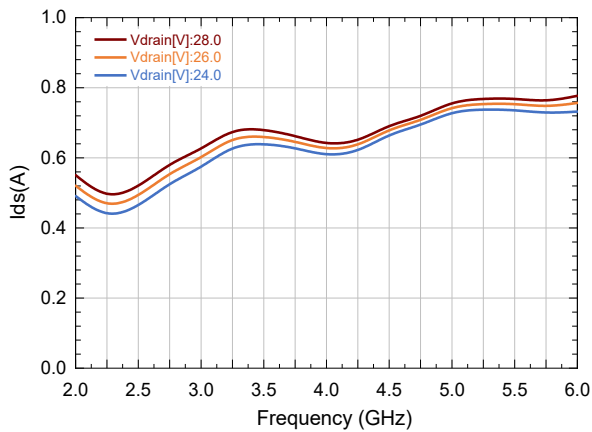

**Gate Current over Voltage**

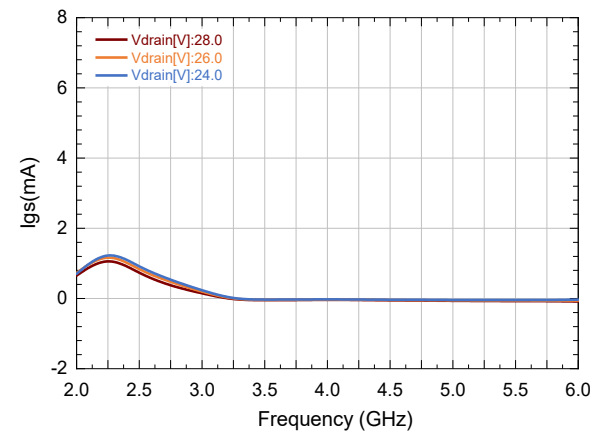

**Large Signal Gain over Voltage**

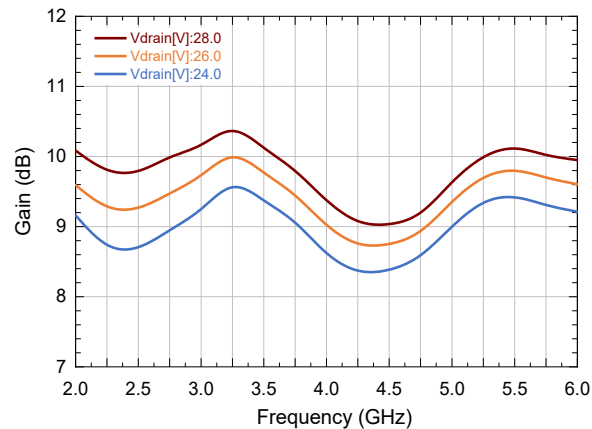

### Typical Performance Curves as Measured in the 2 - 6 GHz Evaluation Test Fixture

For Engineering Evaluation Only – This data does not Modify MACOM's Datasheet Limits.

CW,  $P_{IN} = 30$  dBm,  $V_{DS} = 28$  V,  $T_C = 25^\circ\text{C}$

#### Output Power over Quiescent Drain Current

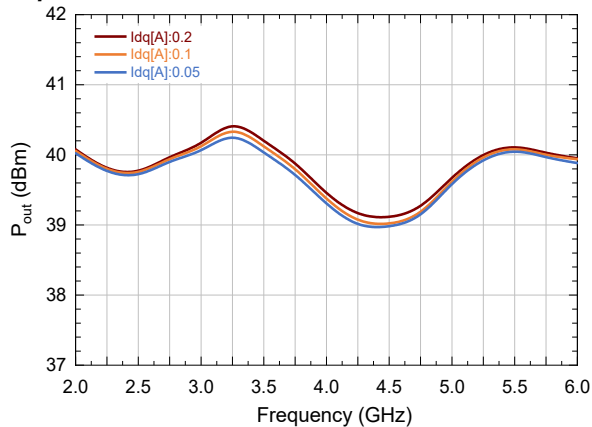

#### Drain Efficiency over Quiescent Drain Current

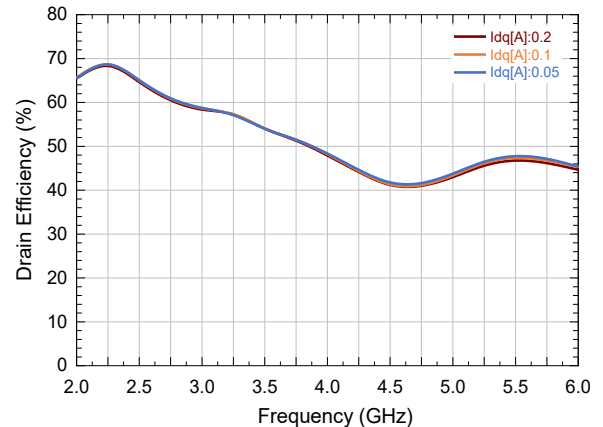

#### Drain Current over Quiescent Drain Current

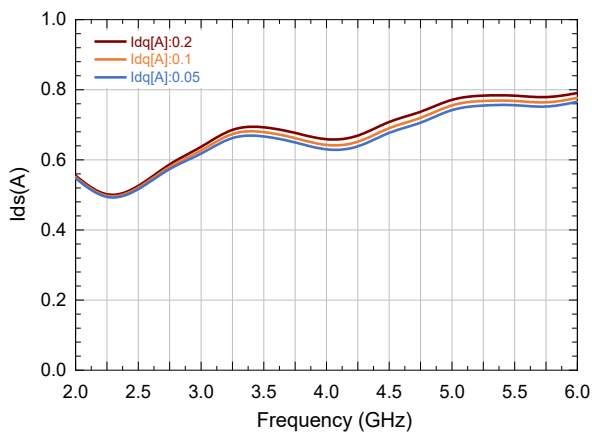

#### Gate Current over Quiescent Drain Current

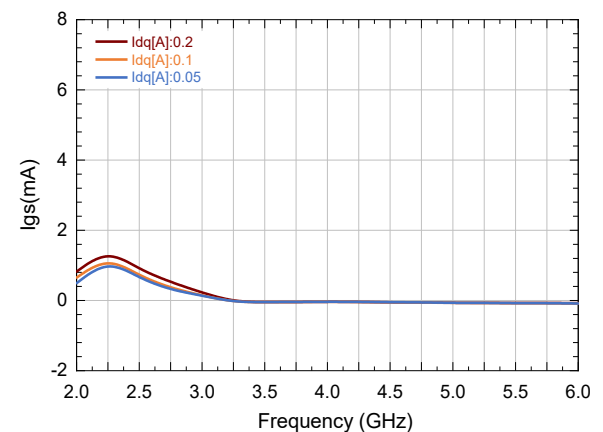

#### Large Signal Gain over Quiescent Drain Current

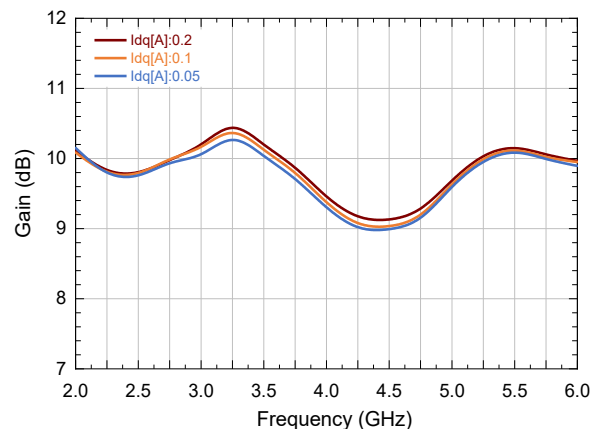

**Typical Performance Curves as Measured in the 2 - 6 GHz Evaluation Test Fixture**

For Engineering Evaluation Only – This data does not Modify MACOM’s Datasheet Limits.

CW,  $V_{DS} = 28\text{ V}$ ,  $I_{DQ} = 100\text{ mA}$ , Freq. = 2 GHz

**Output Power over Temperature vs.  $P_{IN}$**

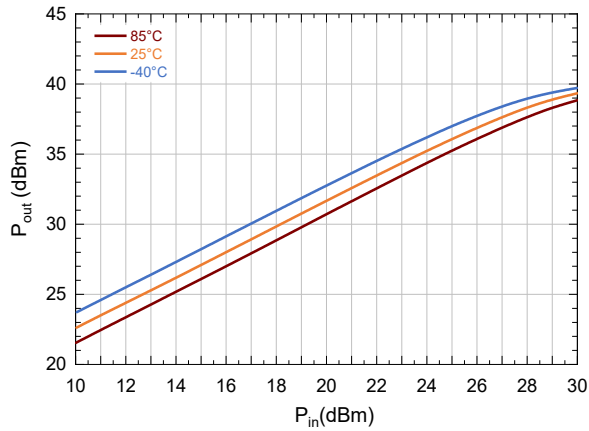

**Drain Efficiency over Temperature vs.  $P_{IN}$**

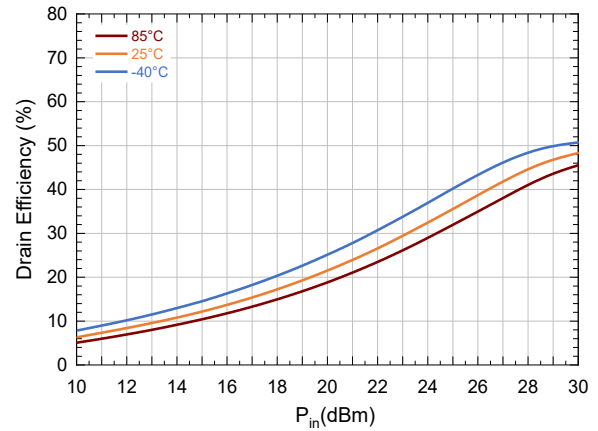

**Drain Current over Temperature vs.  $P_{IN}$**

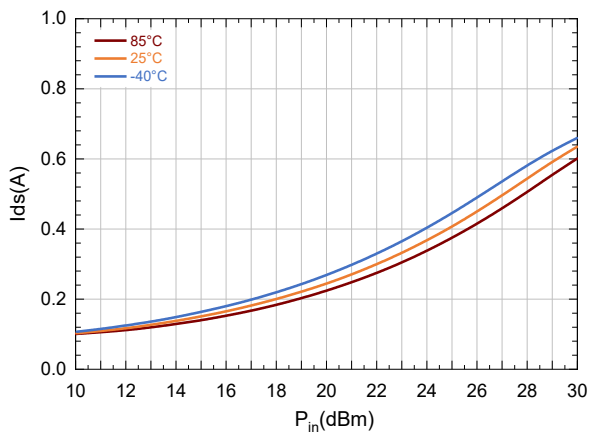

**Gate Current over Temperature vs.  $P_{IN}$**

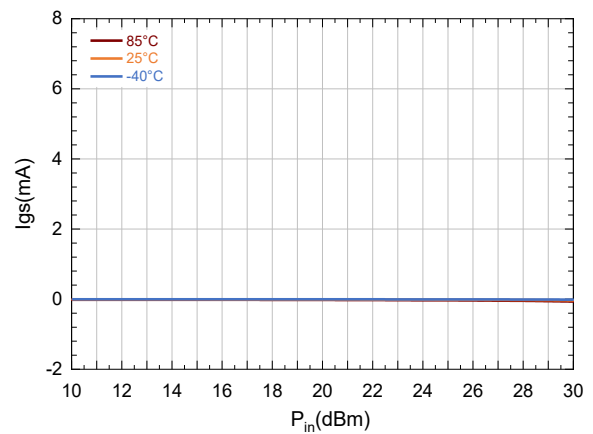

**Large Signal Gain over Temperature vs.  $P_{IN}$**

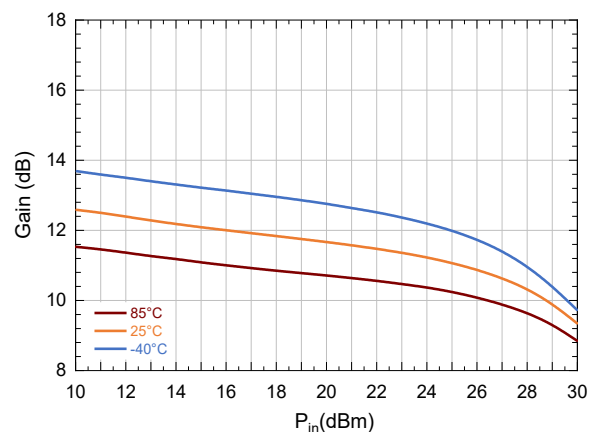



**Typical Performance Curves as Measured in the 2 - 6 GHz Evaluation Test Fixture**

For Engineering Evaluation Only – This data does not Modify MACOM’s Datasheet Limits.

CW,  $V_{DS} = 28\text{ V}$ ,  $I_{DQ} = 100\text{ mA}$ ,  $T_C = 25^\circ\text{C}$

**Output Power over Frequency vs.  $P_{IN}$**

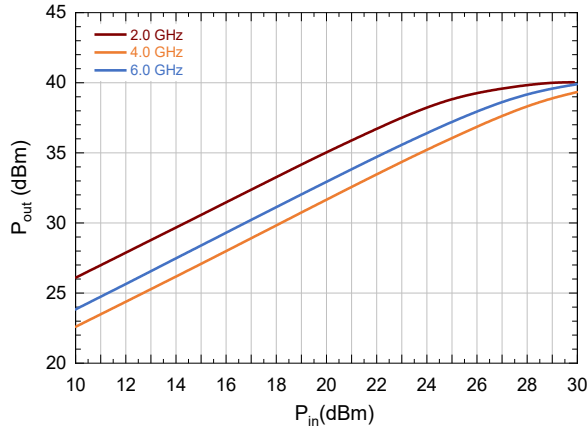

**Drain Efficiency over Frequency vs.  $P_{IN}$**

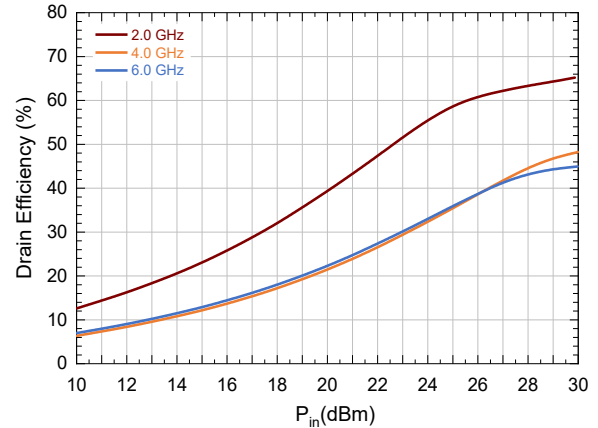

**Drain Current over Frequency vs.  $P_{IN}$**

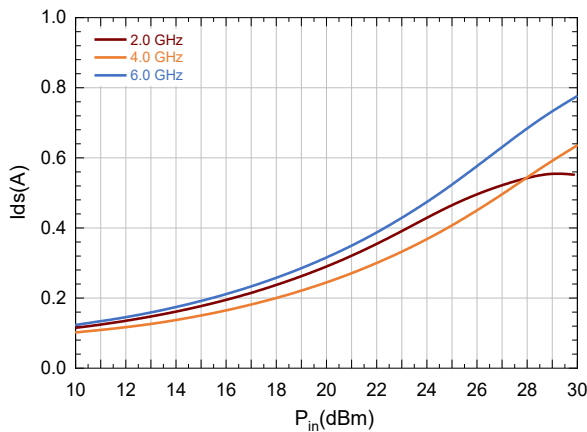

**Gate Current over Frequency vs.  $P_{IN}$**

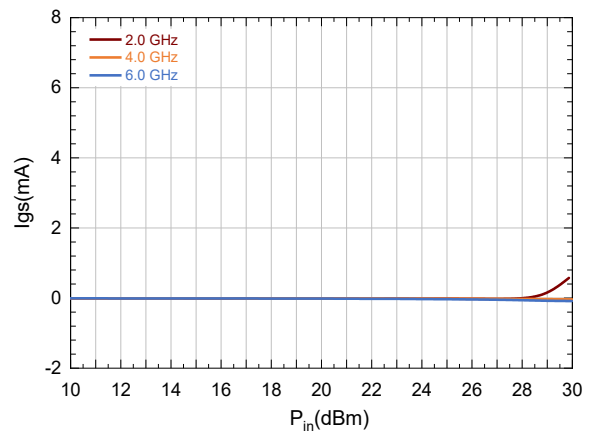

**Large Signal Gain over Frequency vs.  $P_{IN}$**

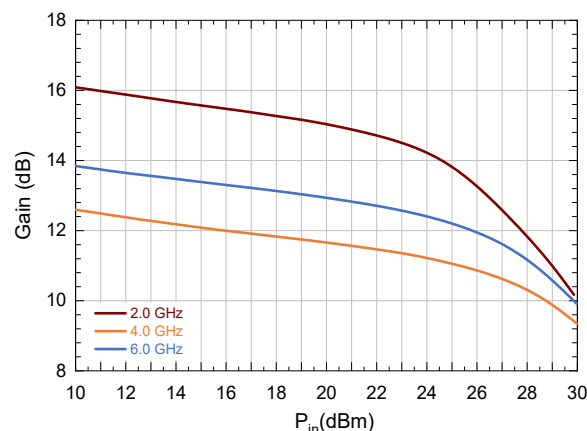

**Typical Performance Curves as Measured in the 2 - 6 GHz Evaluation Test Fixture**

For Engineering Evaluation Only – This data does not Modify MACOM’s Datasheet Limits.

CW,  $I_{DQ} = 100$  mA, Freq. = 2 GHz,  $T_C = 25^\circ$

**Output Power over Voltage vs.  $P_{IN}$**

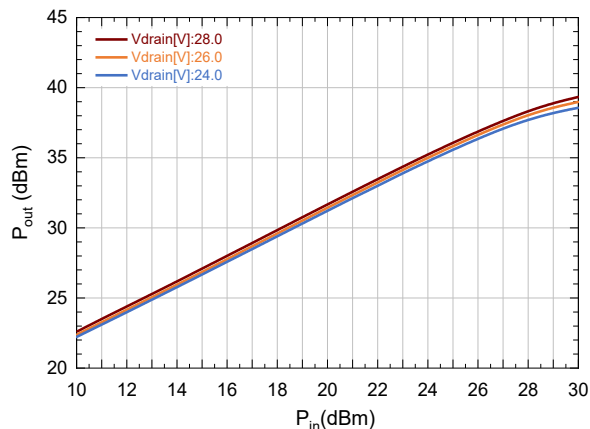

**Drain Efficiency over Voltage vs.  $P_{IN}$**

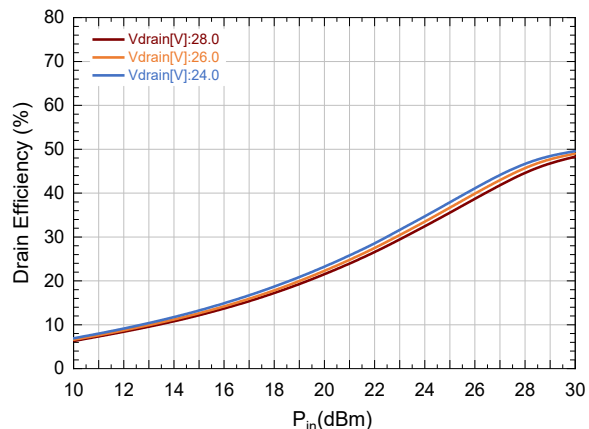

**Drain Current over Voltage vs.  $P_{IN}$**

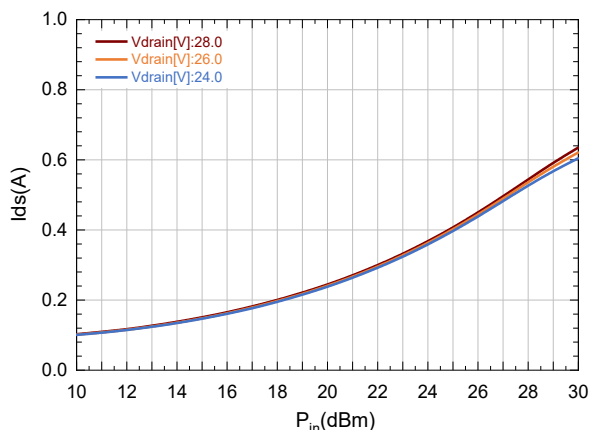

**Gate Current over Voltage vs.  $P_{IN}$**

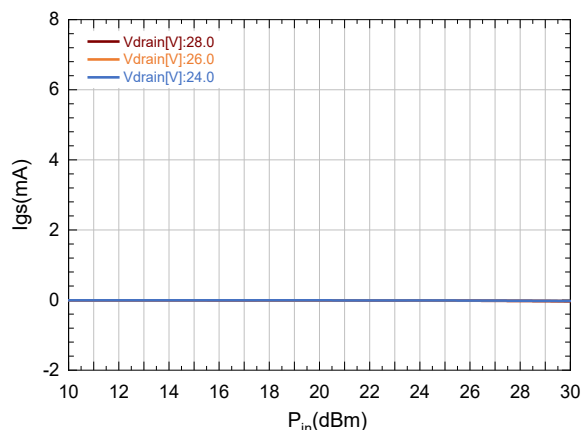

**Large Signal Gain over Voltage vs.  $P_{IN}$**

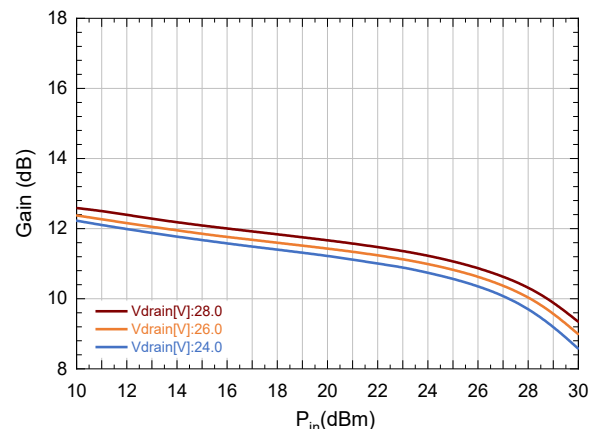

**Typical Performance Curves as Measured in the 2 - 6 GHz Evaluation Test Fixture**

For Engineering Evaluation Only – This data does not Modify MACOM’s Datasheet Limits.

CW,  $V_{DS} = 28$  V, Freq. = 2 GHz,  $T_C = 25^\circ$

**Output Power over Quiescent Drain Current vs.  $P_{IN}$**

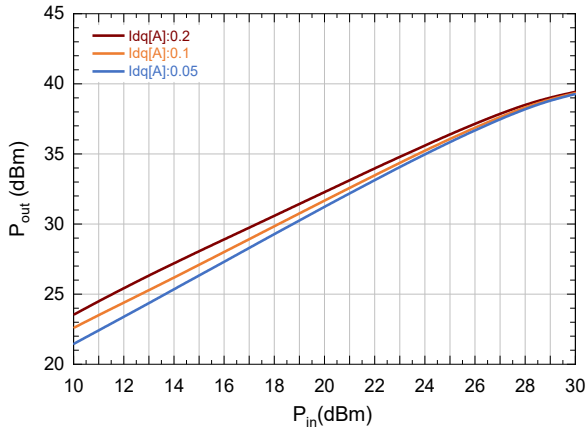

**Drain Efficiency over Quiescent Drain Current vs.  $P_{IN}$**

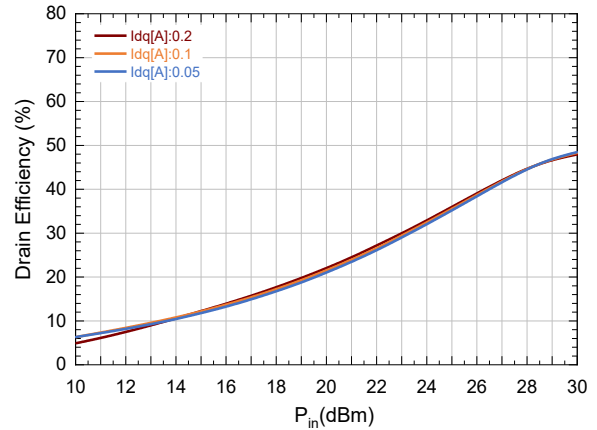

**Drain Current over Quiescent Drain Current vs.  $P_{IN}$**

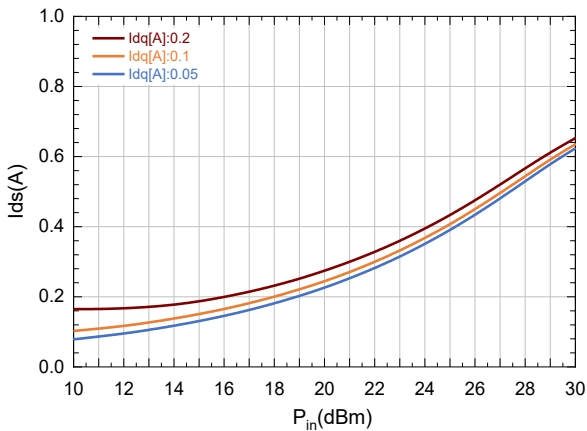

**Gate Current over Quiescent Drain Current vs.  $P_{IN}$**

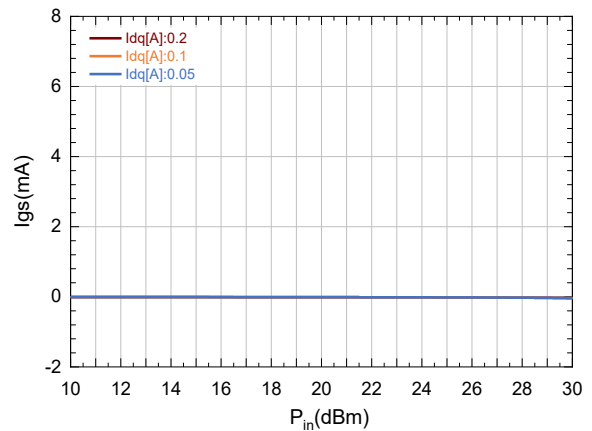

**Large Signal Gain over Quiescent Drain Current vs.  $P_{IN}$**

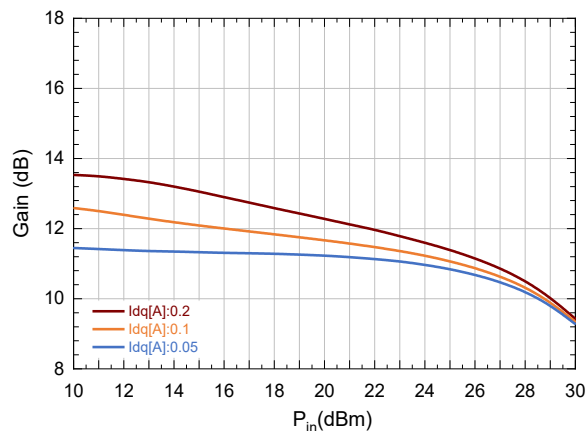

**Typical Performance Curves as Measured in the 2 - 6 GHz Evaluation Test Fixture:**

For Engineering Evaluation Only—This data does not Modify MACOM's Datasheet Limits.

CW,  $I_{DQ} = 100$  mA,  $P_{IN} = -10$  dBm

**S21 over Temperature vs. Frequency @ 28 V**

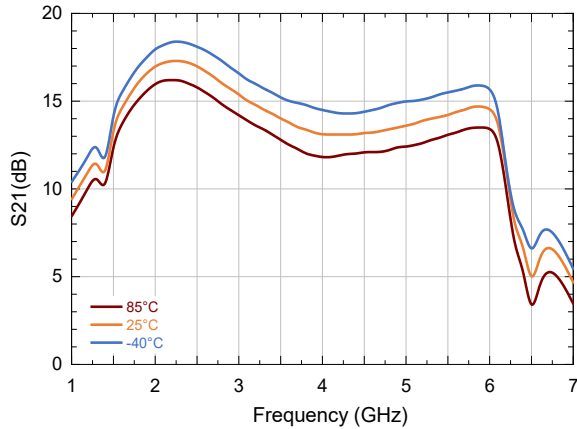

**S21 over Voltage vs. Frequency @ 25°C**

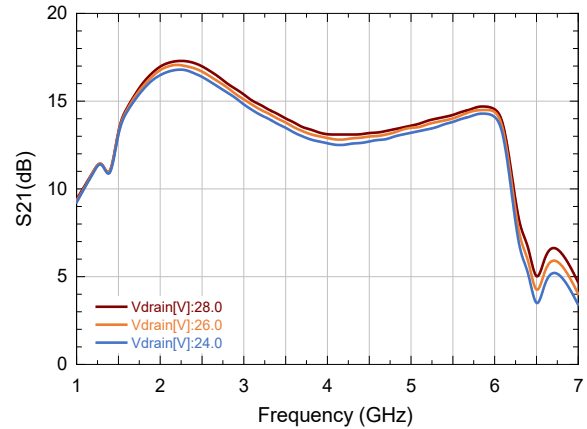

**S11 over Temperature vs. Frequency @ 28 V**

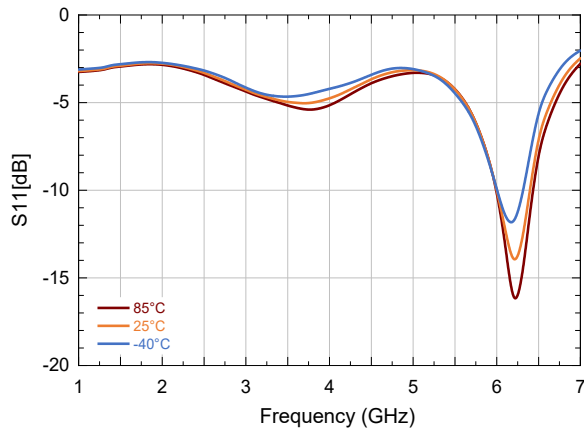

**S11 Voltage vs. Frequency @ 25°C**

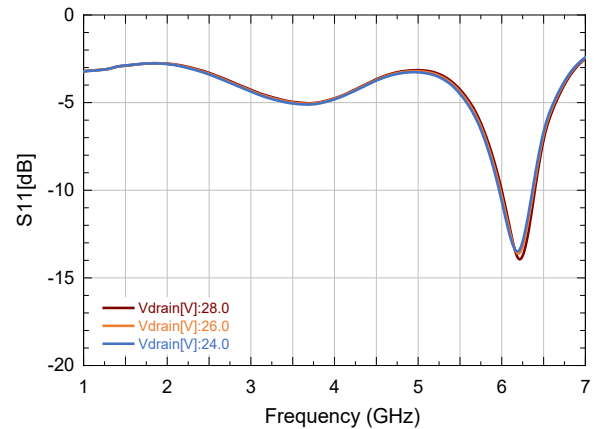

**S22 over Temperature vs. Frequency @ 28 V**

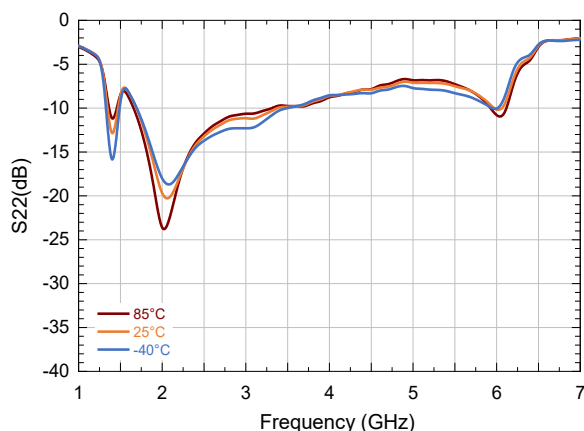

**S22 Voltage vs. Frequency @ 25°C**

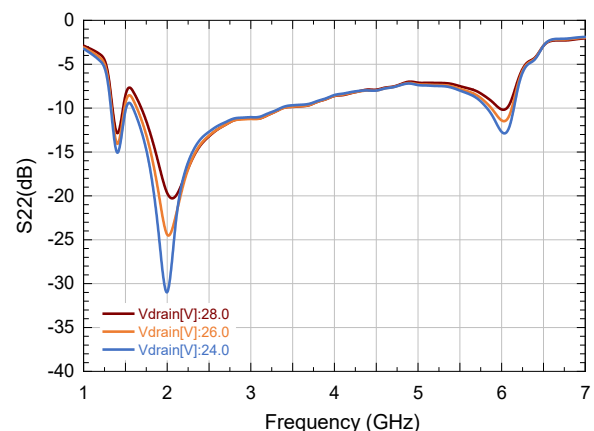

**Typical Performance Curves as Measured in the 2 - 6 GHz Evaluation Test Fixture:**

For Engineering Evaluation Only—This data does not Modify MACOM's Datasheet Limits.  
CW,  $I_{DQ} = 100 \text{ mA}$ ,  $P_{IN} = -10 \text{ dBm}$

**S21 over Quiescent Drain Current vs. Frequency**

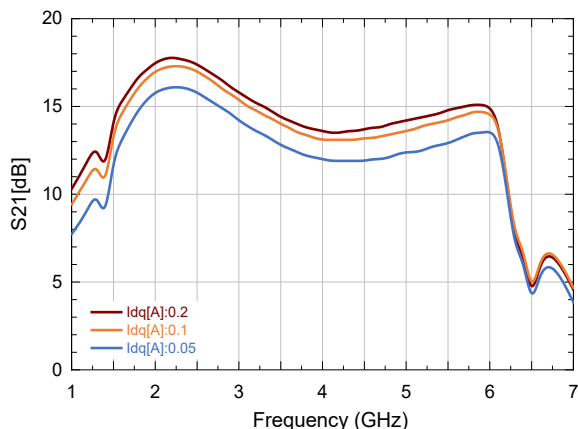

**S11 over Quiescent Drain Current vs. Frequency**

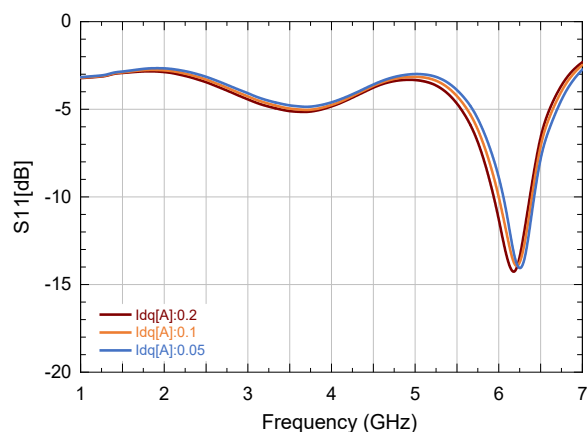

**S22 over Quiescent Drain Current vs. Frequency**

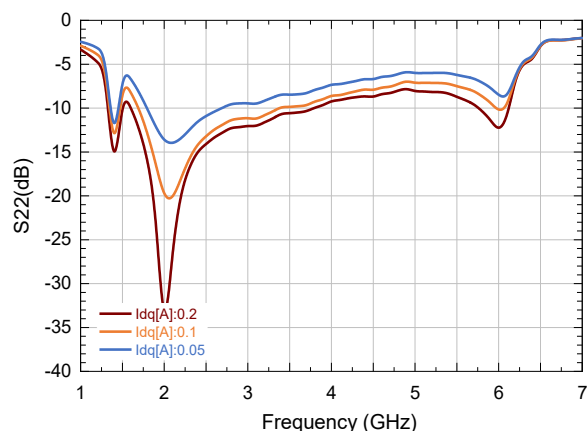

Lead-free 3 x 4 mm 12-Lead Package Dimensions

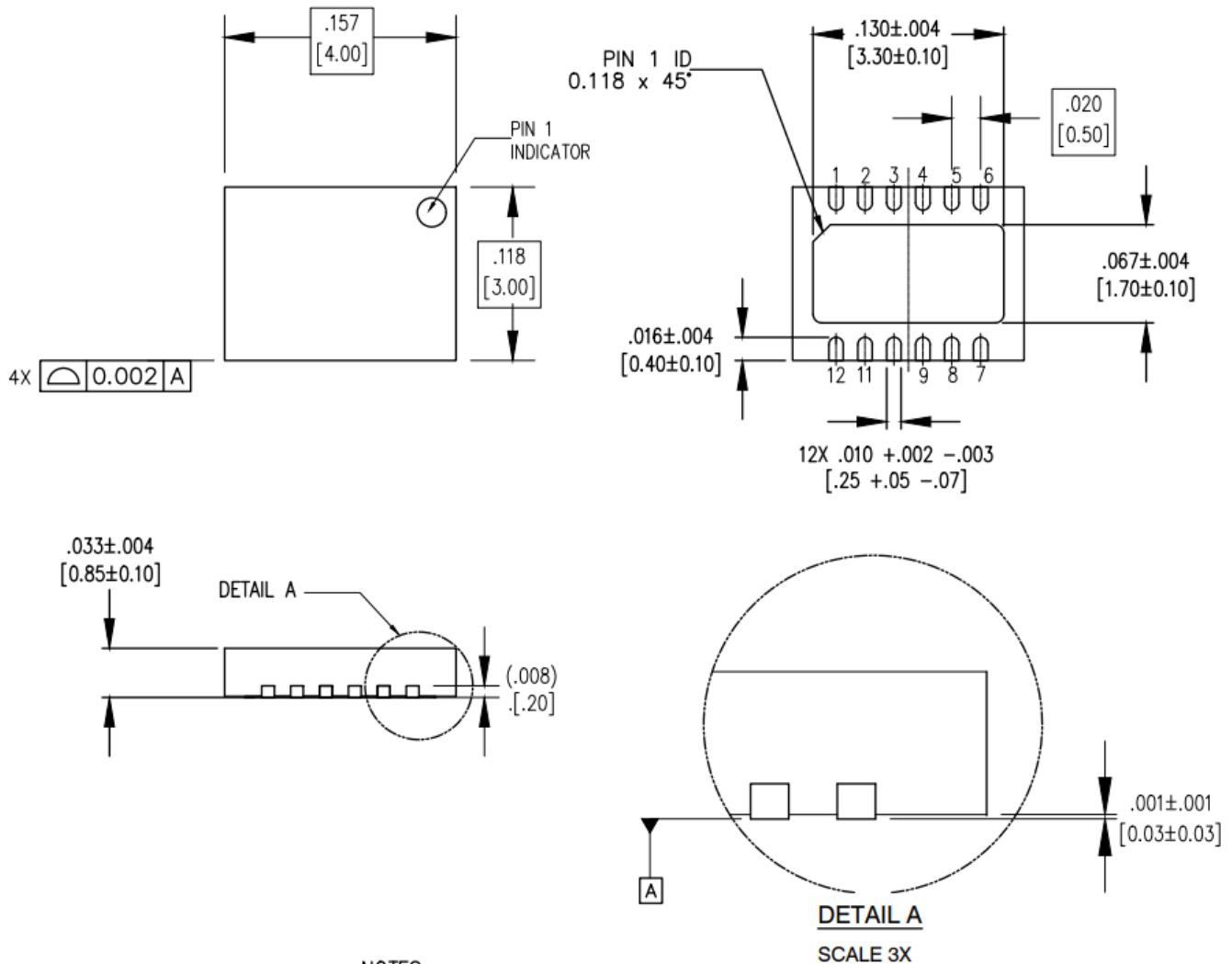

NOTES:

1. ALL DIMENSIONS SHOWN AS in[mm]. CONTROLLING DIMENSIONS ARE IN in. CONVERTED mm DIMENSIONS ARE NOT NECESSARILY EXACT.
2. EXPOSED LEADS 100% Sn MATTE.

MACOM Technology Solutions Inc. ("MACOM"). All rights reserved.

These materials are provided in connection with MACOM's products as a service to its customers and may be used for informational purposes only. Except as provided in its Terms and Conditions of Sale or any separate agreement, MACOM assumes no liability or responsibility whatsoever, including for (i) errors or omissions in these materials; (ii) failure to update these materials; or (iii) conflicts or incompatibilities arising from future changes to specifications and product descriptions, which MACOM may make at any time, without notice. These materials grant no license, express or implied, to any intellectual property rights.

THESE MATERIALS ARE PROVIDED "AS IS" WITH NO WARRANTY OR LIABILITY, EXPRESS OR IMPLIED, RELATING TO SALE AND/OR USE OF MACOM PRODUCTS INCLUDING FITNESS FOR A PARTICULAR PURPOSE, MERCHANTABILITY, INFRINGEMENT OF INTELLECTUAL PROPERTY RIGHT, ACCURACY OR COMPLETENESS, OR SPECIAL, INDIRECT, INCIDENTAL, OR CONSEQUENTIAL DAMAGES WHICH MAY RESULT FROM USE OF THESE MATERIALS.

MACOM products are not intended for use in medical, lifesaving or life sustaining applications. MACOM customers using or selling MACOM products for use in such applications do so at their own risk and agree to fully indemnify MACOM for any damages resulting from such improper use or sale.