

Features

- MACOM PURE CARBIDE™ Amplifier Series
- Suitable for Linear & Saturated Applications
- CW & Pulsed Operation: 270 W Output Power
- Internally Pre-Matched
- 28 V and 50 V Operation
- Compatible with MACOM Power Management Bias Controller/Sequencer MABC-11040

Applications

Military Radio Communications, RADAR, Avionics, Digital Cellular Infrastructure, RF Energy, and Test Instrumentation.

Description

The MAPC-A1103 is a high power GaN on Silicon Carbide HEMT D-mode amplifier suitable for DC - 2.7 GHz frequency operation. The device supports both CW and pulsed operation with output power levels of at least 270 W (54.3 dBm) in an air cavity ceramic package.

Typical Performance:

One side measured under load-pull at 2.5 dB compression, 100 μs pulse width, 10% duty cycle.

- $V_{DS} = 50\text{ V}$, $I_{DQ} = 220\text{ mA}$, $T_C = 25^\circ\text{C}$

Frequency (GHz)	Output Power ¹ (dBm)	Gain ² (dB)	η_D^2 (%)
0.9	51.7	23.4	71.5
1.4	51.7	20.0	74.5
2.0	52.5	17.9	67.9
2.5	52.0	16.8	69.1
2.7	51.9	16.3	70.2

- $V_{DS} = 28\text{ V}$, $I_{DQ} = 220\text{ mA}$, $T_C = 25^\circ\text{C}$

Frequency (GHz)	Output Power ¹ (dBm)	Gain ² (dB)	η_D^2 (%)
0.9	48.9	21.4	70.3
1.4	48.8	18.0	71.9
2.0	50.0	16.3	72.2
2.5	49.3	15.0	69.8
2.7	49.3	14.8	71.7

1. Load impedance tuned for maximum output power.
2. Load impedance tuned for maximum drain efficiency.

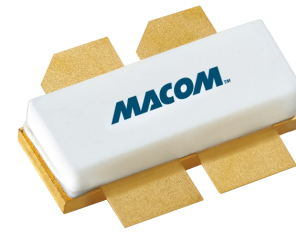

AC-650S-4

Functional Schematic

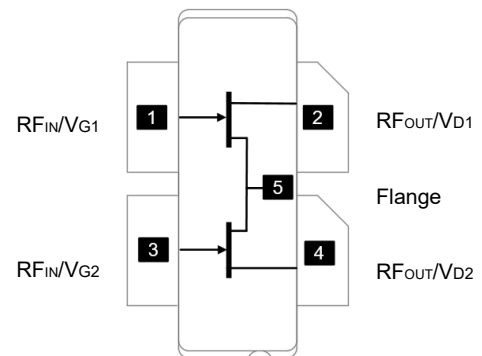

Pin Configuration

Pin #	Pin Name	Function
1	RF _{IN} / V _{G1}	RF Input / Gate
2	RF _{OUT} / V _{D1}	RF Output / Drain
3	RF _{IN} / V _{G2}	RF Input / Gate
4	RF _{OUT} / V _{D2}	RF Output / Drain
5	Flange ³	Ground / Source

3. The flange on the package bottom must be connected to RF, DC and thermal ground.

Ordering Information

Part Number	Package
MAPC-A1103-AS000	Bulk Quantity
MAPC-A1103-ASTR1	Tape and Reel
MAPC-A1103-ASSB1	Sample Board

¹ * Restrictions on Hazardous Substances, compliant to current RoHS EU directive.

RF Electrical Characteristics: $T_C = 25^\circ\text{C}$, $V_{DS} = 50\text{ V}$, $I_{DQ} = 430\text{ mA}$
Note: Performance in MACOM Evaluation Test Fixture, 50 Ω system

Parameter	Test Conditions	Symbol	Min.	Typ.	Max.	Units
Small Signal Gain	Pulsed ⁴ , 2.6 GHz	G_{SS}	-	18.4	-	dB
Power Gain	Pulsed ⁴ , 2.6 GHz, 2.5 dB Gain Compression	G_{SAT}	-	16.1	-	dB
Saturated Drain Efficiency	Pulsed ⁴ , 2.6 GHz, 2.5 dB Gain Compression	η_{SAT}	-	68.2	-	%
Saturated Output Power	Pulsed ⁴ , 2.6 GHz, 2.5 dB Gain Compression	P_{SAT}	-	53.5	-	dBm
Gain Variation (-40°C to +85°C)	Pulsed ⁴ , 2.6 GHz	ΔG	-	0.013	-	dB/°C
Power Variation (-40°C to +85°C)	Pulsed ⁴ , 2.6 GHz	$\Delta P_{2.5dB}$	-	0.005	-	dB/°C
Power Gain	Pulsed ⁴ , 2.6 GHz, $P_{IN} = 36.5\text{ dBm}$	G_P	-	16.7	-	dB
Drain Efficiency	Pulsed ⁴ , 2.6 GHz, $P_{IN} = 36.5\text{ dBm}$	η	-	67.6	-	%
Ruggedness: Output Mismatch	All phase angles	Ψ	VSWR = 10:1, No Damage			

RF Electrical Specifications: $T_A = 25^\circ\text{C}$, $V_{DS} = 50\text{ V}$, $I_{DQ} = 430\text{ mA}$
Note: Performance in MACOM Production Test Fixture, 50 Ω system

Parameter	Test Conditions	Symbol	Min.	Typ.	Max.	Units
Power Gain	Pulsed ⁴ , 2.6 GHz, 2.5 dB Gain Compression	G_{SAT}	15.3	16.1	-	dB
Saturated Drain Efficiency	Pulsed ⁴ , 2.6 GHz, 2.5 dB Gain Compression	η_{SAT}	63.4	68.2	-	%
Saturated Output Power	Pulsed ⁴ , 2.6 GHz, 2.5 dB Gain Compression	P_{SAT}	52.6	53.5	-	dBm
Power Gain	Pulsed ⁴ , 2.6 GHz, $P_{IN} = 36.5\text{ dBm}$	G_P	15.9	16.7	-	dB
Drain Efficiency	Pulsed ⁴ , 2.6 GHz, $P_{IN} = 36.5\text{ dBm}$	η	63.2	67.6	-	%

4. Pulse details: 100 μs pulse width, 10% duty cycle.

DC Electrical Characteristics (Per Each Side of Symmetric Device) $T_A = 25^\circ\text{C}$

Parameter	Test Conditions	Symbol	Min.	Typ.	Max.	Units
Drain-Source Leakage Current	$V_{GS} = -8\text{ V}$, $V_{DS} = 130\text{ V}$	I_{DLK}	-	-	13.5	mA
Gate-Source Leakage Current	$V_{GS} = -8\text{ V}$, $V_{DS} = 0\text{ V}$	I_{GLK}	-	-	13.5	mA
Gate Threshold Voltage	$V_{DS} = 50\text{ V}$, $I_D = 13.5\text{ mA}$	V_T	-3.6	-3.1	-	V
Gate Quiescent Voltage	$V_{DS} = 50\text{ V}$, $I_D = 220\text{ mA}$	V_{GSQ}	-	-2.6	-	V
On Resistance	$V_{GS} = 2\text{ V}$, $I_D = 101\text{ mA}$	R_{ON}	-	0.15	-	Ω
Maximum Drain Current	$V_{DS} = 7\text{ V}$ pulsed, pulse width 300 μs	$I_{D, MAX}$	-	16.1	-	A

Absolute Maximum Ratings (Per Each Side of Symmetric Device)^{5,6,7,8,9}

Parameter	Absolute Maximum
Drain Source Voltage, V_{DS}	130 V
Gate Source Voltage, V_{GS}	-10 to 3 V
Gate Current, I_G	13.5 mA
Storage Temperature Range	-65°C to +150°C
Case Operating Temperature Range	-40°C to +85°C
Channel Operating Temperature Range, T_{CH}	-40°C to +225°C
Absolute Maximum Channel Temperature	+250°C

5. Exceeding any one or combination of these limits may cause permanent damage to this device.
6. MACOM does not recommend sustained operation above maximum operating conditions.
7. Operating at drain source voltage $V_{DS} < 55$ V will ensure $MTTF > 2 \times 10^6$ hours.
8. Operating at nominal conditions with $T_{CH} \leq 225^\circ\text{C}$ will ensure $MTTF > 2 \times 10^6$ hours.
9. $MTTF$ may be estimated by the expression $MTTF$ (hours) = $A e^{\frac{B+C}{T+273}}$ where T is the channel temperature in degrees Celsius, $A = 1$, $B = -38.215$, and $C = 26,343$.

Thermal Characteristics¹⁰

Parameter	Test Conditions	Symbol	Typical	Units
Thermal Resistance using Finite Element Analysis	$V_{DS} = 50$ V, $T_C = 85^\circ\text{C}$, $T_{CH} = 225^\circ\text{C}$	$R_{\theta}(\text{FEA})$	1.16	°C/W
Thermal Resistance using Infrared Measurement of Die Surface Temperature	$V_{DS} = 50$ V, $T_C = 85^\circ\text{C}$, $T_{CH} = 225^\circ\text{C}$	$R_{\theta}(\text{IR})$	0.93	°C/W

10. Case temperature measured using thermocouple embedded in heat-sink. Contact local applications support team for more details on this measurement.

Handling Procedures

Please observe the following precautions to avoid damage:

Static Sensitivity

Gallium Nitride Circuits are sensitive to electrostatic discharge (ESD) and can be damaged by static electricity. Proper ESD control techniques should be used when handling these devices.

50 V Pulsed⁴ Load-Pull Performance (Per Each Side of Symmetric Device)
Reference Plane at Device Leads

Frequency (GHz)	Z_{SOURCE} (Ω)	Maximum Output Power					
		$V_{DS} = 50\text{ V}, I_{DQ} = 220\text{ mA}, T_C = 25^\circ\text{C}, P_{2.5dB}$					
		Z_{LOAD}^{11} (Ω)	Gain (dB)	P_{OUT} (dBm)	P_{OUT} (W)	η_D (%)	AM/PM ($^\circ$)
0.9	0.9 + j0.0	5.9 + j1.7	22.3	51.7	147.9	66.0	64.0
1.4	1.0 - j2.8	4.4 + j1.2	18.3	51.7	147.9	66.3	48.6
2.0	1.1 - j5.8	4.0 + j0.3	16.2	52.5	177.6	58.3	33.3
2.5	2.3 - j10.2	3.6 - j0.6	15.2	52.0	158.7	60.8	18.6
2.7	3.6 - j12.1	3.4 - j1.0	15.2	51.9	156.0	63.0	8.1

Frequency (GHz)	Z_{SOURCE} (Ω)	Maximum Drain Efficiency					
		$V_{DS} = 50\text{ V}, I_{DQ} = 220\text{ mA}, T_C = 25^\circ\text{C}, P_{2.5dB}$					
		Z_{LOAD}^{12} (Ω)	Gain (dB)	P_{OUT} (dBm)	P_{OUT} (W)	η_D (%)	AM/PM ($^\circ$)
0.9	0.8 - j0.2	8.8 + j7.2	23.4	49.7	93.1	71.5	48.4
1.4	0.6 - j3.1	4.3 + j4.8	20.0	50.3	108.3	74.5	31.9
2.0	0.9 - j6.3	3.6 + j2.6	17.9	51.6	144.6	67.9	21.9
2.5	1.9 - j10.9	2.9 + j1.4	16.8	51.2	132.8	69.1	7.4
2.7	3.0 - j13.2	2.5 + j1.0	16.3	51.2	132.8	70.2	-2.7

Impedance Reference

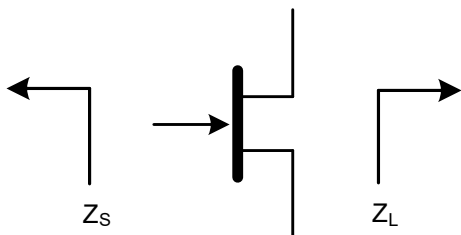

Z_{SOURCE} = Measured impedance presented to the input of the device at package reference plane.
 Z_{LOAD} = Measured impedance presented to the output of the device at package reference plane.

- 11. Load Impedance for optimum output power.
- 12. Load Impedance for optimum efficiency.

Pulsed⁴ Load-Pull Performance (Per Each Side of Symmetric Device) @ 2.5 GHz

P2.5dB Loadpull Output Power Contours (dBm)

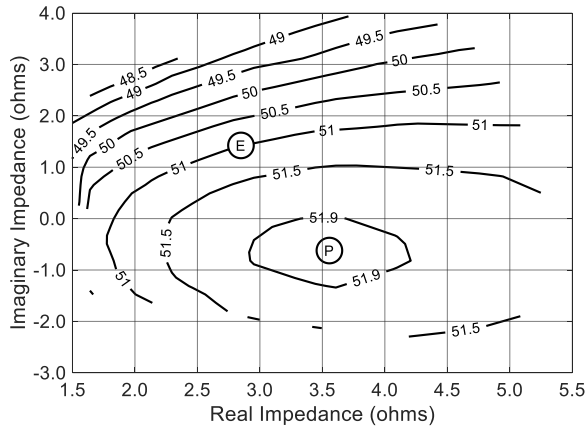

P2.5dB Loadpull Drain Efficiency Contours (%)

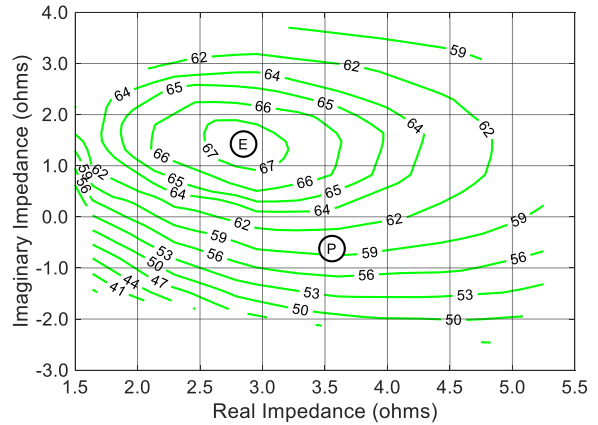

P2.5dB Loadpull Gain Contours (dB)

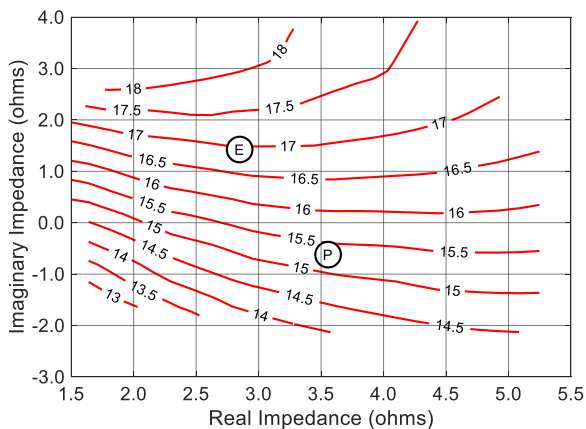

P2.5dB Loadpull AM/PM Contours (°)

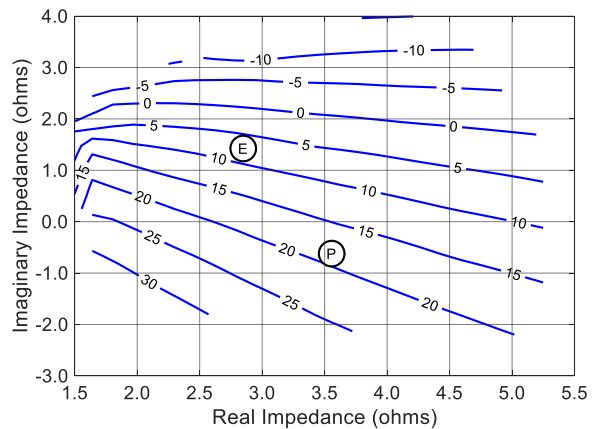

Gain vs. Output Power

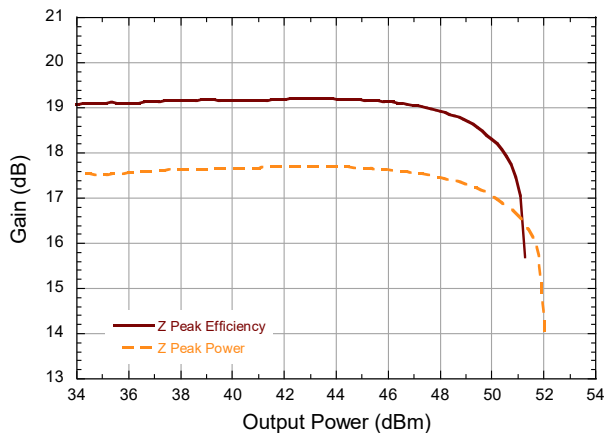

Drain Efficiency vs. Output Power

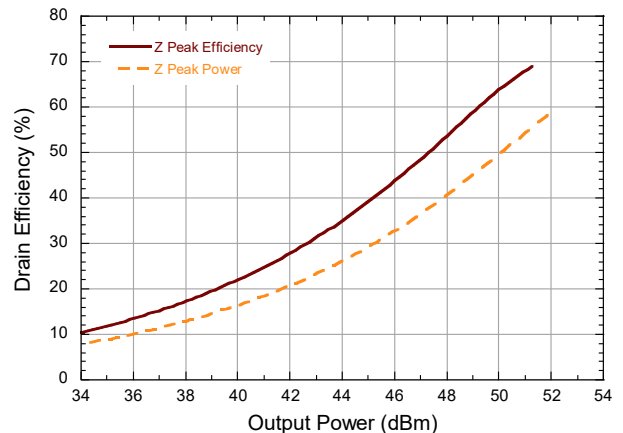

28 V Pulsed⁴ Load-Pull Performance (Per Each Side of Symmetric Device)
Reference Plane at Device Leads

Frequency (GHz)	Z _{SOURCE} (Ω)	Maximum Output Power					
		V _{DS} = 28 V, I _{DQ} = 220 mA, T _C = 25°C, P2.5dB					
		Z _{LOAD} ¹¹ (Ω)	Gain (dB)	P _{OUT} (dBm)	P _{OUT} (W)	η _D (%)	AM/PM (°)
0.9	1.0 + j0.0	3.6 - j0.1	19.5	48.9	77.2	58.0	70.0
1.4	0.9 - j3.0	3.0 - j0.5	16.6	48.8	75.7	64.6	55.7
2.0	1.2 - j6.2	3.1 - j1.5	14.0	50.0	99.8	58.1	40.1
2.5	2.3 - j10.3	2.9 - j2.2	13.3	49.3	85.7	61.0	26.7
2.7	3.8 - j12.8	2.8 - j2.6	13.4	49.3	84.6	65.4	15.4

Frequency (GHz)	Z _{SOURCE} (Ω)	Maximum Drain Efficiency					
		V _{DS} = 28 V, I _{DQ} = 220 mA, T _C = 25°C, P2.5dB					
		Z _{LOAD} ¹² (Ω)	Gain (dB)	P _{OUT} (dBm)	P _{OUT} (W)	η _D (%)	AM/PM (°)
0.9	0.5 - j0.6	5.9 + j2.8	21.4	47.6	57.0	70.3	56.5
1.4	0.7 - j3.3	4.0 + j2.4	18.0	47.5	55.7	71.9	38.0
2.0	0.9 - j6.4	3.0 + j0.9	16.3	48.4	69.5	72.2	21.8
2.5	2.1 - j11.7	2.6 - j0.2	15.0	48.0	63.0	69.8	12.8
2.7	3.4 - j13.8	2.3 - j0.6	14.8	47.7	58.6	71.7	0.9

Impedance Reference

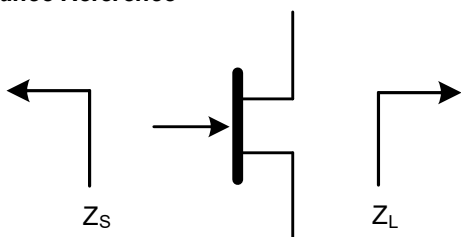

Z_{SOURCE} = Measured impedance presented to the input of the device at package reference plane.

Z_{LOAD} = Measured impedance presented to the output of the device at package reference plane.

- 11. Load Impedance for optimum output power.
- 12. Load Impedance for optimum efficiency.

Evaluation Test Fixture and Recommended Tuning Solution 2.55 - 2.65 GHz

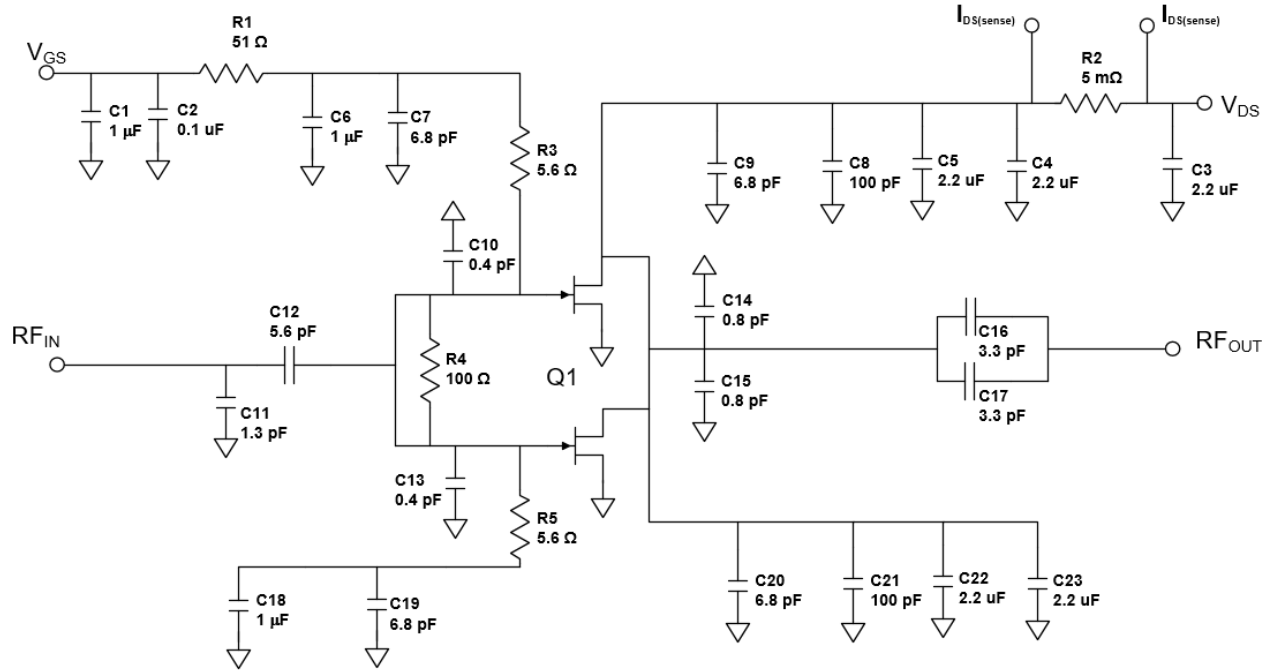

Description

Parts measured on evaluation board (20-mil thick RO4350). Matching is provided using a combination of lumped elements and transmission lines as shown in the simplified schematic above. Recommended tuning solution component placement, transmission lines, and details are shown on the next page.

Bias Sequencing

Turning the device ON

1. Set V_{GS} to pinch-off (V_P).
2. Turn on V_{DS} to nominal voltage (50 V).
3. Increase V_{GS} until I_{DS} current is reached.
4. Apply RF power to desired level.

Turning the device OFF

1. Turn the RF power OFF.
2. Decrease V_{GS} down to V_P pinch-off.
3. Decrease V_{DS} down to 0 V.
4. Turn off V_{GS} .

Evaluation Test Fixture and Recommended Tuning Solution 2.55 - 2.65 GHz

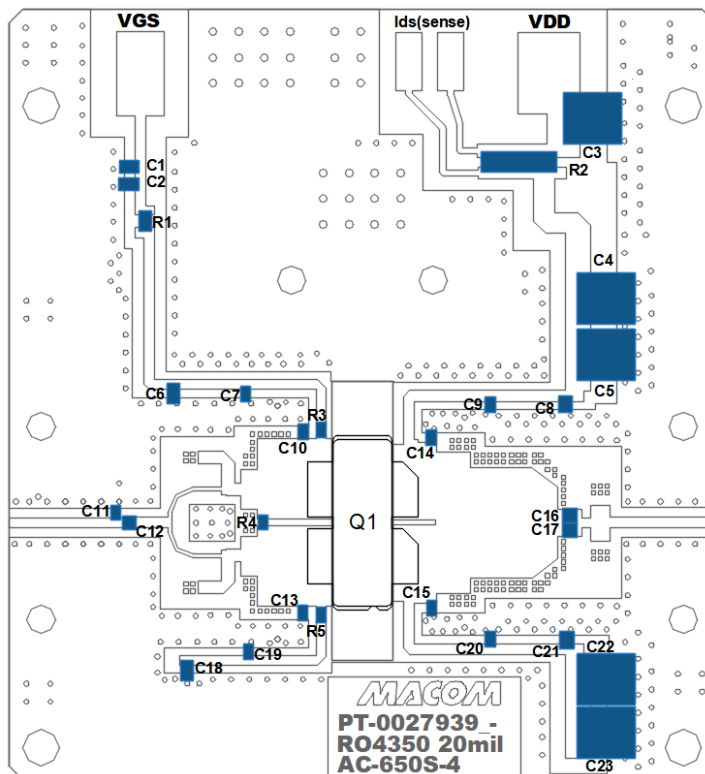

Reference Designator	Value	Tolerance	Manufacturer	Part Number
C1,C6,C18	1.0 μ F	+/- 10 %	Murata	GRM21BC72A105KE01L
C2	0.1 μ F	+/- 10 %	Murata	GCD21BR72A104KA01L
C3,C4,C5,C22,C23	2.2 μ F	+/- 20 %	Murata	KRM55TR72E225MH01L
C7,C9, C19,C20	6.8 pF	+/- 0.25pF	PPI	0505C6R8CW151X
C8,C21	100 pF	+/- 5 %	Murata	GQM2195C2E101JB12
C10,C13	0.4 pF	+/- 0.1 pF	PPI	0505C0R4BW151X
C11	1.3 pF	+/- 0.1 pF	Murata	GQM1875C2E1R3BB12D
C12	5.6 pF	+/- 0.25 pF	PPI	0505C5R6CW151X
C14,C15	0.8 pF	+/- 0.1 pF	Murata	GQM1875C2ER80BB12D
C16,C17	3.3 pF	+/- 0.25 pF	PPI	0505C3R3CW151X
R1	51 Ω	+/- 1%	Yageo	RT0805FRE0751RL
R2	5 m Ω	+/- 1%	Susumu	RL7520WT-R005-F
R3,R5	5.6 Ω	+/- 1%	Vishay	MCT06030C5608FP500
R4	100 Ω	+/- 1%	Vishay	MCT06030C1000FP500
Q1	MACOM GaN Power Amplifier		MAPC-A1103	
PCB	RO4350, 20 mil, 1 oz. Cu, Au Finish			

Typical Performance Curves as Measured in the 2.55 - 2.65 GHz Evaluation Test Fixture:
Pulsed⁴ 2.6 GHz, $V_{DS} = 50$ V, $I_{DQ} = 430$ mA, $T_C = 25^\circ\text{C}$ (Unless Otherwise Noted)

Gain vs. Output Power and Frequency

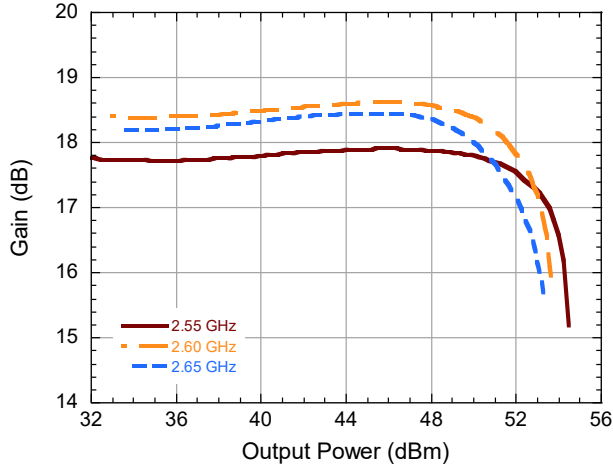

Drain Efficiency vs. Output Power and Frequency

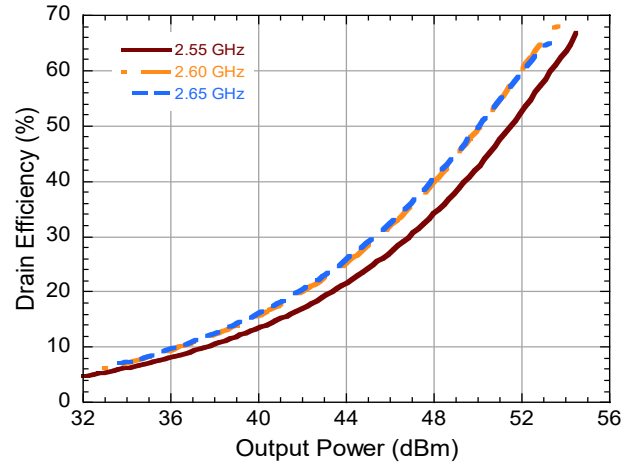

Gain vs. Output Power and V_{DS}

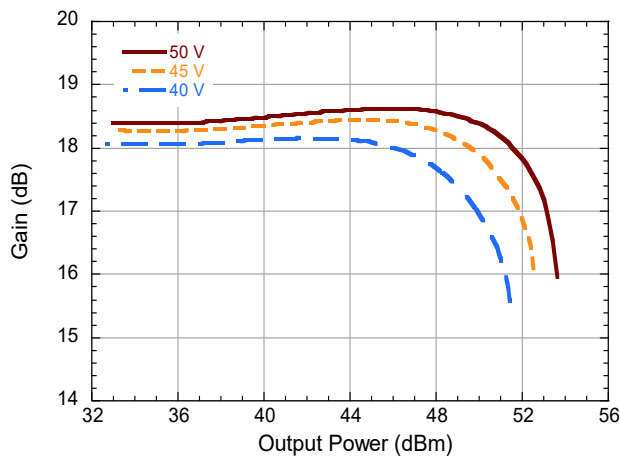

Drain Efficiency vs. Output Power and V_{DS}

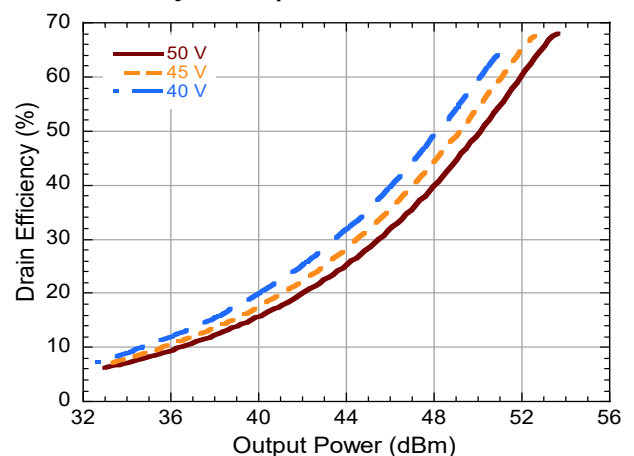

Gain vs. Output Power and I_{DQ}

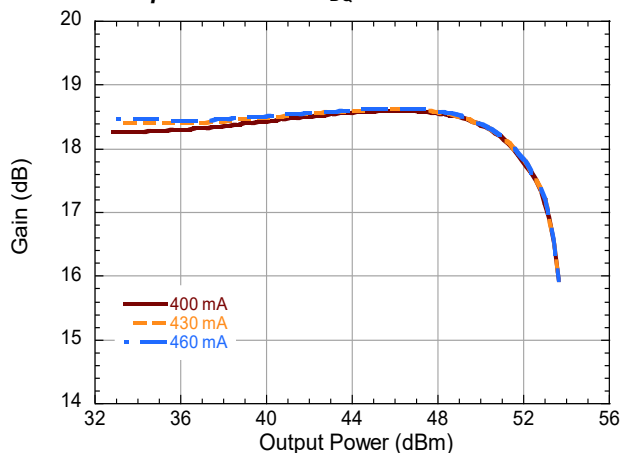

Drain Efficiency vs. Output Power and I_{DQ}

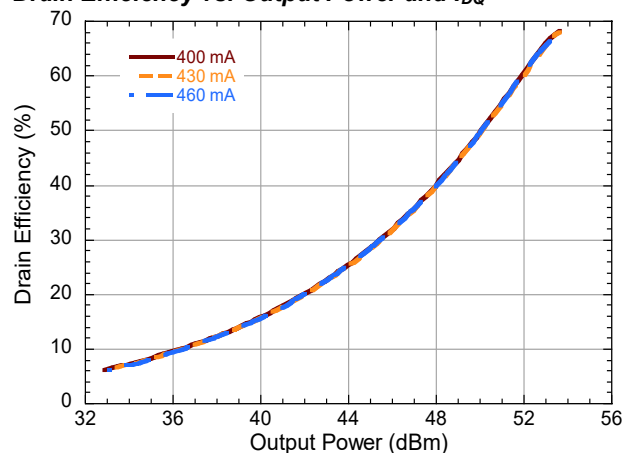

Typical Performance Curves as Measured in the 2.55 - 2.65 GHz Evaluation Test Fixture:
Pulsed⁴ 2.6 GHz, $V_{DS} = 50$ V, $I_{DQ} = 430$ mA, $T_C = 25^\circ\text{C}$ (Unless Otherwise Noted)

Gain vs. Output Power and T_C

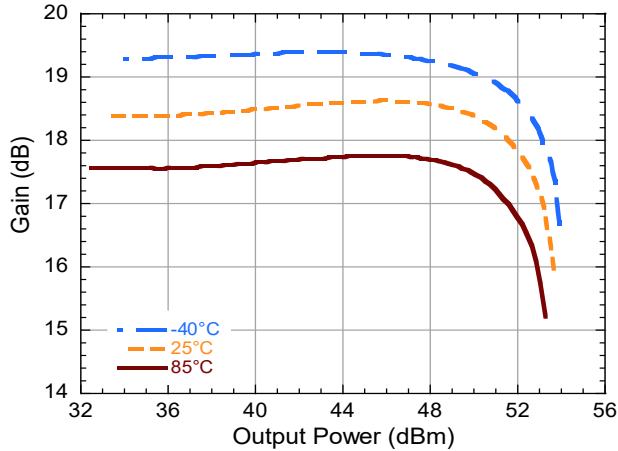

Drain Efficiency vs. Output Power and T_C

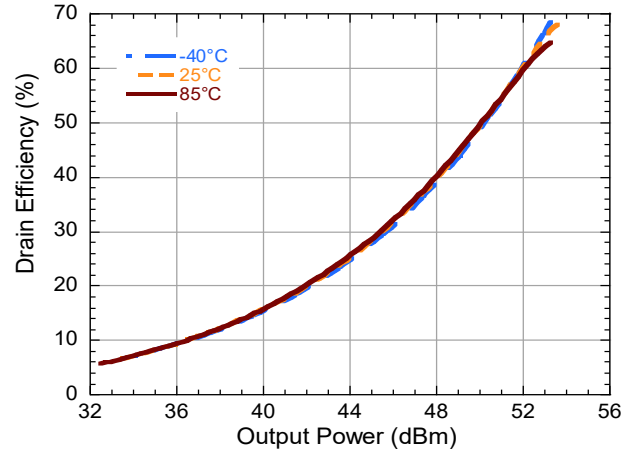

Gain vs. Frequency, 2.5dB Gain Compression

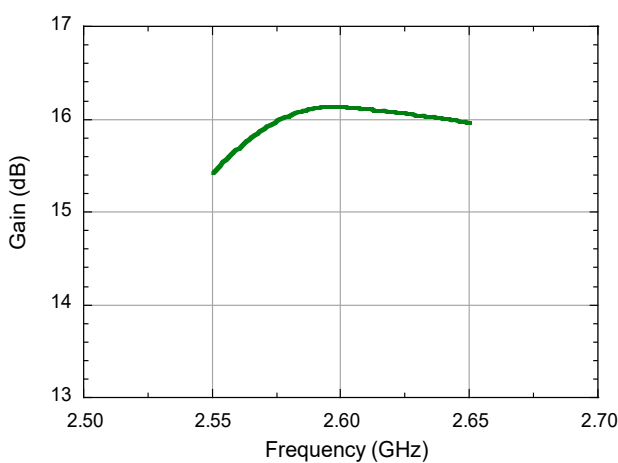

Drain Efficiency vs. Frequency, 2.5dB Gain Compression

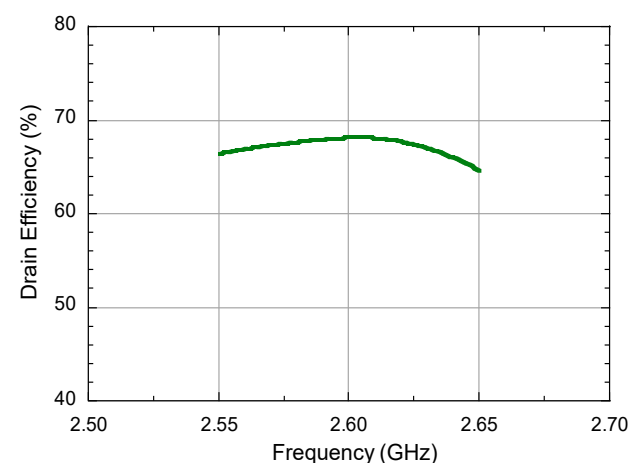

Output Power vs. Frequency, 2.5dB Gain Compression

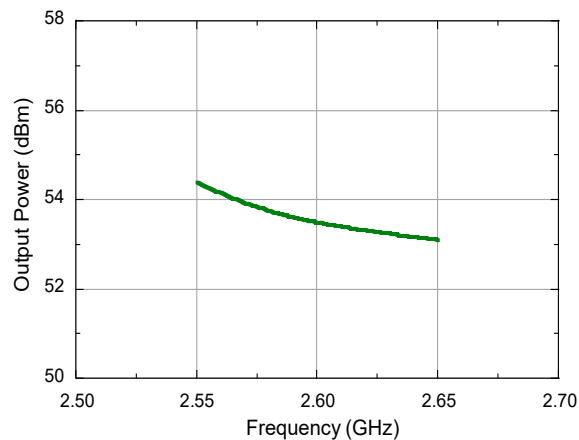

Lead-Free AC-650S-4 Package Dimensions[†]

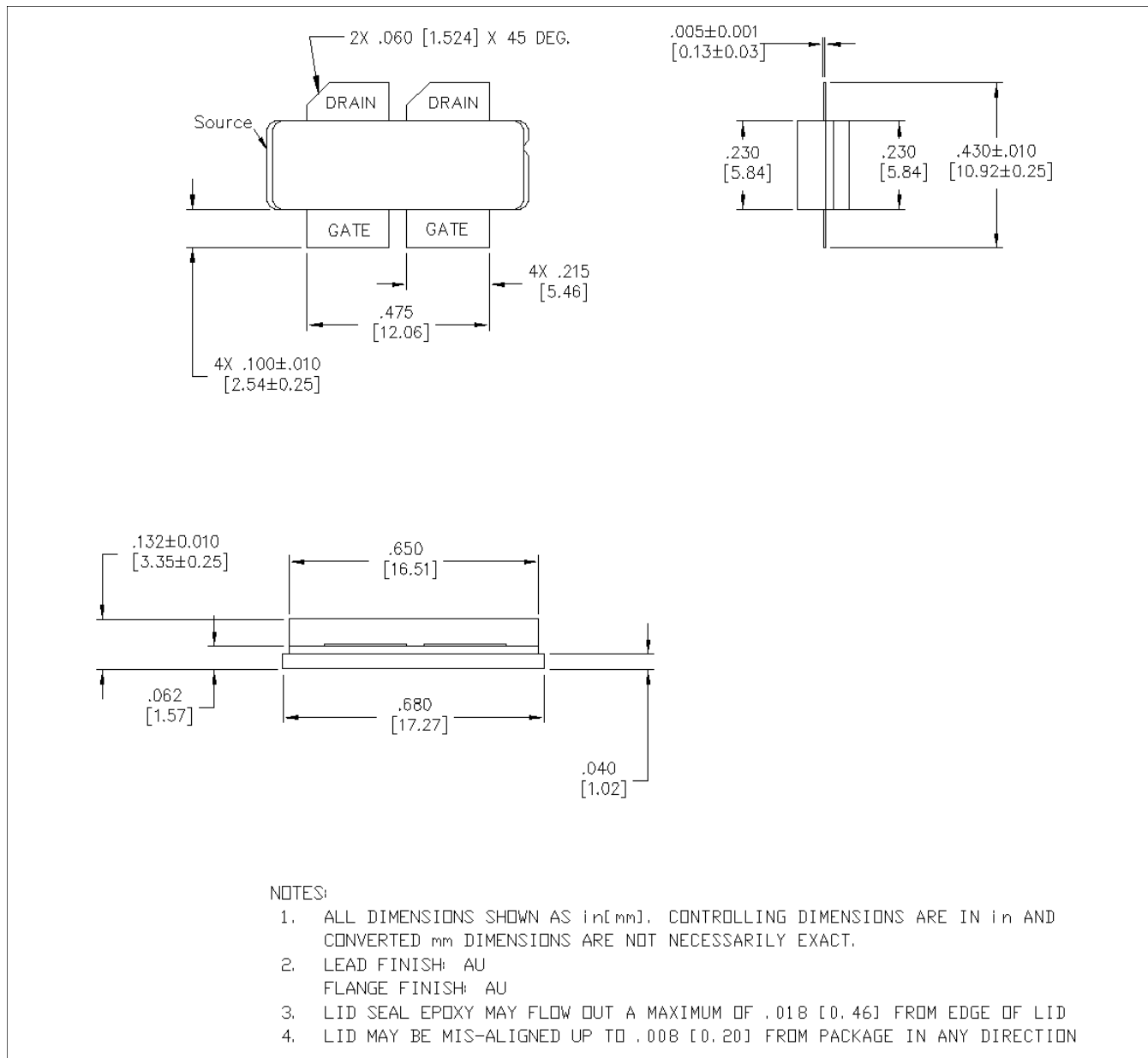

[†] Reference Application Note AN0004363 for lead-free solder reflow recommendations.
Meets JEDEC moisture sensitivity level 3 requirements.
Plating is Au.

MACOM Technology Solutions Inc. ("MACOM"). All rights reserved.

These materials are provided in connection with MACOM's products as a service to its customers and may be used for informational purposes only. Except as provided in its Terms and Conditions of Sale or any separate agreement, MACOM assumes no liability or responsibility whatsoever, including for (i) errors or omissions in these materials; (ii) failure to update these materials; or (iii) conflicts or incompatibilities arising from future changes to specifications and product descriptions, which MACOM may make at any time, without notice. These materials grant no license, express or implied, to any intellectual property rights.

THESE MATERIALS ARE PROVIDED "AS IS" WITH NO WARRANTY OR LIABILITY, EXPRESS OR IMPLIED, RELATING TO SALE AND/OR USE OF MACOM PRODUCTS INCLUDING FITNESS FOR A PARTICULAR PURPOSE, MERCHANTABILITY, INFRINGEMENT OF INTELLECTUAL PROPERTY RIGHT, ACCURACY OR COMPLETENESS, OR SPECIAL, INDIRECT, INCIDENTAL, OR CONSEQUENTIAL DAMAGES WHICH MAY RESULT FROM USE OF THESE MATERIALS.

MACOM products are not intended for use in medical, lifesaving or life sustaining applications. MACOM customers using or selling MACOM products for use in such applications do so at their own risk and agree to fully indemnify MACOM for any damages resulting from such improper use or sale.