

Image-Reject Mixer

8 - 26 GHz



MAMX-011040-DIE

Rev. V1

Features

- Low Conversion Loss: 8 dB
- High Linearity: 17 dBm IIP3
- High Image Rejection: 22 dBc
- Wide IF Bandwidth: DC to 4 GHz
- High Isolation
- Die Size: 1.40 × 1.58 × 0.10 mm
- RoHS* Compliant

Applications

- Test & Measurement, Microwave Radio, and Radar

Description

MAMX-011040-DIE is an image-reject passive diode mixer MMIC. The mixer offers low conversion loss, high linearity, high image rejection and a wide IF bandwidth. The image-reject circuit configuration provides excellent port isolation while internal 50 Ω matching simplifies its application.

This mixer is well suited for applications such as test and measurement, microwave radio and radar.

MAMX-011040-DIE is also available in a 4 mm QFN package. Refer to datasheet MAMX-011040.

Ordering Information

| Part Number | Package |
|-----------------|--------------------------------------|
| MAMX-011040-DIE | Vacuum Release Gel Pack ¹ |
| MAMX-011040-SB2 | Sample Board |

1. Die quantity varies.

Functional Schematic

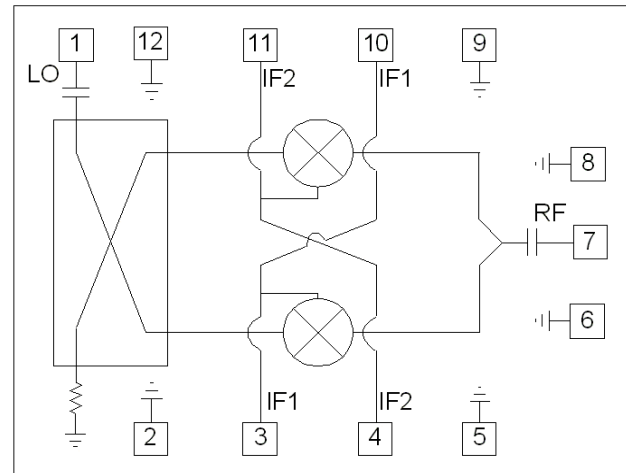

Bond-pad Configuration

| Pin # | Function |
|-------------------|---------------------|
| 1 | LO |
| 2, 5, 6, 8, 9, 12 | Ground ² |
| 3 | (IF1) ³ |
| 4 | (IF2) ³ |
| 7 | RF |
| 10 | (IF1) ³ |
| 11 | (IF2) ³ |
| 13 | Ground ⁴ |

2. These pads are internally connected to ground, and they can be left unconnected.

3. Only one side IF1 and IF2 need to be connected, and leave the other side IF1 and IF2 unconnected.

4. The backside of the die must be connected to RF, DC and thermal ground.

* Restrictions on Hazardous Substances, compliant to current RoHS EU directive.

Electrical Specifications^{5,6}: $F_{IF} = 100 \text{ MHz}$, $P_{LO} = +14 \text{ dBm}$, $T_A = 25^\circ\text{C}$, $Z_0 = 50 \Omega$

| Parameter | Test Conditions | Units | Min. | Typ. | Max. |
|---------------------|--|-------|------|----------|-----------|
| LO and RF Frequency | — | GHz | 8 | — | 26 |
| IF Frequency | — | GHz | 0 | — | 4 |
| LO Power | — | dBm | — | 14 | — |
| Conversion Loss | 8 - 24 GHz 24 - 26 GHz | dB | — | 8 | 9.5 11 |
| Input P1dB | — | dBm | — | 6 | — |
| Input IP3 | $P_{RF} = -10 \text{ dBm/tone}$, $\Delta f = 1 \text{ MHz}$ | dBm | — | 17 | — |
| Input IP2 (Half IF) | $P_{RF} = -10 \text{ dBm/tone}$, $\Delta f = 1 \text{ MHz}$ | dBm | — | 40 | — |
| LO-to-RF Isolation | — | dB | — | 35 | — |
| LO-to-IF Isolation | — | dB | — | 35 | — |
| RF-to-IF Isolation | — | dB | — | 15 | — |
| Image Rejection | 8 - 26 GHz | dBc | 17 | 22 | — |
| Amplitude Imbalance | — | dBc | — | ± 2 | — |
| Phase Imbalance | — | ° | — | ± 10 | — |
| RF Return Loss | RF = 18 GHz | dB | — | 6 | — |
| IF Return Loss | IF = 2 GHz | dB | — | 12 | — |

5. All specifications refer to down-conversion operation, unless otherwise noted.

6. Characterization measurements were taken using RF probes, with I/O port configuration shown in Assembly Guideline Diagram on page 8.

Absolute Maximum Ratings^{7,8}

| Parameter | Absolute Maximum |
|-----------------------------------|------------------|
| LO Power | 23 dBm |
| RF or IF Power | 20 dBm |
| Junction Temperature ⁹ | +150°C |
| Operating Temperature | -55°C to +85°C |
| Storage Temperature | -65°C to +150°C |

- Exceeding any one or combination of these limits may cause permanent damage to this device.
- MACOM does not recommend sustained operation near these survivability limits.
- Operating at nominal conditions with $T_J \leq +150^\circ\text{C}$ will ensure $\text{MTTF} > 1 \times 10^6$ hours.

Handling Procedures

Please observe the following precautions to avoid damage:

Static Sensitivity

These electronic devices are sensitive to electrostatic discharge (ESD) and can be damaged by static electricity. Proper ESD control techniques should be used when handling these HBM Class 1A devices.

Image-Reject Mixer

8 - 26 GHz



MAMX-011040-DIE

Rev. V1

Typical Performance Curves: 90° Hybrid @ 100 MHz IF

Down Conversion Gain (Upper Side Band) over LO Drive

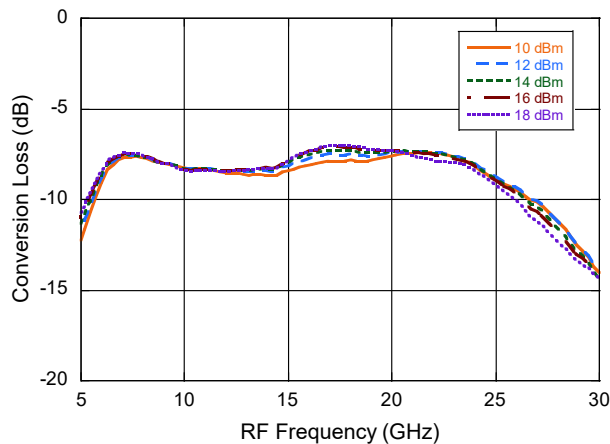

Down Conversion Image Rejection (Upper Side Band) over LO Drive

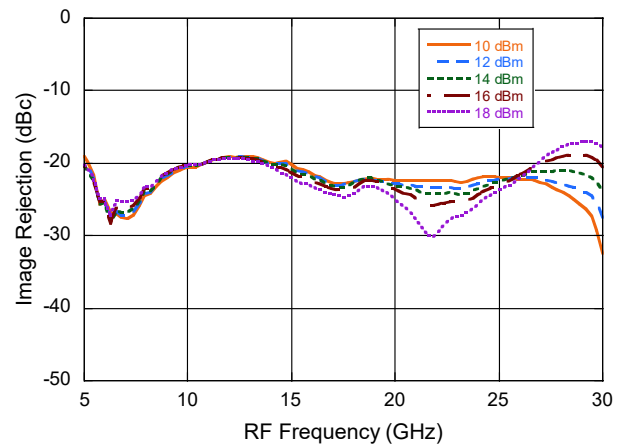

Down Conversion Gain (Upper Side Band) over Temperature

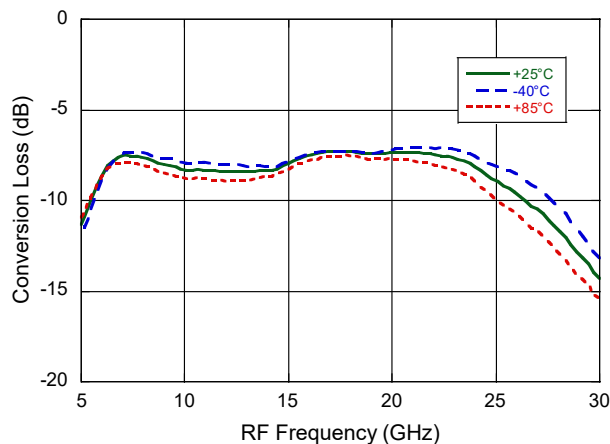

Down Conversion Image Rejection (Upper Side Band) over Temperature

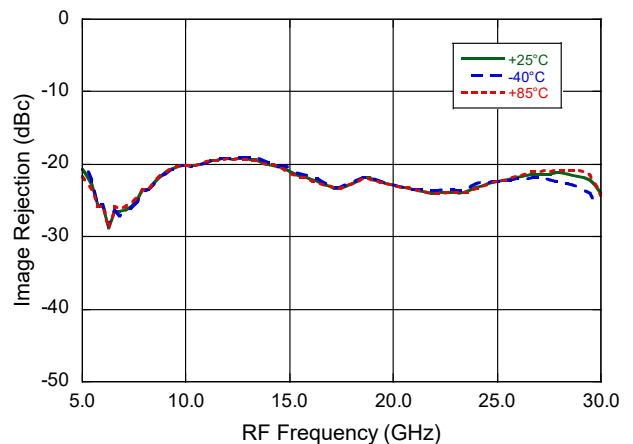

Down Conversion Gain (Lower Side Band) over LO Drive

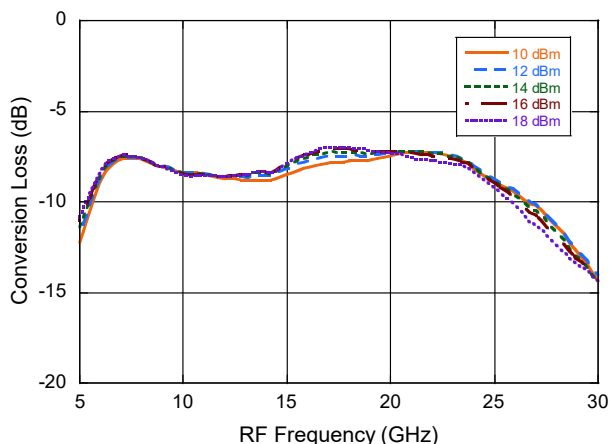

Down Conversion Image Rejection (Lower Side Band) over LO Drive

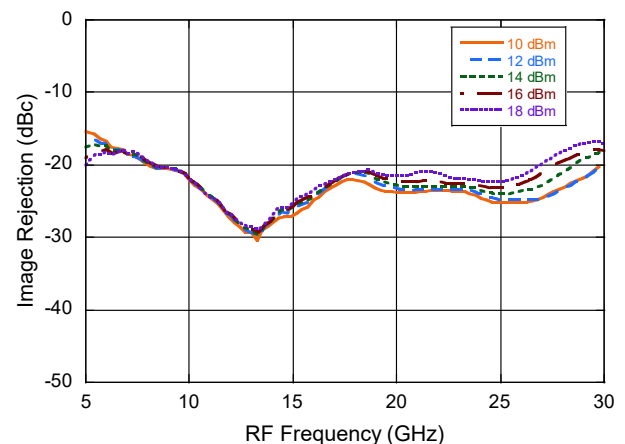

Image-Reject Mixer

8 - 26 GHz



MAMX-011040-DIE

Rev. V1

Typical Performance Curves: 90° Hybrid @ 100 MHz IF

Up Conversion Gain (USB) over LO Drive

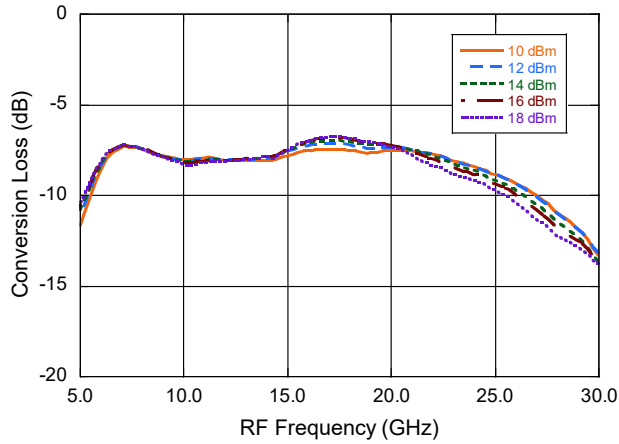

Up Conversion SSB (USB) over LO Drive

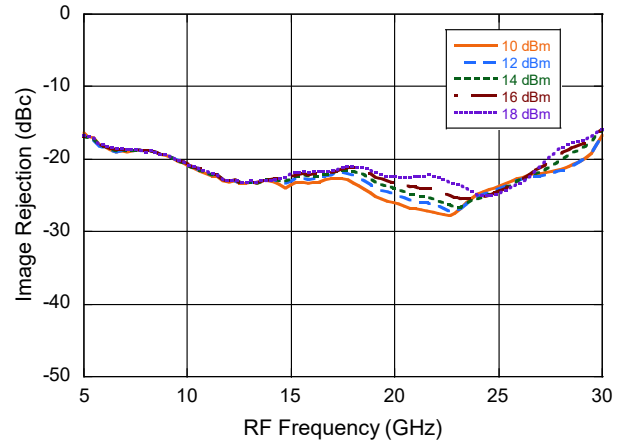

Down Conversion IIP2 (USB) over LO Drive

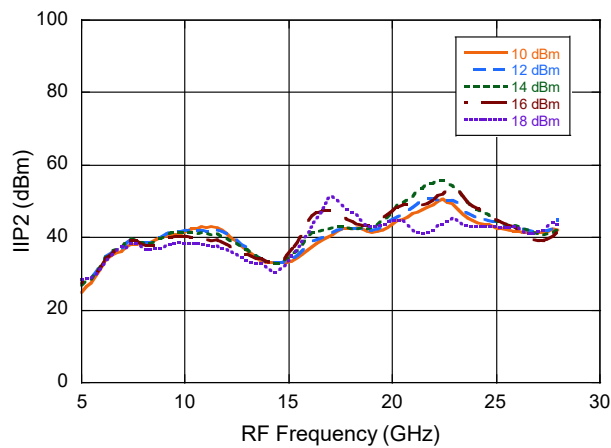

Down Conversion IIP3 (USB) over LO Drive

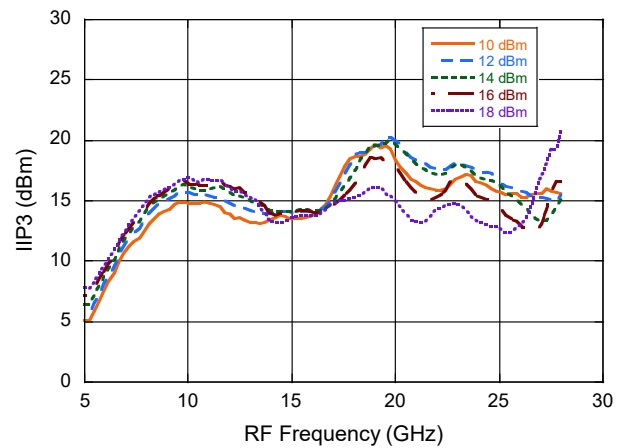

Down Conversion P1dB (USB) Over LO Drive

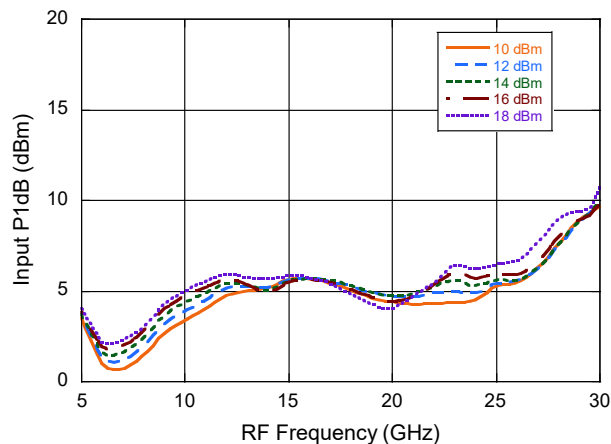

Down Conversion Isolation

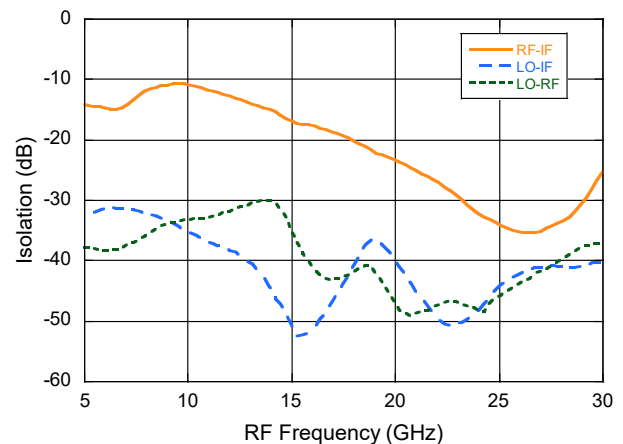

Image-Reject Mixer

8 - 26 GHz



MAMX-011040-DIE

Rev. V1

Typical Performance Curves:

Amplitude Imbalance

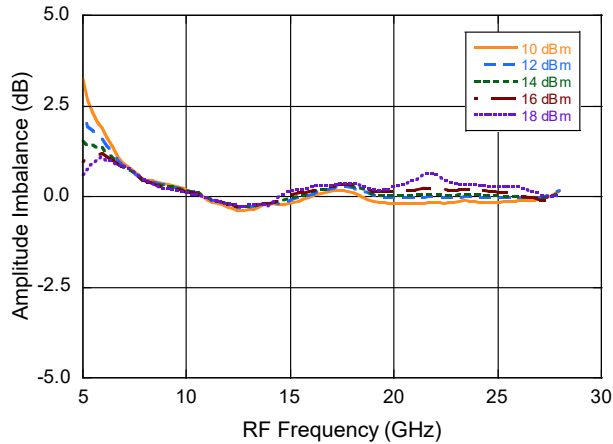

Phase Imbalance

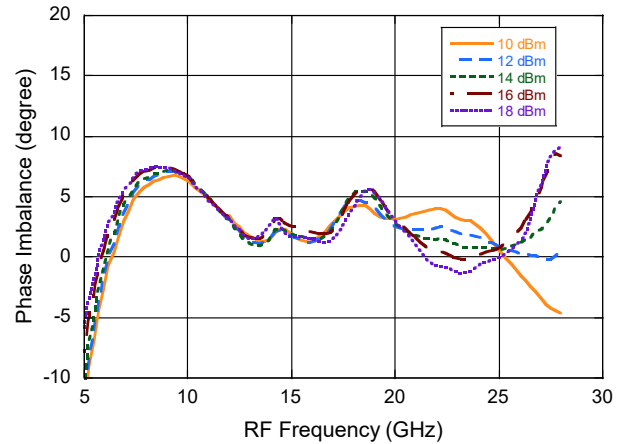

RF Return Loss

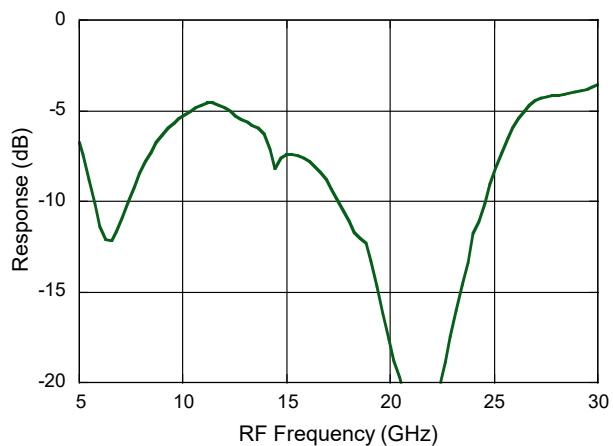

IF Return Loss

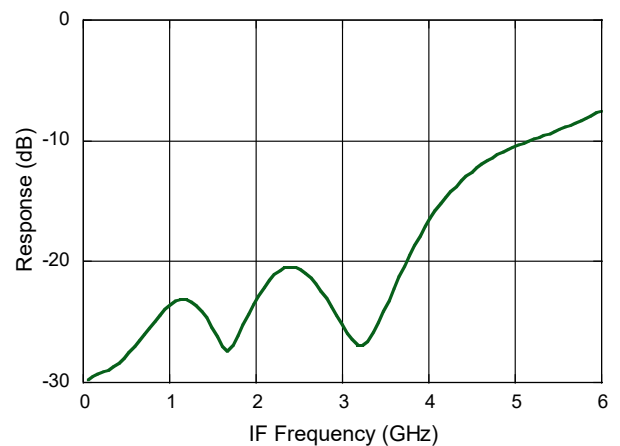

IF Bandwidth

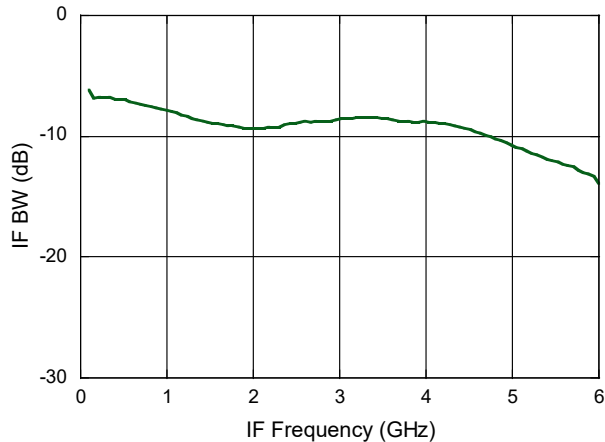

Image-Reject Mixer

8 - 26 GHz



MAMX-011040-DIE

Rev. V1

MxN Spurious Rejection @ IF Port

RF = 15.9 GHz @ -10 dBm

LO = 16 GHz @ +14 dBm

All values in dBc below, the IF output power level

| MxRF | NxLO | | | | |
|------|------|----|----|-----|----|
| | 0 | 1 | 2 | 3 | 4 |
| 0 | X | 6 | 10 | 11 | X |
| 1 | 19 | 0 | 48 | 39 | 58 |
| 2 | 76 | 92 | 51 | 63 | 63 |
| 3 | 72 | 80 | 87 | 56 | 90 |
| 4 | X | X | X | 102 | 81 |

LO Harmonics

LO = +14 dBm

All values in dBc below,
input LO level measured at RF

| LO GHz | n LO spur at RF port | | | |
|--------|----------------------|-----|-----|-----|
| | 1 | 2 | 3 | 4 |
| 6 | 51 | 50 | 62 | 52 |
| 8 | 37 | 46 | 53 | 50 |
| 10 | 36 | 50 | 60 | 45 |
| 12 | 36 | 53 | 65 | 42 |
| 14 | 30 | 47 | 44 | N/A |
| 16 | 47 | 57 | 41 | N/A |
| 18 | 47 | 56 | N/A | N/A |
| 20 | 48 | 49 | N/A | N/A |
| 22 | 45 | 50 | N/A | N/A |
| 24 | 48 | 42 | N/A | N/A |
| 26 | 51 | N/A | N/A | N/A |

Hybrid Configuration

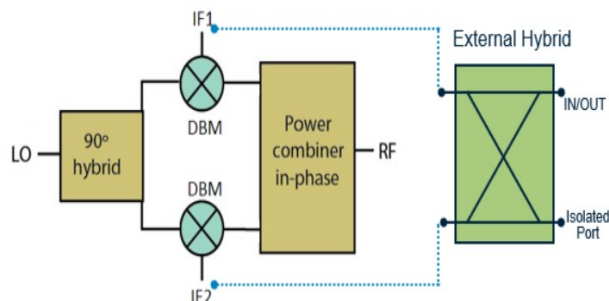

External Hybrid

- Down conversion and Up conversion data captured with external hybrid 90° coupler part number: Innovative IPP-2345.
- RF Upper Side Band (USB) mode connect hybrid 0° port to IF1 mixer port, 90° hybrid port to IF2 mixer port.
- RF Lower Side Band (LSB) mode connect hybrid 0° port to IF2 mixer port, 90° hybrid port to IF1 mixer port.

Assembly Guideline

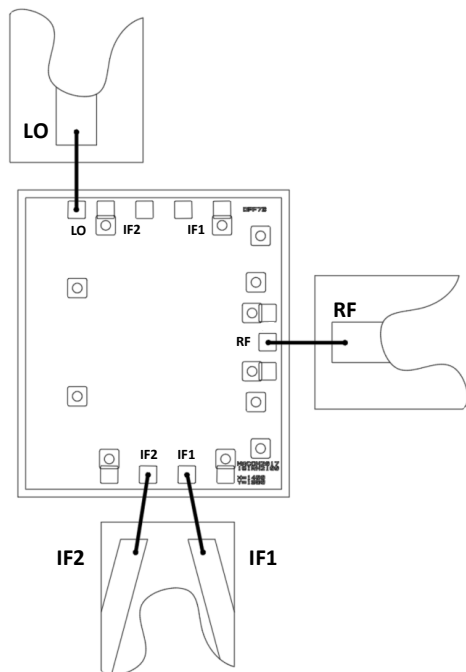

Attach bare die to PCB or carrier using conductive epoxy. Bond die signal pads to PCB 50 Ω traces using 1 mil gold wire. Single bond wire is recommended on each signal pad for optimal performance. There is no need to bond the die ground pads.

Caution: Exposed airbridges are incorporated in the circuit layout on the top surface of this die. These airbridges are sensitive in structure and due care should be taken when handling the die.

Outline Drawing

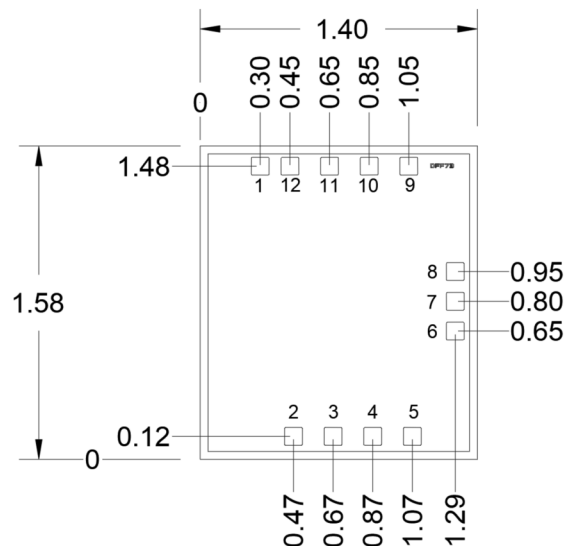

Bondpad Table (all pads are 90 x 90 μm)^{9,10}

| Pad # | Pad Name |
|--------------|----------|
| 1 | LO |
| 2,5,6,8,9,12 | GND |
| 3,10 | IF1 |
| 4,11 | IF2 |
| 7 | RF |

9. Units are in microns with a tolerance of ±5 μm, except for die exterior dimensions which are street-center-to-street-center – nominal kerf, ±20 μm tolerance.
10. Die thickness is 100 ±10 μm.

MACOM Technology Solutions Inc. ("MACOM"). All rights reserved.

These materials are provided in connection with MACOM's products as a service to its customers and may be used for informational purposes only. Except as provided in its Terms and Conditions of Sale or any separate agreement, MACOM assumes no liability or responsibility whatsoever, including for (i) errors or omissions in these materials; (ii) failure to update these materials; or (iii) conflicts or incompatibilities arising from future changes to specifications and product descriptions, which MACOM may make at any time, without notice. These materials grant no license, express or implied, to any intellectual property rights.

THESE MATERIALS ARE PROVIDED "AS IS" WITH NO WARRANTY OR LIABILITY, EXPRESS OR IMPLIED, RELATING TO SALE AND/OR USE OF MACOM PRODUCTS INCLUDING FITNESS FOR A PARTICULAR PURPOSE, MERCHANTABILITY, INFRINGEMENT OF INTELLECTUAL PROPERTY RIGHT, ACCURACY OR COMPLETENESS, OR SPECIAL, INDIRECT, INCIDENTAL, OR CONSEQUENTIAL DAMAGES WHICH MAY RESULT FROM USE OF THESE MATERIALS.

MACOM products are not intended for use in medical, lifesaving or life sustaining applications. MACOM customers using or selling MACOM products for use in such applications do so at their own risk and agree to fully indemnify MACOM for any damages resulting from such improper use or sale.