

## Double-Balanced Mixer 8 to 43 GHz

Rev. V2

### Features

- Low Conversion Loss: 8.5 dB
- High Linearity: 20 dBm IIP3
- Wide IF Bandwidth: DC to 10 GHz
- High Isolation
- Lead-Free 3 mm 12-lead AQFN package
- RoHS\* Compliant

### Description

MAMX-011036 is a double-balanced passive diode mixer housed in a 3 mm, 12-lead AQFN package. The mixer offers low conversion loss, high linearity and a wide IF bandwidth. The double-balanced circuit configuration provides excellent port isolation while internal 50-ohm matching simplifies its application.

This mixer is well suited for applications such as test and measurement, microwave radio and radar.

MAMX-011036 is also available in die form. Refer to datasheet MAMX-011036-DIE.

### Ordering Information<sup>1,2</sup>

Part Number	Package
MAMX-011036	Bulk
MAMX-011036-TR0100	100 Piece Reel
MAMX-011036-TR0500	500 Piece Reel
MAMX-011036-SB1	Sample Board

1. Reference Application Note M513 for reel size information.
2. All sample boards include 5 loose parts.

### Functional Schematic

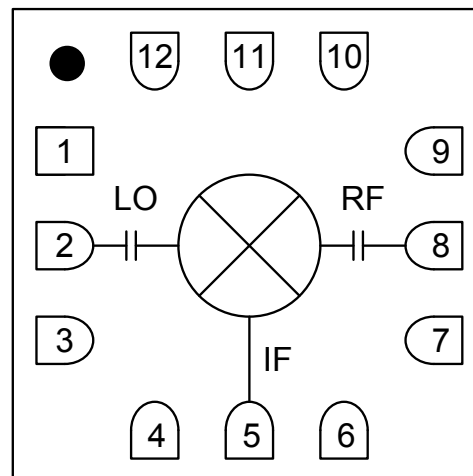

### Pin Configuration<sup>3</sup>

Pin No.	Function	Pin No.	Function
1	Ground	7	Ground
2	LO	8	RF
3	Ground	9	Ground
4	Ground	10	No Connection <sup>3</sup>
5	IF	11	No Connection <sup>3</sup>
6	Ground	12	No Connection <sup>3</sup>
		13	Paddle <sup>4</sup>

3. MACOM recommends connecting unused package pins to ground.
4. The exposed pad centered on the package bottom must be connected to RF, DC and thermal ground.

\* Restrictions on Hazardous Substances, European Union Directive 2011/65/EU.

## Double-Balanced Mixer 8 to 43 GHz

Rev. V2

**Electrical Specifications<sup>5</sup>:**  $F_{IF} = 500 \text{ MHz}$ ,  $P_{LO} = +15 \text{ dBm}$ ,  $T_A = 25^\circ\text{C}$ ,  $Z_0 = 50 \Omega$

Parameter	Test Conditions	Units	Min.	Typ.	Max.
LO and RF Frequency	—	GHz	8	—	43
IF Frequency	—	GHz	0	—	10
LO Power	—	dBm	—	15	—
Conversion Loss	8 - 20 GHz 20 - 34 GHz 34 - 43 GHz	dB	—	8.5 8.5 9.5	10 10.5 13
Input P1dB	—	dBm	—	13	—
Input IP3	$P_{RF} = -10 \text{ dBm/tone}$ , $\Delta f = 1 \text{ MHz}$	dBm	—	20	—
Input IP2	$P_{RF} = -10 \text{ dBm/tone}$ , $\Delta f = 1 \text{ MHz}$	dBm	—	45	—
LO-to-RF Isolation	—	dB	—	40	—
LO-to-IF Isolation	8 - 20 GHz 20 - 34 GHz 34 - 43 GHz	dB	30 25 25	40 35 40	—
RF-to-IF Isolation	8 - 20 GHz 20 - 34 GHz 34 - 43 GHz	dB	8 15 17	9 25 35	—
RF Return Loss	RF = 25 GHz	dB	—	7	—
IF Return Loss	IF = 500 MHz	dB	—	12	—

5. All specifications refer to down-conversion operation, unless otherwise noted.

### Absolute Maximum Ratings<sup>6,7</sup>

Parameter	Absolute Maximum
LO Power	23 dBm
RF or IF Power	20 dBm
Junction Temperature <sup>8</sup>	+150°C
Operating Temperature	-55°C to +85°C
Storage Temperature	-65°C to +150°C

- Exceeding any one or combination of these limits may cause permanent damage to this device.
- MACOM does not recommend sustained operation near these survivability limits.
- Operating at nominal conditions with  $T_J \leq +150^\circ\text{C}$  will ensure  $\text{MTTF} > 1 \times 10^6$  hours.

### Handling Procedures

Please observe the following precautions to avoid damage:

### Static Sensitivity

These electronic devices are sensitive to electrostatic discharge (ESD) and can be damaged by static electricity. Proper ESD control techniques should be used when handling these devices with the following rating:

HBM Class 1B  
CDM Class C3

## Typical Performance Curves

**Conversion Gain vs. LO Drive**

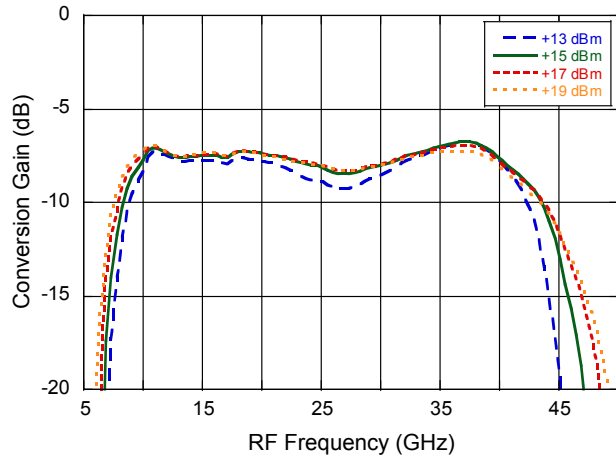

**Conversion Gain vs. Temperature**

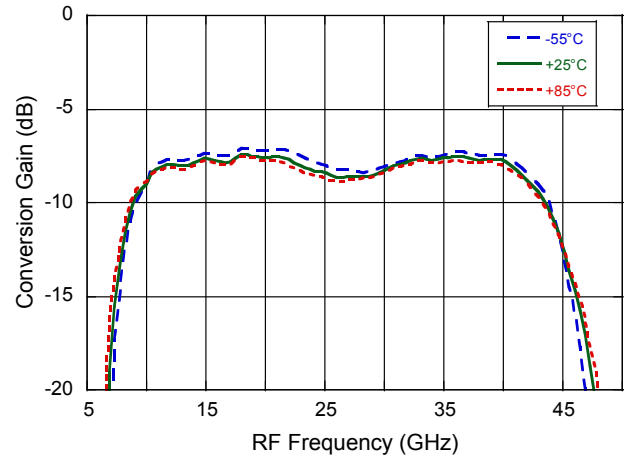

**Isolation**

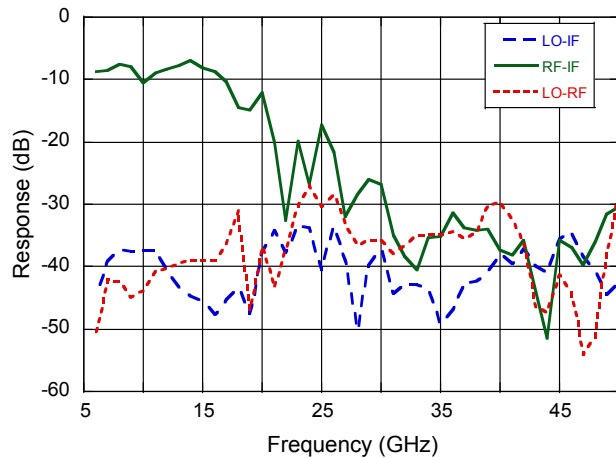

**RF Return Loss**

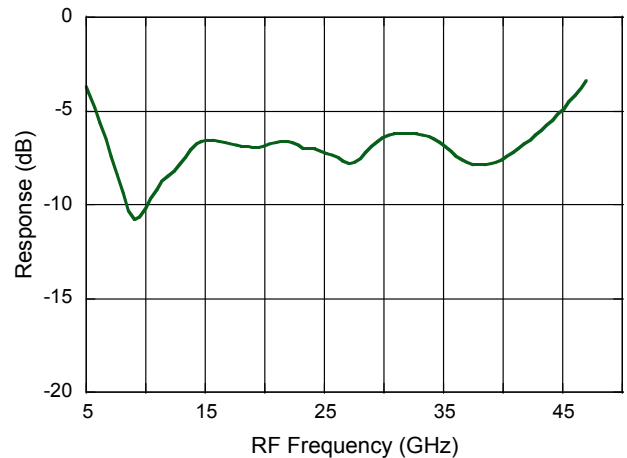

**IF Bandwidth**

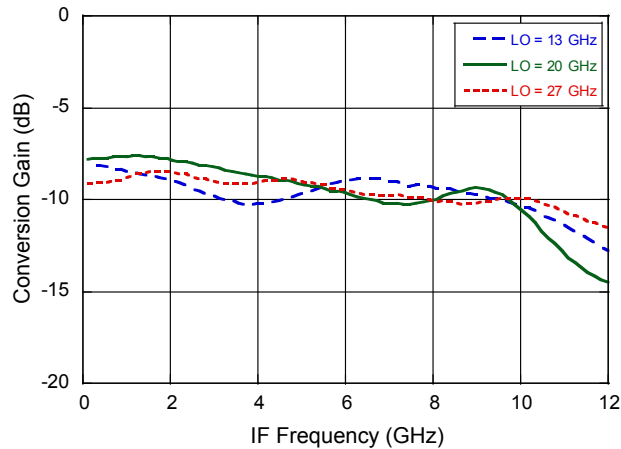

**IF Return Loss**

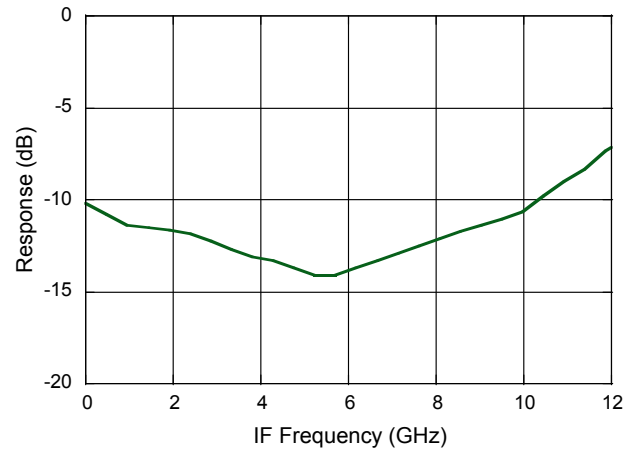

## Typical Performance Curves

**Input IP3 vs. LO Drive**

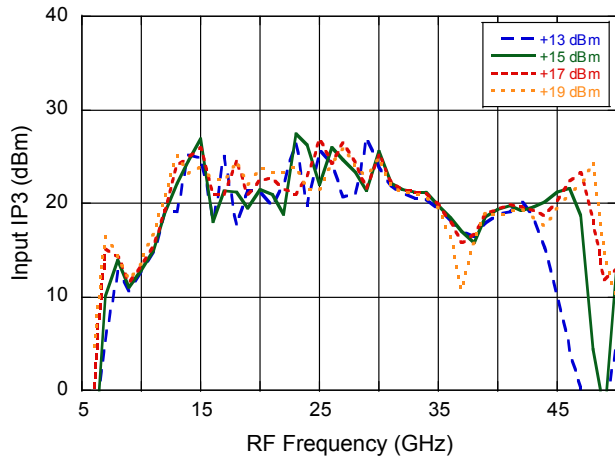

**Input IP3 vs. Temperature**

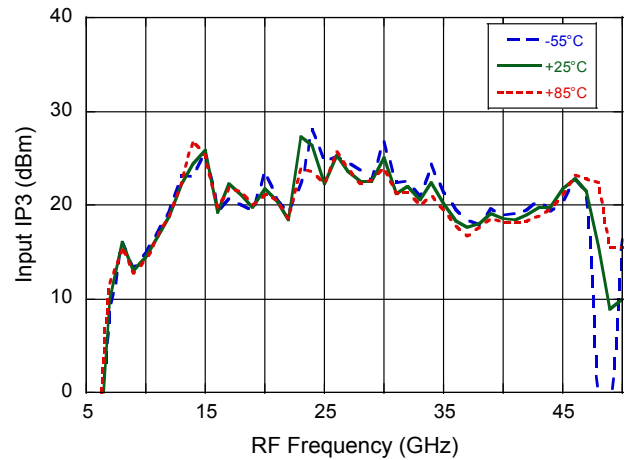

**Input IP2 vs. LO Drive**

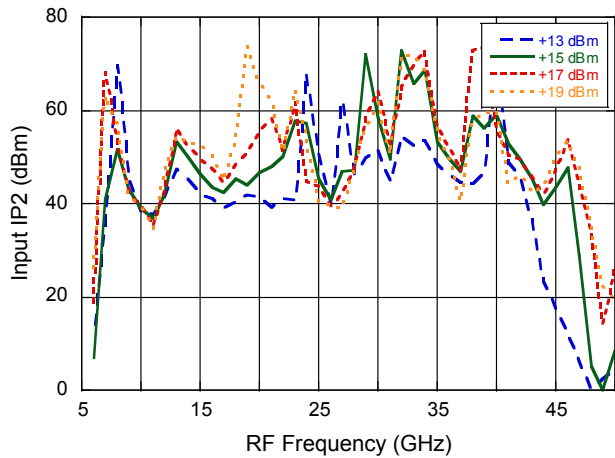

**Input IP2 vs. Temperature**

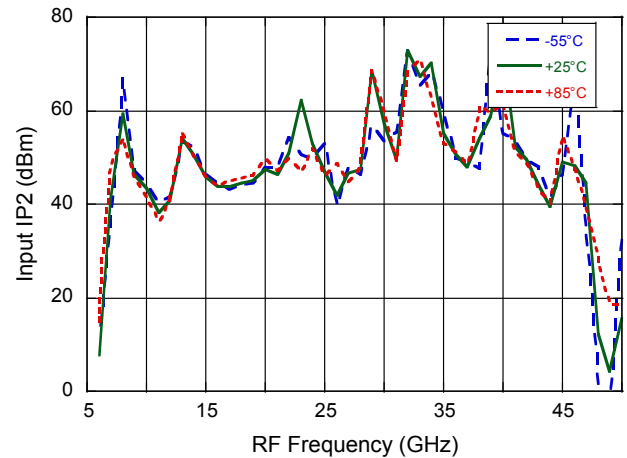

**Input P1dB vs. LO Drive**

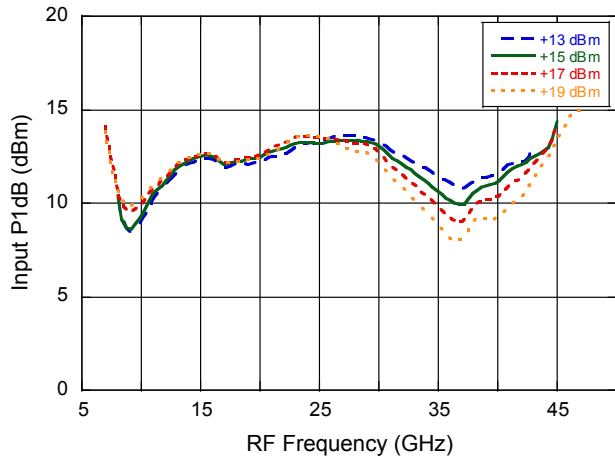

**Up Conversion Gain vs. LO Drive**

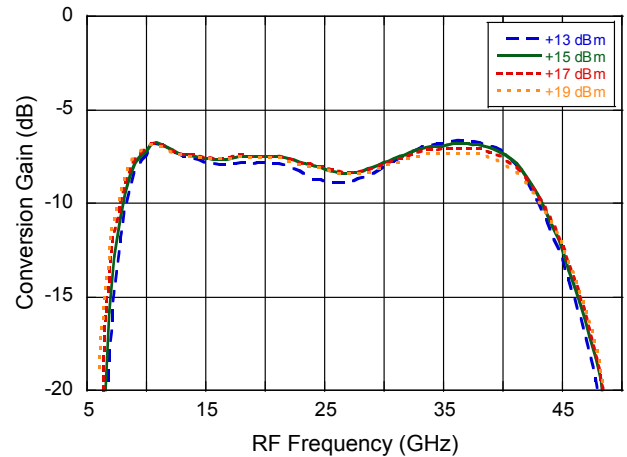

## Double-Balanced Mixer 8 to 43 GHz

Rev. V2

### MxN Spurious Rejection at IF Port (dBc IF)

RF = 17.5 GHz at -10 dBm

LO = 18.0 GHz at +15 dBm

MxRF	NxLO				
	0	1	2	3	4
0	x	17	30	x	x
1	3	0	28	41	x
2	60	67	59	68	61
3	x	64	72	76	69
4	x	x	63	71	81

### PCB Layout

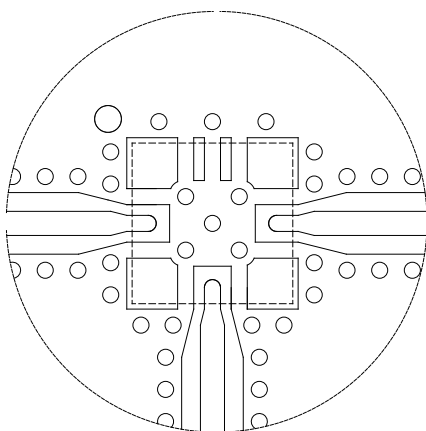

DXF available on request based on 10mil RO4350 substrate.

### Application Schematic

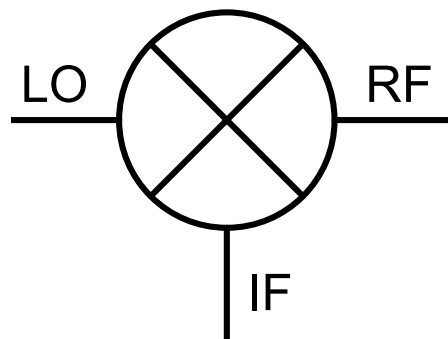

No external parts required for operation of MAMX-011036.

## Double-Balanced Mixer 8 to 43 GHz

Rev. V2

### Lead-Free 3 mm 12-Lead AQFN<sup>†</sup>

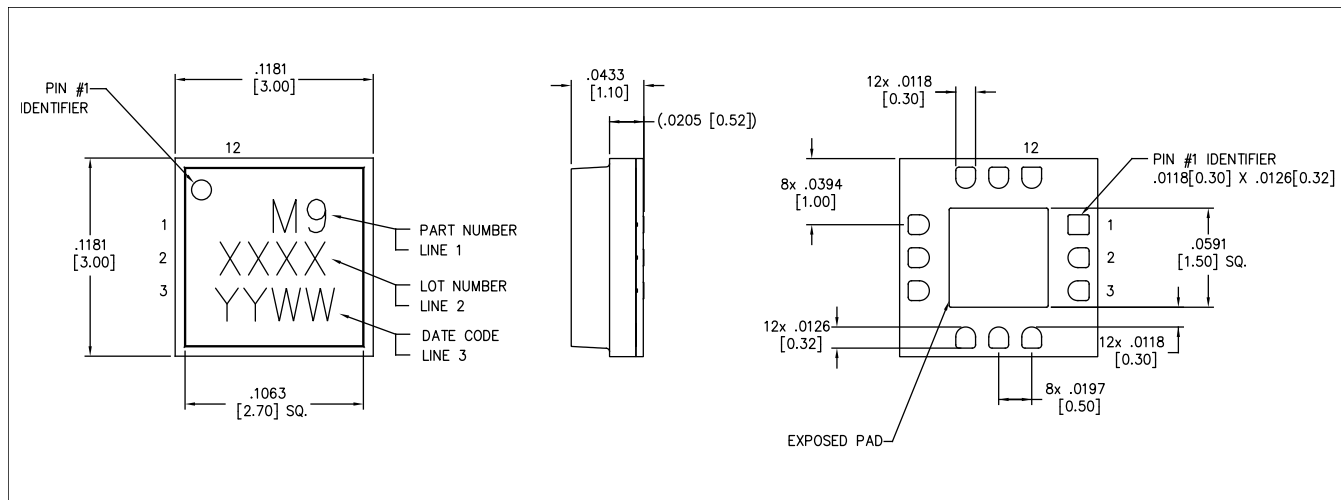

<sup>†</sup> Reference Application Note S2083 for lead-free solder reflow recommendations.  
 Meets JEDEC moisture sensitivity level 3 requirements.  
 Plating is NiPdAu.  
 All dimensions are inches [mm].

MACOM Technology Solutions Inc. All rights reserved.

Information in this document is provided in connection with MACOM Technology Solutions Inc ("MACOM") products. These materials are provided by MACOM as a service to its customers and may be used for informational purposes only. Except as provided in MACOM's Terms and Conditions of Sale for such products or in any separate agreement related to this document, MACOM assumes no liability whatsoever. MACOM assumes no responsibility for errors or omissions in these materials. MACOM may make changes to specifications and product descriptions at any time, without notice. MACOM makes no commitment to update the information and shall have no responsibility whatsoever for conflicts or incompatibilities arising from future changes to its specifications and product descriptions. No license, express or implied, by estoppel or otherwise, to any intellectual property rights is granted by this document.

THESE MATERIALS ARE PROVIDED "AS IS" WITHOUT WARRANTY OF ANY KIND, EITHER EXPRESS OR IMPLIED, RELATING TO SALE AND/OR USE OF MACOM PRODUCTS INCLUDING LIABILITY OR WARRANTIES RELATING TO FITNESS FOR A PARTICULAR PURPOSE, CONSEQUENTIAL OR INCIDENTAL DAMAGES, MERCHANTABILITY, OR INFRINGEMENT OF ANY PATENT, COPYRIGHT OR OTHER INTELLECTUAL PROPERTY RIGHT. MACOM FURTHER DOES NOT WARRANT THE ACCURACY OR COMPLETENESS OF THE INFORMATION, TEXT, GRAPHICS OR OTHER ITEMS CONTAINED WITHIN THESE MATERIALS. MACOM SHALL NOT BE LIABLE FOR ANY SPECIAL, INDIRECT, INCIDENTAL, OR CONSEQUENTIAL DAMAGES, INCLUDING WITHOUT LIMITATION, LOST REVENUES OR LOST PROFITS, WHICH MAY RESULT FROM THE USE OF THESE MATERIALS.

MACOM products are not intended for use in medical, lifesaving or life sustaining applications. MACOM customers using or selling MACOM products for use in such applications do so at their own risk and agree to fully indemnify MACOM for any damages resulting from such improper use or sale.