

### Features

- 2-Stage LNA and High Power Switch
- Bypass Switch on Second LNA Stage
- High RF Input Power:  
160 W CW @ +105°C, 2.6 GHz
- Noise Figure:  
1.2 dB @ 2.6 GHz  
1.5 dB @ 3.5 GHz  
1.8 dB @ 4.5 GHz
- Gain, High Gain Mode:  
34 dB @ 2.6 GHz  
33 dB @ 3.5 GHz  
32 dB @ 4.5 GHz
- Output IP3: 35 dBm (High Gain Mode)
- Lead-Free 5 mm 32-lead HQFN
- Integrated ESD Protection
- RoHS\* Compliant

### Applications

- High Power TDD 4G & 5G Basestation
- Wireless Infrastructure
- TDD-based Communication System

### Description

The MAMF-011139 is a compact surface mount module containing a PIN diode switch and two low noise amplifiers assembled in a 5 mm 32-lead HQFN plastic package.

Some DC bias and matching SMT components are required for PIN switch operation and optimized noise figure. The second LNA, LNA2, may be bypassed through an integrated switch. LNA2 is powered down when bypassed.

### Ordering Information<sup>1,2</sup>

Part Number	Package
MAMF-011139-TR1000	1K Reel
MAMF-011139-001SMB	Sample Board

1. Reference Application Note M513 for reel size information.
2. All sample boards include 3 loose parts.

### Functional Schematic

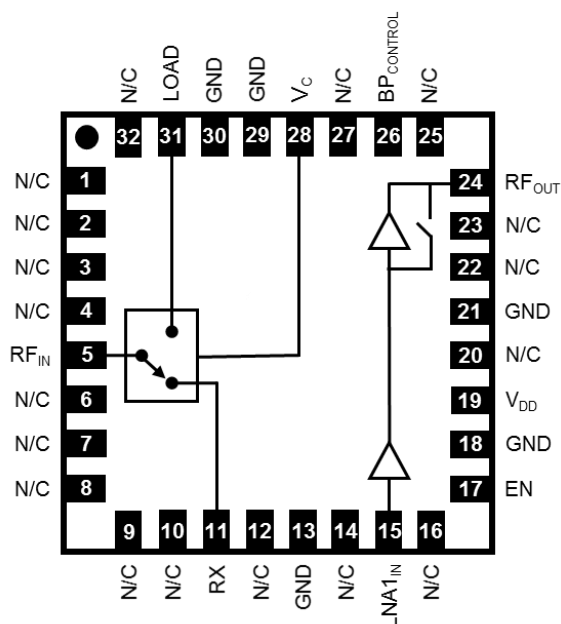

### Pin Configuration<sup>3,4</sup>

Pin #	Pin Name	Description
1-4, 6-10, 12, 14, 16, 20, 22, 23, 25, 27, 32	N/C <sup>3</sup>	No Connection
5	RF <sub>IN</sub>	Common RF Input / Bias
11	RX	RX Switch Output
13, 18, 21, 29, 30	GND	RF Ground
15	LNA1 <sub>IN</sub>	LNA1 Input
17	EN	LNA1/2 Enable
19	V <sub>DD</sub>	Drain Supply
24	RF <sub>OUT</sub>	LNA2 Output
26	BP <sub>CONTROL</sub>	Bypass Switch Control
28	V <sub>C</sub>	RX/TX Switch Control
31	LOAD	TX Switch Output

3. MACOM recommends connecting unused package pins to ground.
4. The exposed pad centered on the package bottom must be connected to RF, DC and thermal ground.

\* Restrictions on Hazardous Substances, compliant to current RoHS EU directive.

# High Power Switch - LNA Module with Bypass

## 1.4 - 6.0 GHz



MAMF-011139

Rev. V1

**Electrical Specifications:  $T_A = +25^\circ\text{C}$ ,  $V_{DD} = 5\text{ V}$ ,  $BP_{\text{CONTROL}} = 3.3\text{ V}$ ,  $EN = 0\text{ V}$**

**See RX/TX Switch Bias Table**

Parameter	Test Conditions	Units	Min.	Typ.	Max.
Input RF Power @ +105°C RF <sub>IN</sub> - LOAD 200 mA Bias Current	2.6 GHz 3.5 GHz 4.5 GHz	W	—	160 140 125	—
Input RF Power @ +105°C RF <sub>IN</sub> - LOAD 100 mA Bias Current	2.6 GHz 3.5 GHz 4.5 GHz	W	—	120 105 95	—
Switch Insertion Loss RF <sub>IN</sub> - LOAD	2.6 GHz 3.5 GHz 4.5 GHz	dB	—	0.3 0.4 0.6	— 0.7 —
Noise Figure in Both Modes RF <sub>IN</sub> - RF <sub>OUT</sub>	2.6 GHz 3.5 GHz 4.5 GHz	dB	—	1.2 1.5 1.8	— 1.9 —
Input Return Loss in Both Modes RF <sub>IN</sub> - RF <sub>OUT</sub>	2.6 GHz 3.5 GHz 4.5 GHz	dB	—	12 22 12	—
Output Return Loss in Both Modes RF <sub>IN</sub> - RF <sub>OUT</sub>	2.6 GHz HG / LG 3.5 GHz HG / LG 4.5 GHz HG / LG	dB	—	10/17 15/13 15/17	—
Gain in High Gain Mode RF <sub>IN</sub> - RF <sub>OUT</sub>	2.6 GHz 3.5 GHz 4.5 GHz	dB	— 29.5 —	34.1 32.5 32.0	—
Gain in Low Gain Mode RF <sub>IN</sub> - RF <sub>OUT</sub>	2.6 GHz 3.5 GHz 4.5 GHz	dB	— 17 —	20.1 19.3 18.0	—
Isolation RF <sub>IN</sub> - LNA1 <sub>IN</sub>	Switch State = RF <sub>IN</sub> - LOAD 2.6 GHz 3.5 GHz 4.5 GHz	dB	—	46 47 45	—
Output IP3 in High Gain Mode RF <sub>IN</sub> - RF <sub>OUT</sub>	P <sub>OUT</sub> = +10 dBm per tone, 11 MHz spacing	dBm	—	35	—
Output IP3 in Low Gain Mode RF <sub>IN</sub> - RF <sub>OUT</sub>	P <sub>OUT</sub> = +3 dBm per tone, 11 MHz spacing	dBm	—	29.5	—
Output P1dB in High Gain Mode	RF <sub>IN</sub> - RF <sub>OUT</sub>	dBm	—	19	—
Output P1dB in Low Gain Mode	RF <sub>IN</sub> - RF <sub>OUT</sub>	dBm	—	15.3	—
V <sub>DD</sub> Bias Current	High Gain Mode Low Gain Mode	mA	—	108 44	—
Control Voltage	Logic High Logic Low	V	1.2 0	—	3.45 0.6
Logic Input Current	Logic High Logic Low	μA	— —	60 0.01	— —

### RX/TX Switch Bias Table

RF <sub>IN</sub> - LOAD	RF <sub>IN</sub> - RF <sub>OUT</sub>	LOAD	RX	V <sub>c</sub>	RF <sub>IN</sub>
ON	OFF	0 V (-100 mA)	+48 V (10 mA)	0 V (-10 mA)	5 V (100 mA)
OFF	ON	+48 V (0 mA)	0 V (-100 mA)	+48 V (0 mA)	5 V (100 mA)

### LNA Logic Truth Table<sup>5</sup>

Mode	EN	BP <sub>CONTROL</sub>	Note
High Gain mode	Low	Low	LNA1 and LNA2 ON, Bypass Switch OFF
Low Gain mode	Low	High	LNA1 ON, LNA2 OFF, Bypass Switch ON
High Isolation mode	High	Low	LNA1 and LNA2 OFF, Bypass Switch OFF
Low Isolation mode	High	High	LNA1 and LNA2 OFF, Bypass Switch ON

5. If V<sub>DD</sub> pin is used to turn the LNAs ON and OFF, the logic pins need to stay at Logic Low during V<sub>DD</sub> ramp up and ramp down.

### Absolute Maximum Ratings<sup>6,7,8</sup>

Parameter	Absolute Maximum
RF Input Power RF <sub>IN</sub> - RX LNA1 <sub>IN</sub> - RF <sub>OUT</sub> RF <sub>IN</sub> - LOAD	49 dBm @ 85°C 19 dBm See Power Derating Curves
Switch Reverse Voltage (RF & DC)	160 V
Control Voltage	Lower of 3.6 V and V <sub>DD</sub> +0.5 V
V <sub>DD</sub>	5.5 V
Junction Temperature Switch LNA <sup>9</sup>	+175°C +150°C
Case (Paddle) Temperature	-40°C to +120°C
Storage Temperature	-55°C to +150°C

6. Exceeding any one or combination of these limits may cause permanent damage to this device.

7. MACOM does not recommend sustained operation near these survivability limits.

8. Operating at nominal conditions with T<sub>J</sub> ≤ +150°C (LNA) and T<sub>J</sub> ≤ +175°C (Switch) will ensure MTTF >> 1 x 10<sup>6</sup> hours.

9. LNA Junction Temperature (T<sub>J</sub>) = T<sub>C</sub> + θ<sub>JC</sub>\*(P<sub>DISS</sub>) where P<sub>DISS</sub> is the total DC & RF dissipated power.

- LNA: Typical thermal resistance (θ<sub>JC</sub>) = 33.4 °C/W.

### Handling Procedures

Please observe the following precautions to avoid damage:

### Static Sensitivity

These electronic devices are sensitive to electrostatic discharge (ESD) and can be damaged by static electricity.

Parameter	Rating	Standard
Human Body Model (HBM)	Class 1B	ESDA/JEDEC JS-001
Charged Device Model (CDM)	Class C3	ESDA/JEDEC JS-002

**Typical Performance Curves**

$V_{DD} = 5\text{ V}$ ,  $T_C = +25^\circ\text{C}$ ,  $Z_0 = 50\ \Omega$  (unless otherwise indicated)

**ANT to LOAD Input Power Derating Curve @ 2.7GHz**

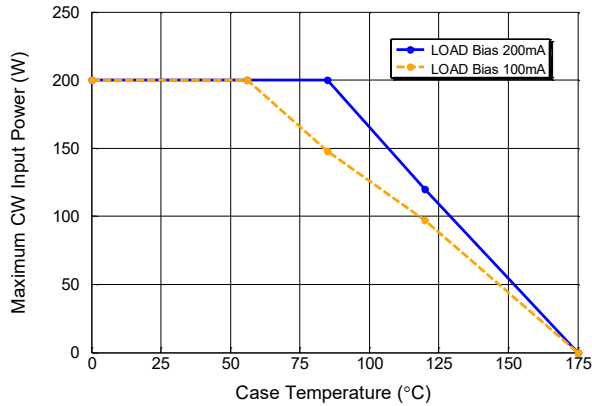

**ANT to LOAD Input Power Derating Curve over Frequency @ 85°C Case Temp**

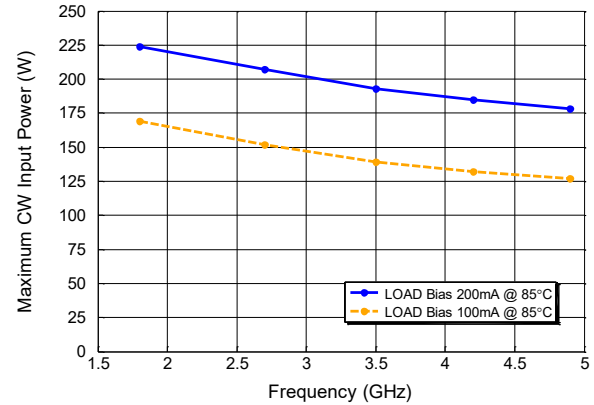

**ANT to LOAD Input Power Derating Curve over Frequency @ 105°C Case Temp**

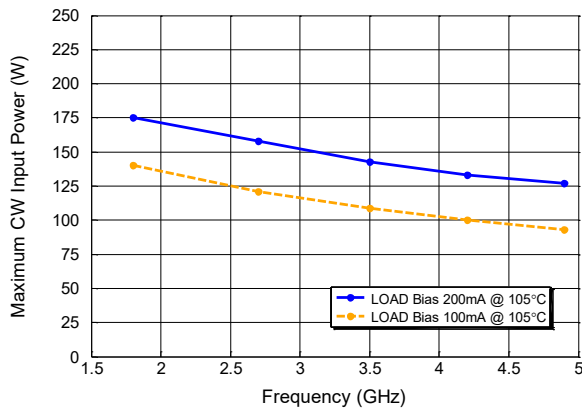

**ANT to LOAD Input Power Derating Curve over Frequency @ 120°C Case Temp**

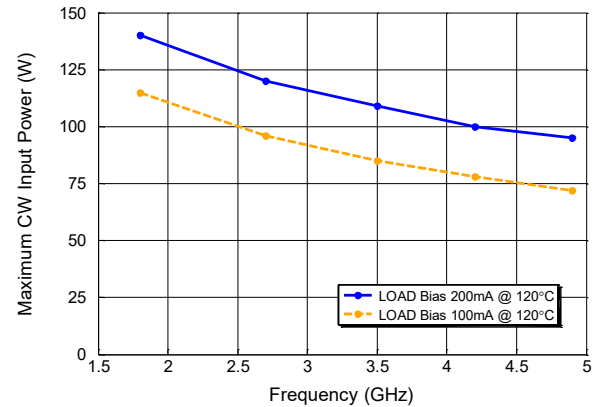

**ANT to LOAD Input Power Derating Curve over Reverse Bias Voltage @ 2.7GHz**

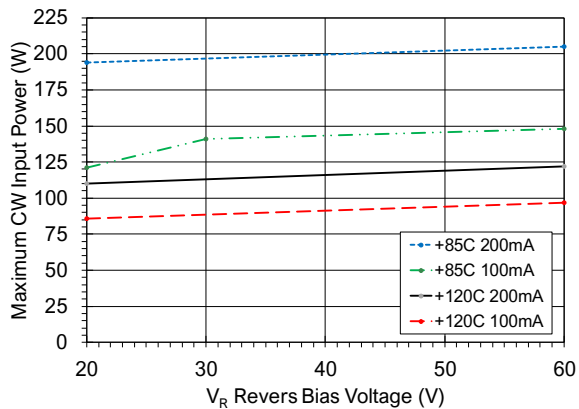

# High Power Switch - LNA Module with Bypass

## 1.4 - 6.0 GHz



MAMF-011139

Rev. V1

### PCB Layout

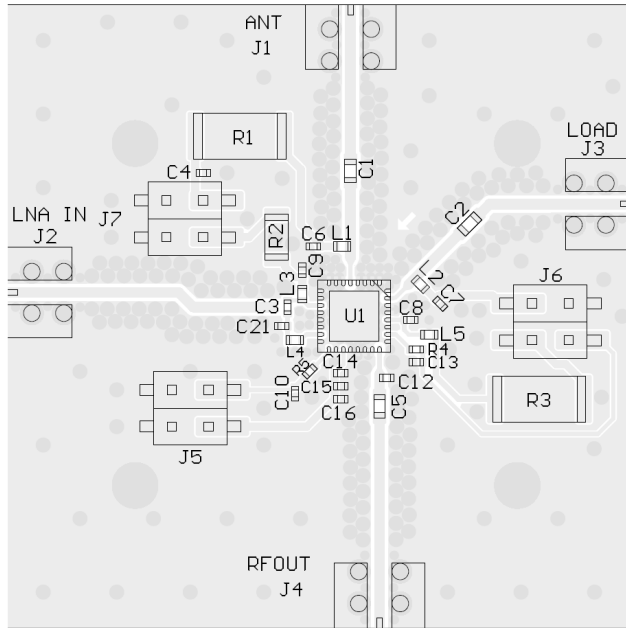

### Parts List

Part	Value	Case Style (Min Rating)
C1,C2	6.8 pF	0603 ( $\geq 250V$ )
C3	10 pF	0402 ( $\geq 100V$ )
C5	15 pF	0603
C4,C14	0.1 $\mu F$	0402
C6,C7,C8,C9	15 pF	0402 ( $\geq 100V$ )
C10	4.7 pF	0402
C12,C13,C15,C16	DNP	0402
C21	0.4 pF	0402
L1,L2,L3,L5	33 nH	0402
L4	Jumper	0402
R1	40.2 $\Omega$	2512 ( $\geq 1W$ )
R2	0 $\Omega$	1206
R3	4.7 k $\Omega$	2512 ( $\geq 1W$ )
R4	0 $\Omega$	0402
R5	100 $\Omega$	0402

### Application Schematic

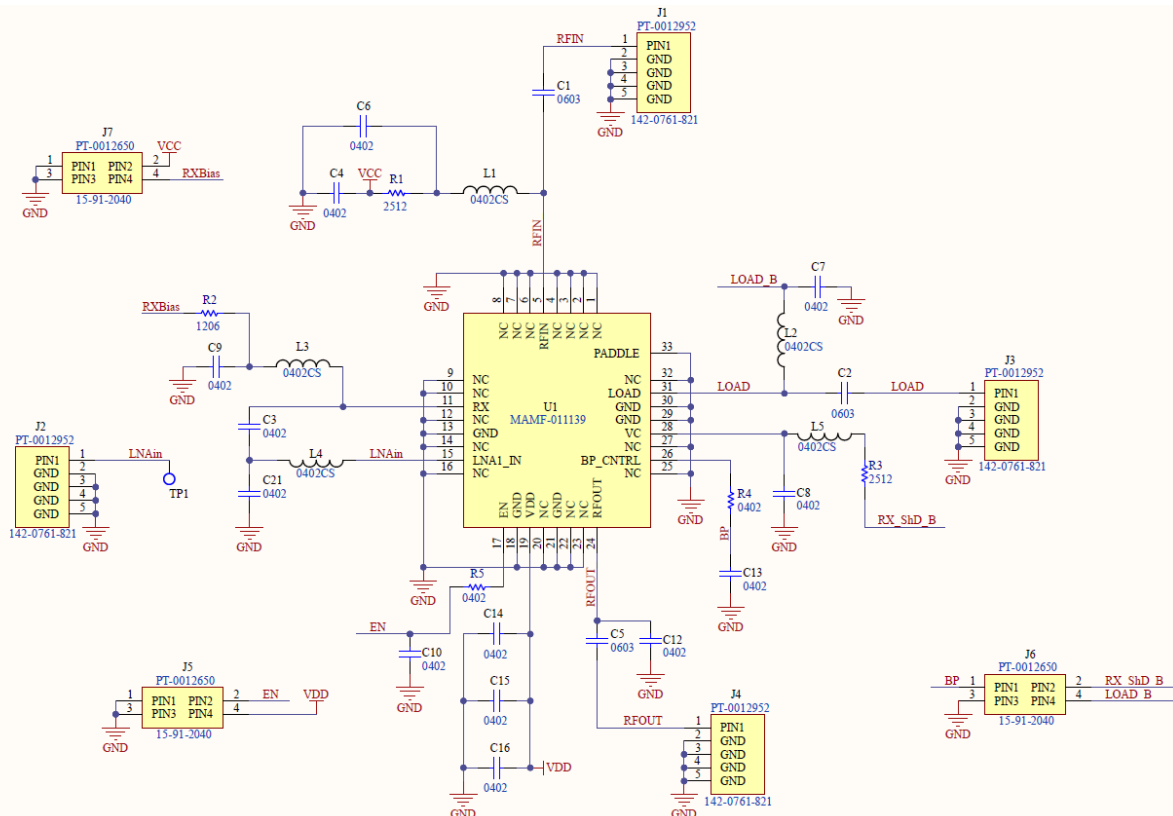

**Typical Performance Curves**

$P_{IN} = -35 \text{ dBm}$ ,  $V_{DD} = 5 \text{ V}$ ,  $T_C = +25^\circ\text{C}$ ,  $Z_0 = 50 \Omega$  (unless otherwise indicated)

**LNA Gain over swept Frequency (& Temp.) in High Gain Mode**

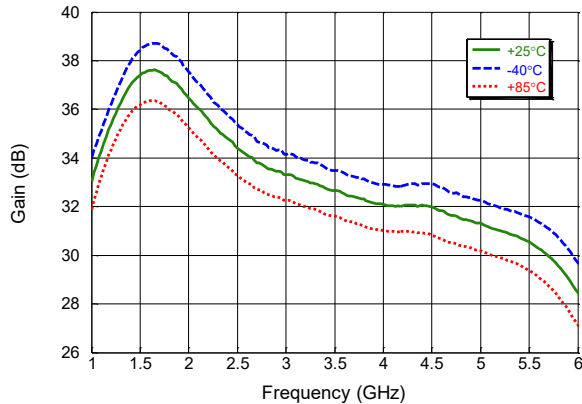

**LNA Gain over swept Frequency (& Temp.) in Low Gain Mode**

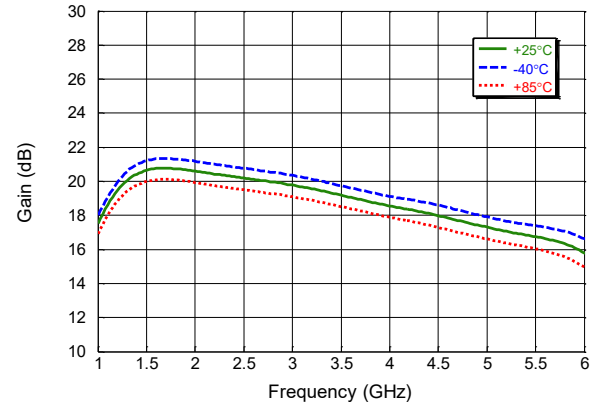

**RF<sub>IN</sub> Port Return Loss over swept Frequency (& Temp.) in High Gain Mode**

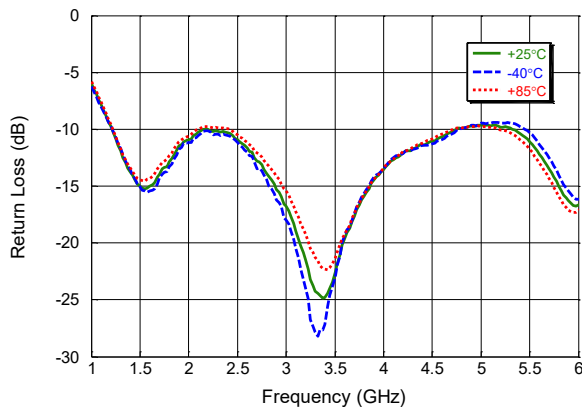

**RF<sub>IN</sub> Port Return Loss over swept Frequency (& Temp.) in Low Gain Mode**

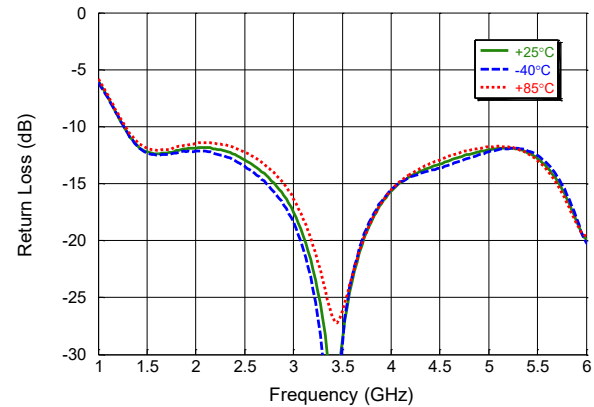

**RF<sub>OUT</sub> Port Return Loss over swept Frequency (& Temp.) in High Gain Mode**

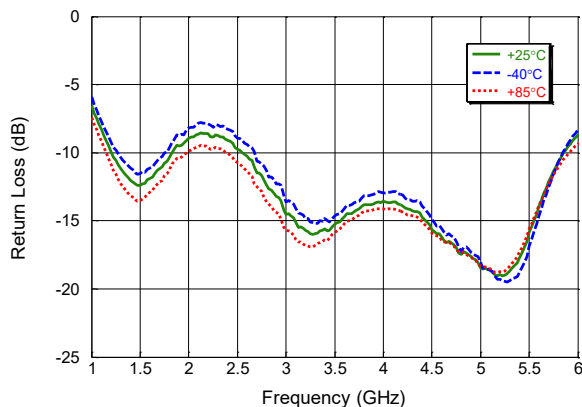

**RF<sub>OUT</sub> Port Return Loss over swept Frequency (& Temp.) in Low Gain Mode**

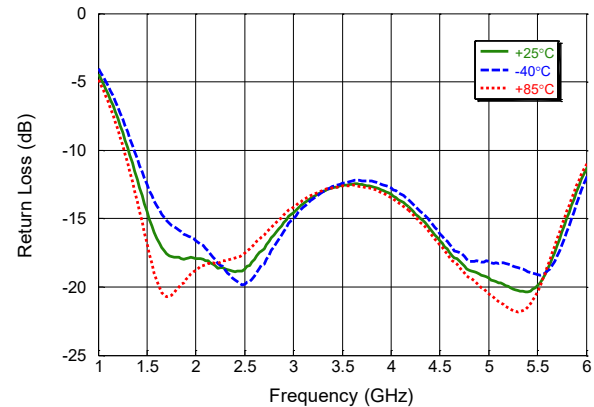

**Typical Performance Curves**

$P_{IN} = -35 \text{ dBm}$ ,  $V_{DD} = 5 \text{ V}$ ,  $T_C = +25^\circ\text{C}$ ,  $Z_0 = 50 \Omega$  (unless otherwise indicated)

**LNA Noise Figure over swept Frequency (& Temp.) in High Gain Mode**

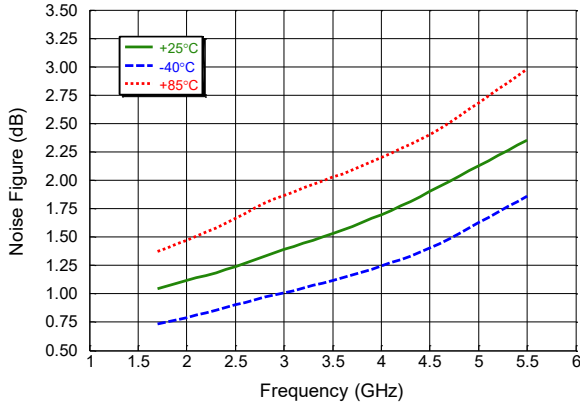

**LNA Noise Figure over swept Frequency (& Temp.) in Low Gain Mode**

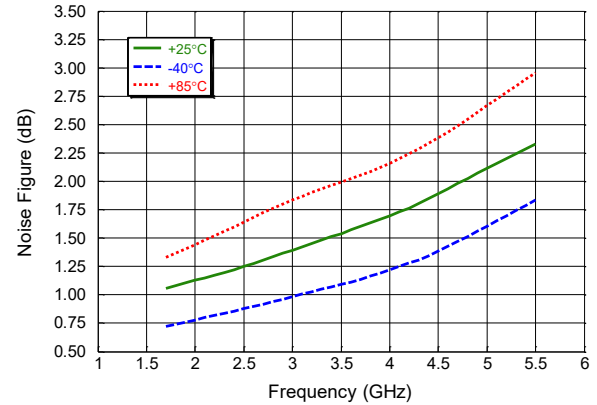

**LNA<sub>1IN</sub> to RF<sub>OUT</sub> Isolation over swept Frequency (& Temp.) in High Gain Mode**

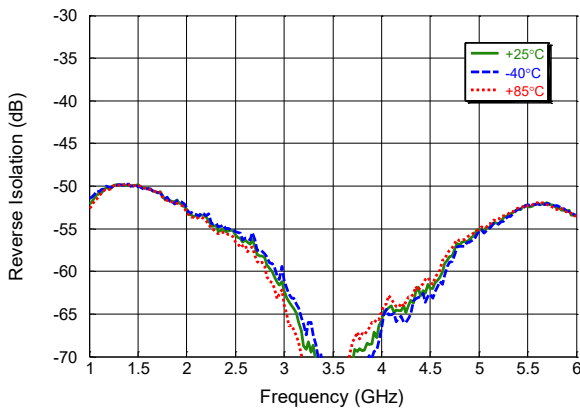

**LNA<sub>1IN</sub> to RF<sub>OUT</sub> Isolation over swept Frequency (& Temp.) in Low Gain Mode**

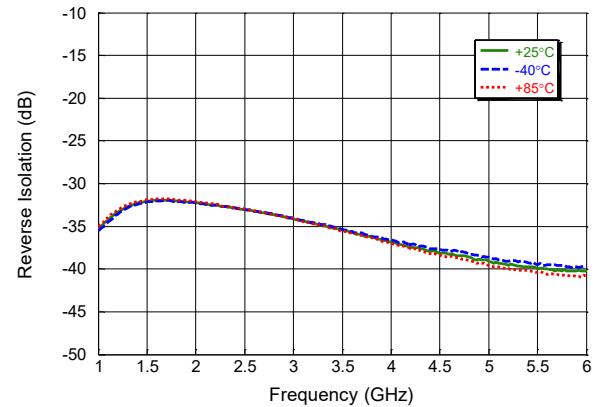

**RF<sub>IN</sub> to LNA<sub>1IN</sub> Isolation over swept Frequency (& Temp.)**

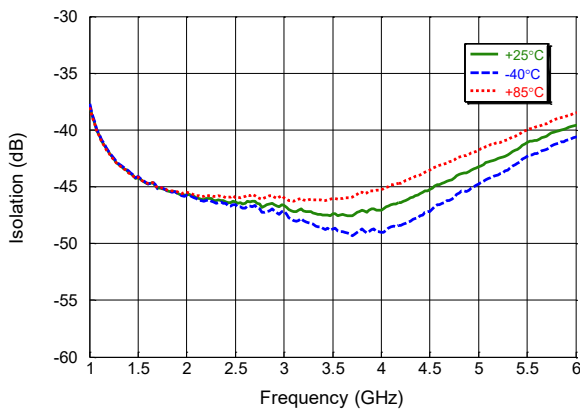

**Typical Performance Curves**

$P_{IN} = -35 \text{ dBm}$ ,  $V_{DD} = 5 \text{ V}$ ,  $T_C = +25^\circ\text{C}$ ,  $Z_0 = 50 \Omega$  (unless otherwise indicated)

**LNA Gain over swept Output Power (& Temp.) at 3.5 GHz in High Gain Mode**

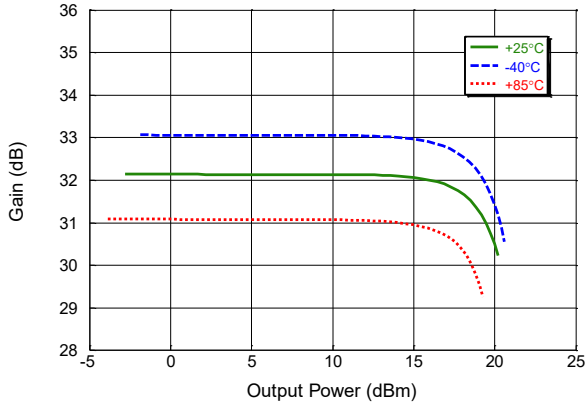

**LNA Gain over swept Output Power (& Temp.) at 3.5 GHz in Low Gain Mode**

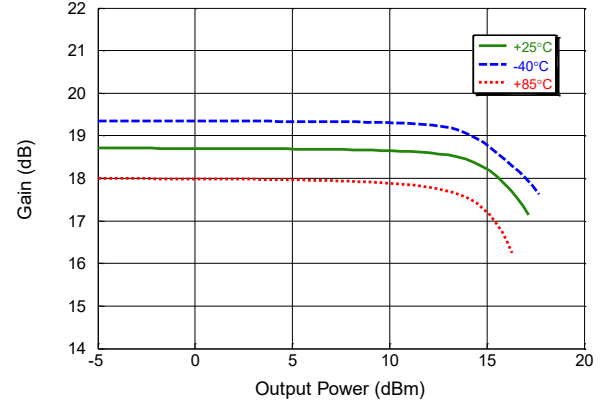

**OIP3 over swept Frequency (& Temp.) with  $P_{IN}$ /Tone = -35 dBm & 10 MHz tone spacing in HGM.**

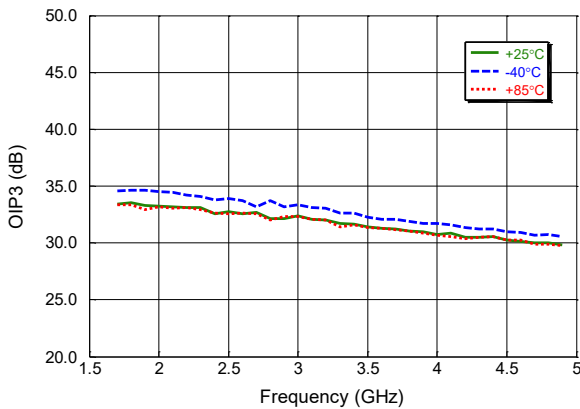

**OIP3 over swept Frequency (& Temp.) with  $P_{IN}$ /Tone = -25 dBm & 10 MHz tone spacing in LGM.**

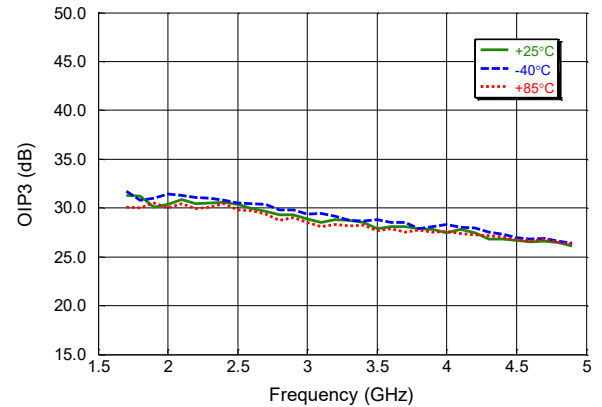

**OIP3 over swept Frequency (& Temp.) with  $P_{OUT}$ /Tone = 10 dBm & 11 MHz tone spacing in HGM.**

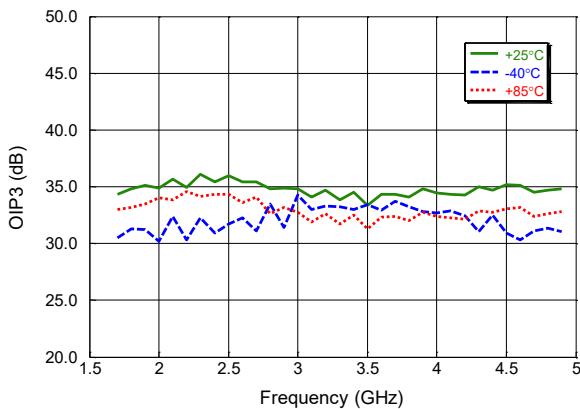

**OIP3 over swept Frequency (& Temp.) with  $P_{OUT}$ /Tone = 3 dBm & 11 MHz tone spacing in LGM.**

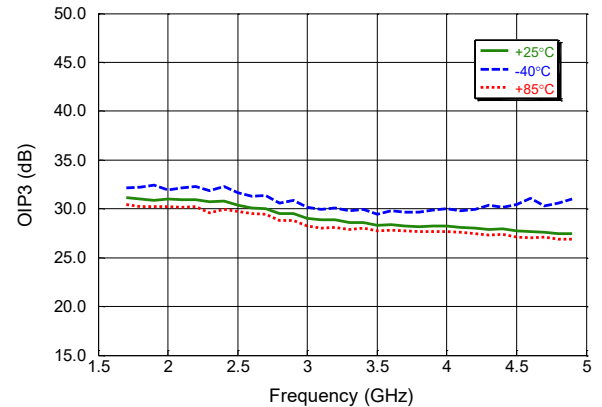



**Typical Performance Curves**

$P_{IN} = -10 \text{ dBm}$ ,  $V_{DD} = 5 \text{ V}$ ,  $T_C = +25^\circ\text{C}$ ,  $Z_0 = 50 \Omega$  (unless otherwise indicated)

**Switch Insertion Loss over swept Frequency (& Temp.)**

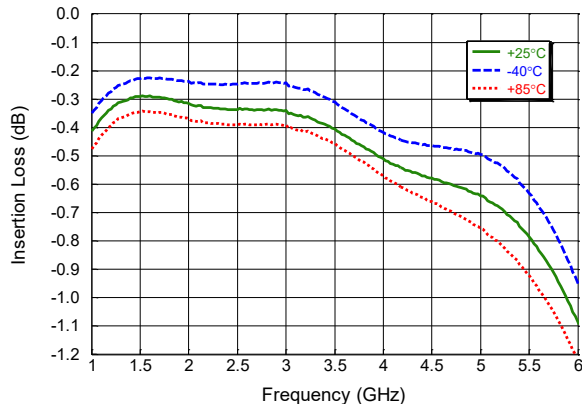

**RF<sub>IN</sub> to RF<sub>OUT</sub> Isolation over swept Frequency (& Temp.)**

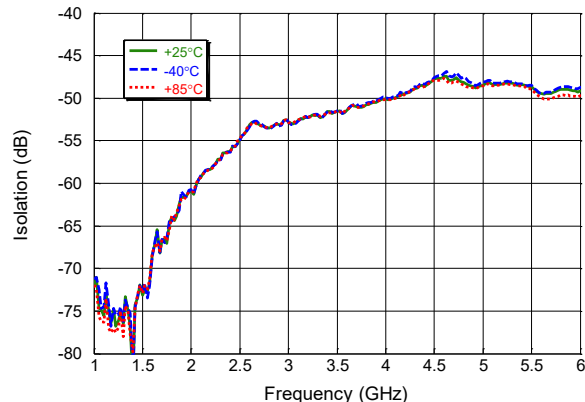

**RF<sub>IN</sub> Port Return Loss over swept Frequency (& Temp.)**

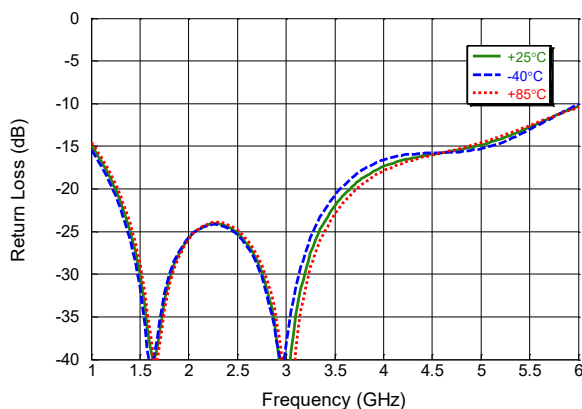

**LOAD Port Return Loss over swept Frequency (& Temp.)**

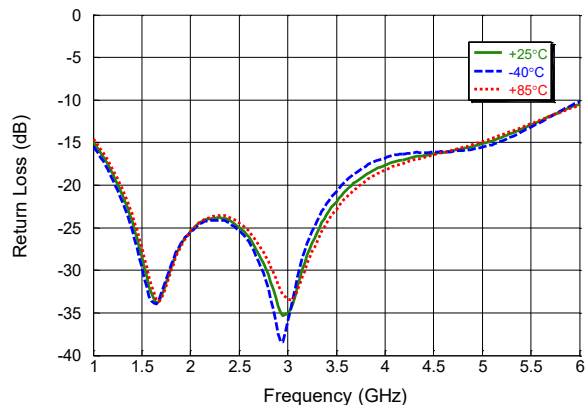

Lead-Free 5 mm 32-Lead HQFN<sup>†</sup>

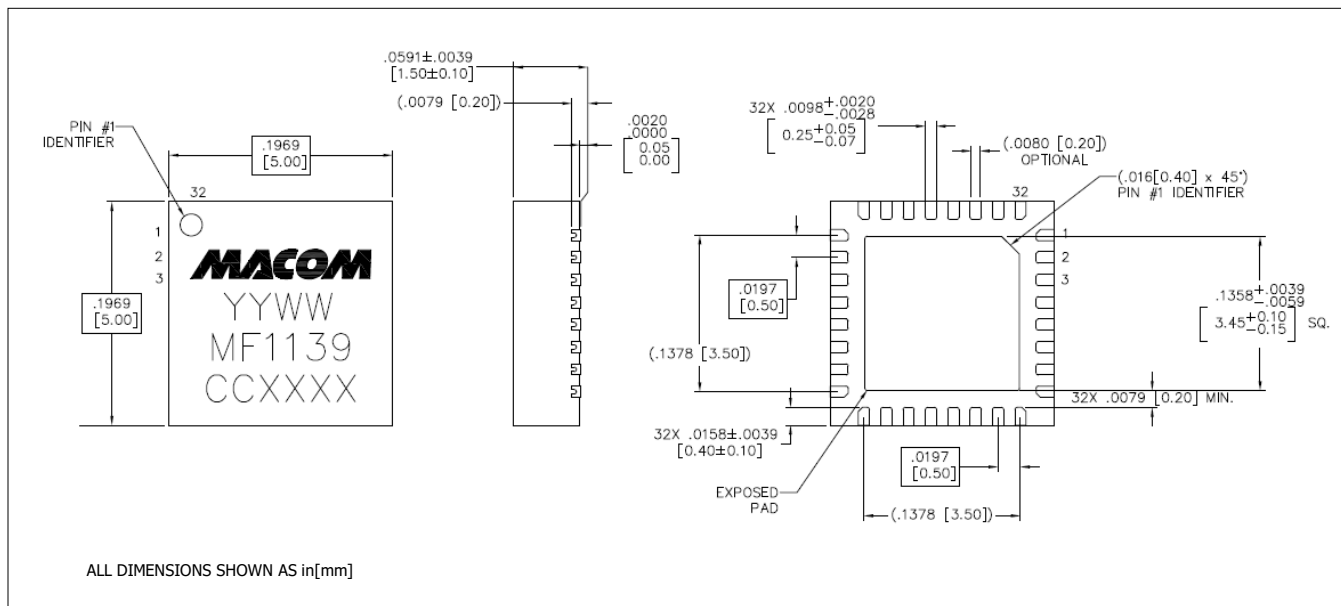

<sup>†</sup> Reference Application Note M538 for lead-free solder reflow recommendations.  
Meets JEDEC moisture sensitivity level 1 requirements.  
Plating is NiPdAuAg.

MACOM Technology Solutions Inc. ("MACOM"). All rights reserved.

These materials are provided in connection with MACOM's products as a service to its customers and may be used for informational purposes only. Except as provided in its Terms and Conditions of Sale or any separate agreement, MACOM assumes no liability or responsibility whatsoever, including for (i) errors or omissions in these materials; (ii) failure to update these materials; or (iii) conflicts or incompatibilities arising from future changes to specifications and product descriptions, which MACOM may make at any time, without notice. These materials grant no license, express or implied, to any intellectual property rights.

THESE MATERIALS ARE PROVIDED "AS IS" WITH NO WARRANTY OR LIABILITY, EXPRESS OR IMPLIED, RELATING TO SALE AND/OR USE OF MACOM PRODUCTS INCLUDING FITNESS FOR A PARTICULAR PURPOSE, MERCHANTABILITY, INFRINGEMENT OF INTELLECTUAL PROPERTY RIGHT, ACCURACY OR COMPLETENESS, OR SPECIAL, INDIRECT, INCIDENTAL, OR CONSEQUENTIAL DAMAGES WHICH MAY RESULT FROM USE OF THESE MATERIALS.

MACOM products are not intended for use in medical, lifesaving or life sustaining applications. MACOM customers using or selling MACOM products for use in such applications do so at their own risk and agree to fully indemnify MACOM for any damages resulting from such improper use or sale.