

Ka-Band TR Front End Module

24.25 - 29.5 GHz



MAMF-011099

Rev. V2

Features

- Broadband: 24.25 - 29.5 GHz
- RX Gain: 24 dB
- RX Noise Figure: 3.6 dB
- TX Gain: 21 dB
- TX P3dB
 - 28 dBm @ 5 V
 - 29 dBm @ 6 V
- Low Loss AlGaAs Diode Switch
- Integrated Switch Driver
- Integrated Directional Coupler
- Low DC Current
 - 80 mA in RX Mode
 - 530 mA in TX Mode
- Lead-Free 40 lead, 6.5 mm AQFN Package
- RoHS* Compliant

Applications

- 5G Applications in the 26 & 28 GHz Bands
- Satellite Communications

Description

The MAMF-011099 is a multifunction Ka-band module consisting of three MMICs, in a lead free 40 lead, 6.5 mm AQFN package. Functions include a low noise amplifier, power amplifier, switch, and switch driver. The RX path including the LNA and switch has a 3.6 dB noise figure with 24 dB of gain.

The TX path including the PA and switch has a 27 dBm P1dB with 21 dB of gain when biased with a 5 V supply. The P1dB and saturated output power may both be increased by 1 dB to 28 and 29 dBm respectively with a 6 V supply. The 15 dB coupled output for the TX path provides a means to measure the output power. The switch driver is included within the package.

Ordering Information¹

Part Number	Package
MAMF-011099	Bulk
MAMF-011099-TR0500	500 part reel
MAMF-011099-SMB	Sample Board

1. Reference Application Note M513 for reel size information.

Block Diagram

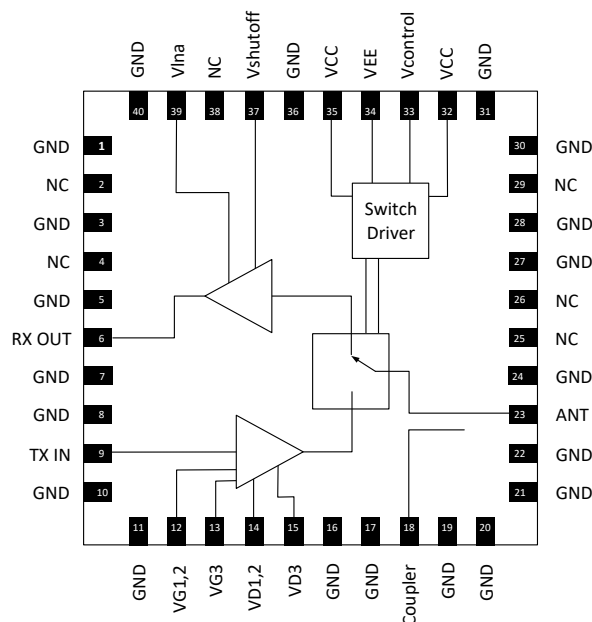

Pin Configuration^{2,3}

Pin #	Function
1,3,5,7,8,10,11,16,17,19-22,24,27,28,30,31,36,40	GND
2,4,25,26,29,38	No Connection
6	RX Out
9	TX In
12	VG1,2
13	VG3
14	VD1,2
15	VD3
18	Coupled Output
23	Antenna Port
32,35	V _{CC}
33	V _{CONTROL}
34	V _{EE}
37	V _{SHUTOFF}
39	V _{LNA}
Paddle	GND

2. It is recommended that all NC (No Connection) pins be grounded.

3. The exposed pad centered on the package bottom must be connected to RF, DC and thermal ground.

* Restrictions on Hazardous Substances, compliant to current RoHS EU directive.

Ka-Band TR Front End Module

24.25 - 29.5 GHz



MAMF-011099

Rev. V2

Electrical Specifications:

$V_{LNA} = +5\text{ V}$, $V_{PA} = +5\text{ V}$, $I_{DQ}(PA) = 530\text{ mA}$, $V_{CC} = +5\text{ V}$, $V_{EE} = -5\text{ V}$, $T_A = 25^\circ\text{C}$, $Z_0 = 50\ \Omega$

Parameter	Test Conditions	Units	Min.	Typ.	Max.
RX Noise Figure	24.25 - 27.5 GHz 27.5 - 29.5 GHz	dB	—	3.8 3.6	—
RX Gain	24.25 - 29.5 GHz	dB	20	24	—
RX Input Return Loss	24.25 - 29.5 GHz	dB	—	10	—
RX Output Return Loss	24.25 - 29.5 GHz	dB	—	10	—
RX P1dB	24.25 - 29.5 GHz	dBm	—	16.5	—
RX IP3	24.25 - 29.5 GHz	dBm	—	25	—
TX Gain	24.25 - 29.5 GHz	dB	18	21	—
TX Input Return Loss	24.25 - 29.5 GHz	dB	—	10	—
TX Output Return Loss	24.25 - 29.5 GHz	dB	—	15	—
TX P1dB	24.25 - 29.5 GHz	dBm	—	27	—
TX P3dB	24.25 - 29.5 GHz	dBm	—	28	—
TX IP3	24.25 - 27.5 GHz 27.5 - 29.5 GHz	dBm	—	31 33	—
Coupling Factor	24.25 - 29.5 GHz	dB	—	15	—
Directivity	24.25 - 29.5 GHz	dB	—	10	—
LNA Current, Pin 35	$I_{DQ} = 80\text{ mA}$	mA	—	80	—
Positive Switch Current, Pin 32	RX and TX modes	mA	—	13	—
Negative Switch Current, Pin 34	RX and TX modes	mA	—	-13	—
Switching Speed TX Mode Switch T_{ON} PA T_{ON} Switch T_{OFF} PA T_{OFF}	50% VCTRL to 90% RF 50% VCTRL to 90% RF 50% VCTRL to 10% RF 50% VCTRL to 10% RF	ns	—	20 39 72 126	—
Switching Speed RX Mode Switch T_{ON} LNA T_{ON} Switch T_{OFF} LNA T_{OFF}	50% VCTRL to 90% RF 50% VCTRL to 90% RF 50% VCTRL to 10% RF 50% VCTRL to 10% RF	ns	—	63 150 36 800	—

Switch Control

V _{LOGIC}	V _{CONTROL}	Thru Path
0	0 to 0.8 V	RX
1	2 to 5 V	TX

RX/TX Control

Thru Path	V _{CONTROL}	V _{SHUTDOWN}	V _{g1,2,3}
RX	0 to 0.8 V	0 V	-2 to -5 V
TX	2 to 5 V	-2 to -5 V	~ -0.81 V

Maximum Operating Ratings

Parameter	Absolute Maximum
RX Input Power	-7 dBm
TX Input Power	+6 dBm
Junction Temperature ^{4,5}	+160°C
Operating Temperature	-40°C to +105°C

4. Operating at nominal conditions with $T_J \leq +180^\circ\text{C}$ will ensure $\text{MTTF} > 1 \times 10^6$ hours.
5. TX Junction Temp. (T_J) = $T_C + \Theta_{jc} * ((V * I) - (P_{OUT} - P_{IN}))$.
 Typical TX thermal resistance (Θ_{jc}) = 19°C/W.
 a) For $T_C = +100^\circ\text{C}$,
 $T_J = 150^\circ\text{C}$ @ 5 V, 530 mA

Absolute Maximum Ratings^{6,7}

Parameter	Absolute Maximum
RX Input Power	-4 dBm
TX Input Power	+11 dBm
V _{LNA}	+6.5 V
V _D on PA	+6.5 V
V _{CC}	+6.5 V
V _{EE}	-6.5 V
Junction Temperature ⁸	+180°C
Storage Temperature	-55°C to +150°C

6. Exceeding any one or combination of these limits may cause permanent damage to this device.
7. MACOM does not recommend sustained operation near these survivability limits.
8. Junction temperature directly effects device MTTF. Junction temperature should be kept as low as possible to maximize lifetime.

Handling Procedures

Please observe the following precautions to avoid damage:

Static Sensitivity

These electronic devices are sensitive to electrostatic discharge (ESD) and can be damaged by static electricity. Proper ESD control techniques should be used when handling these HBM Class 1A devices.

Bias Sequence

The voltage supplies must be properly sequenced to avoid damage.

Power Up

1. Apply -5 V to PA VG pins 12 and 13, and LNA $V_{SHUTOFF}$ pin 37.
2. Apply +5 V on V_{CC} pins 32 and 35, V_{LNA} pin 39, and VD pins 14 and 15.
3. Apply -5 V on V_{EE} pin 34 (V_{EE} can be turned on at the same time as V_{CC} Pin @ +5V, but cannot be turned on prior to V_{CC}).

TX BIAS

1. Apply +5 V to $V_{CONTROL}$ pin 33 (TX).
2. Apply VG (about -0.81 V) to pins 12 and 13.
3. Adjust VG1,2 and VG3 to set I_{DQ} to 530 mA. VG1,2 and VG3 should always be the same voltage.
4. Apply -5 V on pins 12 and 13 to bias off PA before switching to RX Mode.

RX BIAS

1. Apply 0 V to $V_{CONTROL}$ pin 33 (RX Mode)
2. Apply 0 V to $V_{SHUTOFF}$ pin 37.
3. Apply -5 V to $V_{SHUTOFF}$ pin 37 to bias off LNA before switching to TX Mode.

Power Down

1. Turn off V_{EE} pin 34 and $V_{CONTROL}$ (V_{EE} can be turned off at the same time as V_{CC} pins 32 and 35, but cannot be turned off after V_{CC} pins)
2. Turn off V_{CC} pins 32 and 35, V_{LNA} pin 39, and VD pins 14 and 15.
3. Turn off -5V on VG pins 12 and 13, and $V_{SHUTOFF}$ pin 37.

Sample Board

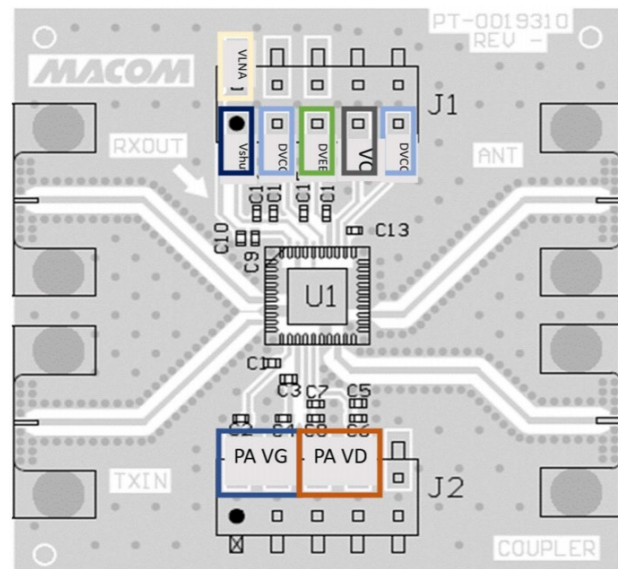

Typical Performance Curves for RX Mode:

RX Gain

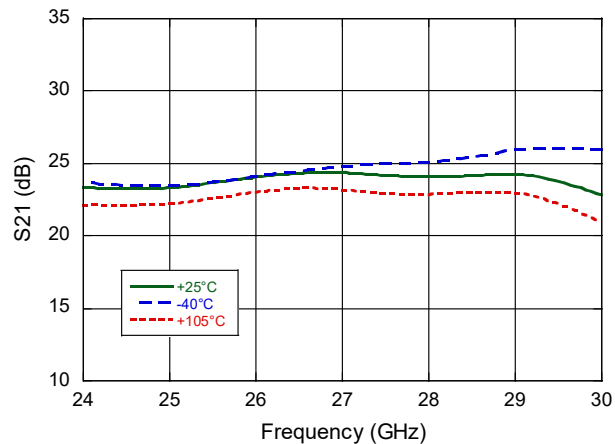

RX Noise Figure

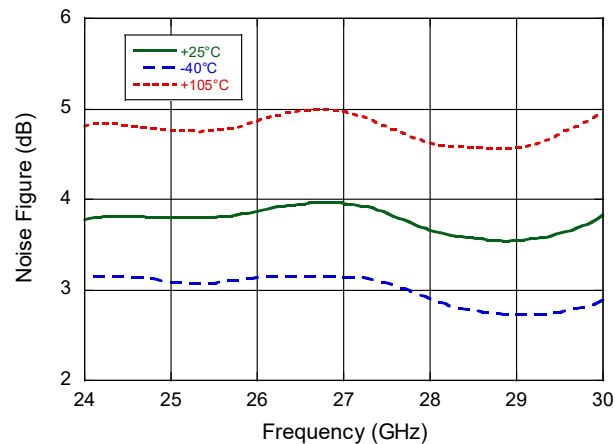

RX Input Return Loss

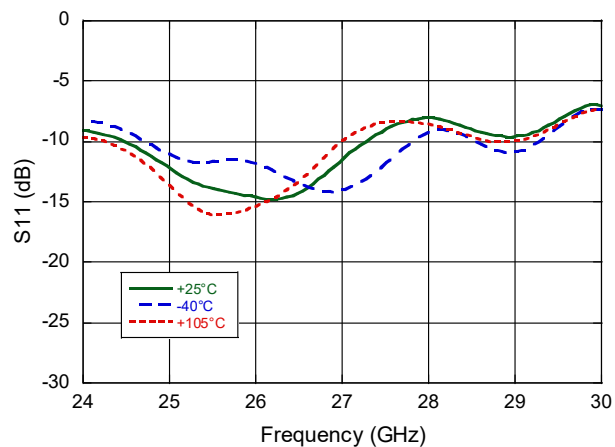

RX Output Return Loss

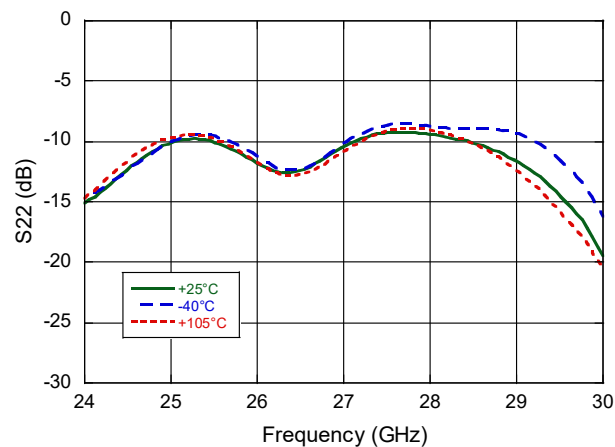

RX P1dB

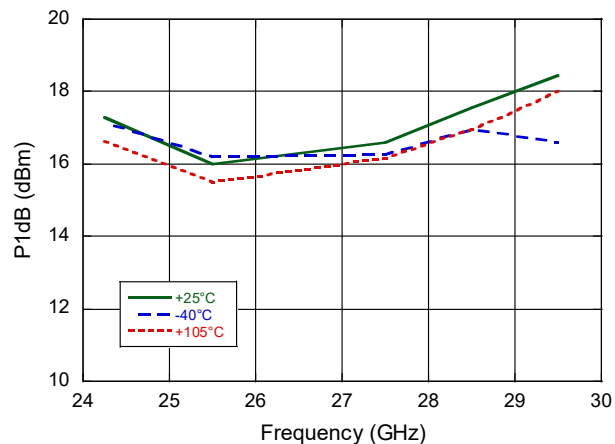

RX IP3

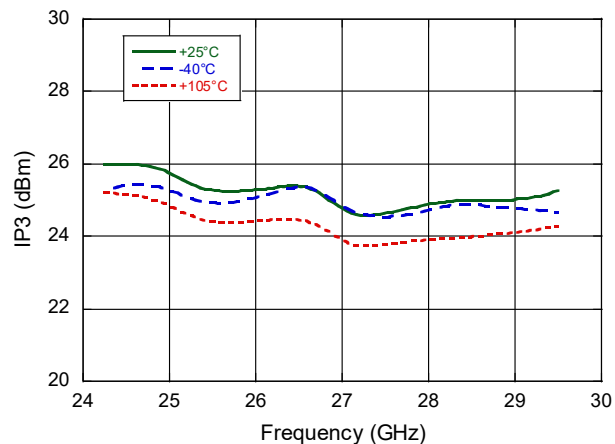

Typical Performance Curves for TX Mode:

TX Gain

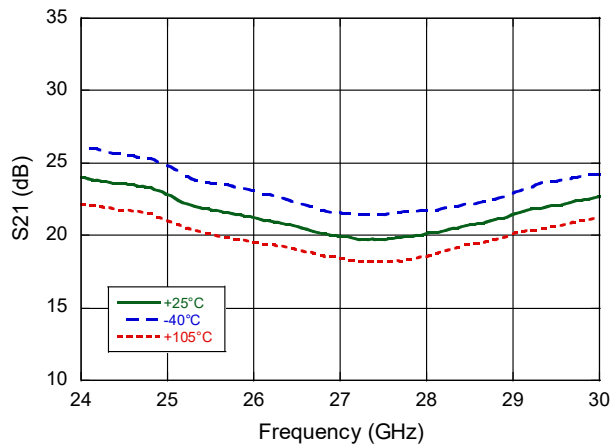

Coupler Factor

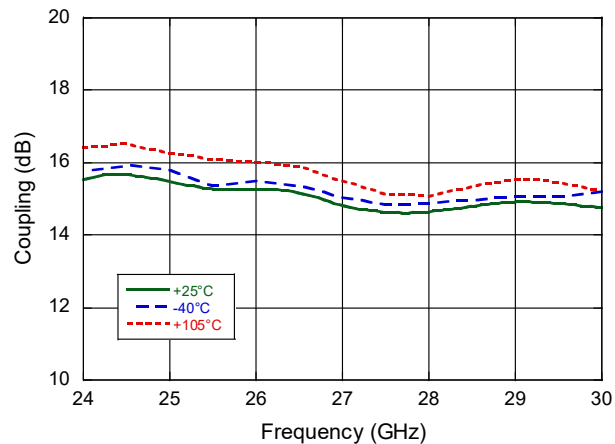

TX Input Return Loss

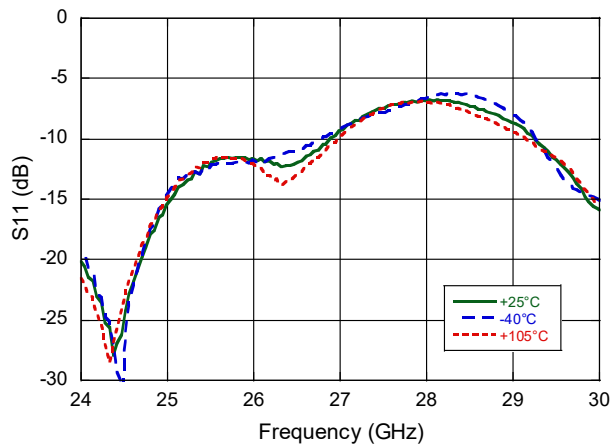

TX Output Return Loss

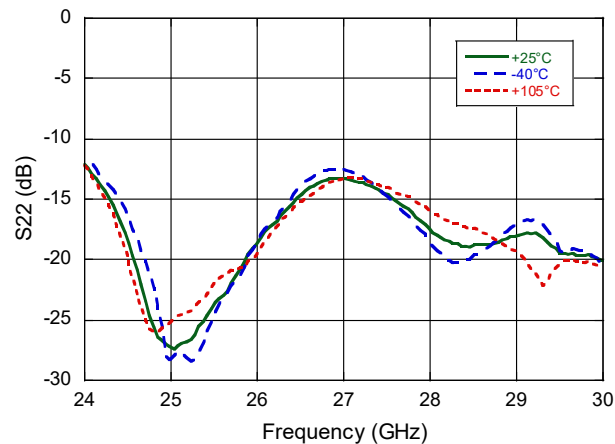

TX P1dB

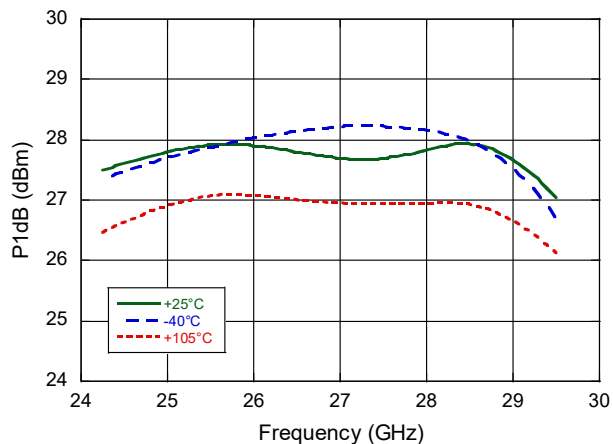

TX P3dB

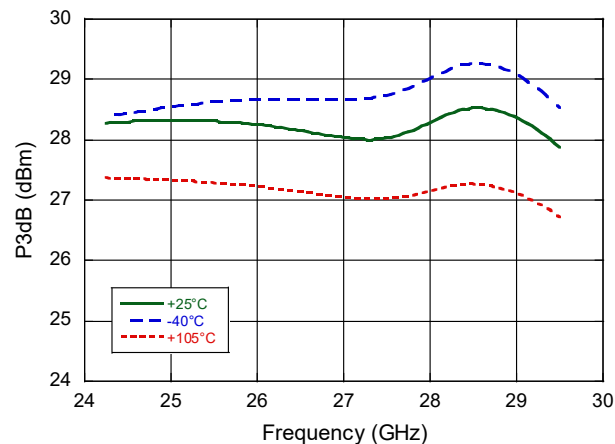

Ka-Band TR Front End Module

24.25 - 29.5 GHz



MAMF-011099

Rev. V2

Lead-Free 6.5 mm 40-Lead AQFN†

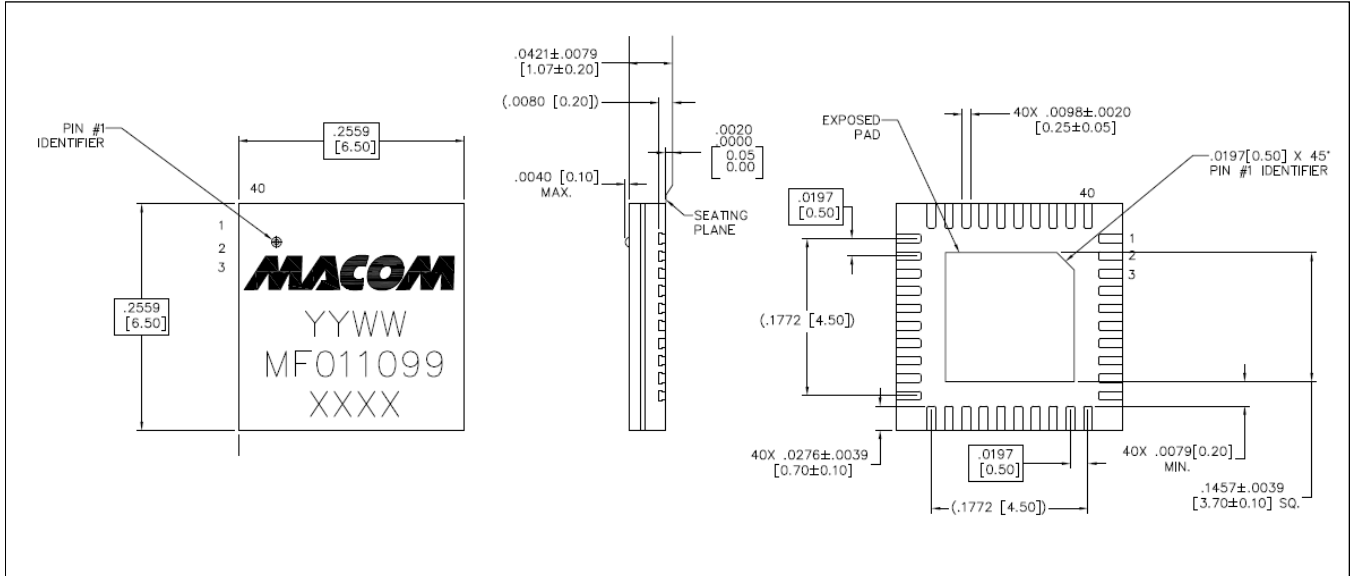

† Reference Application Note S2083 for lead-free solder reflow recommendations.
 Meets JEDEC moisture sensitivity level 3 requirements in accordance to JEDEC J-STD-020D.
 Plating is NiPdAu over Copper

MACOM Technology Solutions Inc. ("MACOM"). All rights reserved.

These materials are provided in connection with MACOM's products as a service to its customers and may be used for informational purposes only. Except as provided in its Terms and Conditions of Sale or any separate agreement, MACOM assumes no liability or responsibility whatsoever, including for (i) errors or omissions in these materials; (ii) failure to update these materials; or (iii) conflicts or incompatibilities arising from future changes to specifications and product descriptions, which MACOM may make at any time, without notice. These materials grant no license, express or implied, to any intellectual property rights.

THESE MATERIALS ARE PROVIDED "AS IS" WITH NO WARRANTY OR LIABILITY, EXPRESS OR IMPLIED, RELATING TO SALE AND/OR USE OF MACOM PRODUCTS INCLUDING FITNESS FOR A PARTICULAR PURPOSE, MERCHANTABILITY, INFRINGEMENT OF INTELLECTUAL PROPERTY RIGHT, ACCURACY OR COMPLETENESS, OR SPECIAL, INDIRECT, INCIDENTAL, OR CONSEQUENTIAL DAMAGES WHICH MAY RESULT FROM USE OF THESE MATERIALS.

MACOM products are not intended for use in medical, lifesaving or life sustaining applications. MACOM customers using or selling MACOM products for use in such applications do so at their own risk and agree to fully indemnify MACOM for any damages resulting from such improper use or sale.