

Features

- Conversion Gain:
 - $T_x = 3$ dB
 - $R_x = 11$ dB
- Receive:
 - Noise Figure = 3 dB
 - IIP3 = +5 dBm
- Transmit: IM3 = -40 dBc @ 0 dBm
- LO: 8 - 10 GHz & 0 dBm Drive
- Wide IF Bandwidth = 0.1 - 6.0 GHz
- Single 5 Volt DC Bias, 180 mA
- Lead-Free 4 mm 24-lead PQFN Package
- Halogen-Free "Green" Mold Compound
- RoHS* Compliant and 260°C Reflow Compatible

Description

The MAMF-011024 is a 21 - 27 GHz transceiver IC. It integrates an LNA, PA, T_x/R_x switch, bi-directional mixer, filtering, and LO frequency x2 multiplier with amplification. This device is assembled in a lead-free 4 mm 24 lead PQFN surface mount plastic package.

This transceiver operates either in receive or in transmit TDD (Time Division Duplex) mode. Receive and transmit circuitry can be turned off during transmit and receive, respectively. The T_x/R_x switch can be operated independently of the power up timing. It is powered from a single positive 5 V bias.

The MAMF-011024 is ideally suited for unlicensed 24 GHz ISM band applications.

Ordering Information^{1,2}

| Part Number | Package |
|---------------------|-------------------|
| MAMF-011024 -TR0500 | 500 piece reel |
| MAMF-011024 -SMB | Sample Test Board |

1. Reference Application Note M513 for reel size information.
2. All sample boards include 3 loose parts.

*Restrictions on Hazardous Substances,
European Union Directive 2011/65/EU.

Functional Schematic

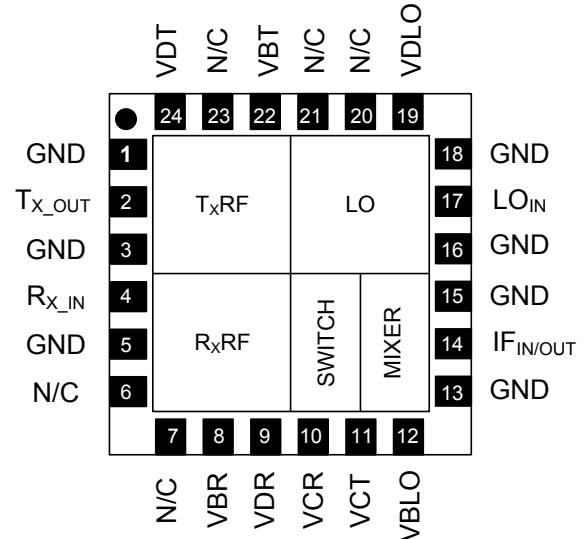

Pin Configuration³

| Pin No. | Description | Pin No. | Description |
|---------|----------------------|-----------------|---------------------|
| 1 | Ground | 13 | Ground |
| 2 | Transmit Output | 14 | IF Input / Output |
| 3 | Ground | 15 | Ground |
| 4 | Receive Input | 16 | Ground |
| 5 | Ground | 17 | LO Input |
| 6 | No Connection | 18 | Ground |
| 7 | No Connection | 19 | LO Drain Voltage |
| 8 | R_x Bias Adjust | 20 | No Connection |
| 9 | R_x Drain Voltage | 21 | No Connection |
| 10 | R_x Switch Control | 22 | T_x Bias Adjust |
| 11 | T_x Switch Control | 23 | No Connection |
| 12 | LO Bias Adjust | 24 | T_x Drain Voltage |
| | | 25 ⁴ | Ground |

3. MACOM recommends connecting all "No Connection" pins to ground.
4. The exposed pad centered on the package bottom must be connected to RF, DC and thermal ground.

Electrical Specifications: $T_A = 25^\circ\text{C}$, $R_F = 24\text{ GHz}$, $I_F = 5.6\text{ GHz}$, $L_O = 9.2\text{ GHz}$, 0 dBm , $Z_0 = 50\ \Omega$, $V_{DT} = V_{DR} = V_{DLO} = 5\text{ V}$, Control / Bias Adjust Voltages⁵ = $0 / 5\text{ V}$

| Parameter | Test Conditions | Units | Min. | Typ. | Max. |
|---------------------------------------|--|--------|-----------------|------------------|-----------------|
| LO: Drive Power | — | dBm | — | 0 | — |
| LO: Return Loss | — | dB | — | 12 | — |
| R _X : Down Conversion Gain | — | dB | 9 | 11 | — |
| R _X : Noise Figure | — | dB | — | 3 | — |
| R _X : Return Loss | — | dB | — | 11 | — |
| R _X : Input IP3 | — | dBm | — | +5 | — |
| R _X : LO Isolation | LO to IF port LO Frequency 2xLO Frequency 3xLO Frequency | dB | — | 22 33 55 | — |
| T _X : Up Conversion Gain | — | dB | 1 | 3 | — |
| T _X : Output Noise | — | dBm/Hz | — | -85 | — |
| T _X : Return Loss | — | dB | — | 15 | — |
| T _X : Output IM3 | +5 dBm P _{OUT} | dBc | — | -40 | — |
| T _X : LO Isolation | LO to T _X port LO Frequency 2xLO Frequency 3xLO Frequency | dB | — | 48 20 25 | — |
| IF: Return Loss | — | dB | — | 7 | — |
| Isolation | T _X Mode, R _X to IF R _X Mode, T _X to IF | dB | — | 69 58 | — |
| Current (sum of all DC currents) | T _X Mode R _X Mode Standby Mode | mA | 110 120 — | 150 160 <1 | 170 180 — |

5. See Truth Table.

Absolute Maximum Ratings^{6,7}

| Parameter | Absolute Maximum |
|-------------------------------|------------------|
| Input Power (R _x) | +15 dBm |
| Input Power (LO, IF) | +10 dBm |
| Voltage | 6 V |
| Junction Temperature | 150°C |
| Operating Temperature | -40°C to +85°C |
| Storage Temperature | -65°C to +150°C |

6. Exceeding any one or combination of these limits may cause permanent damage to this device.
7. MACOM does not recommend sustained operation near these survivability limits.

Handling Procedures

Please observe the following precautions to avoid damage:

Static Sensitivity

Gallium Arsenide Integrated Circuits are sensitive to electrostatic discharge (ESD) and can be damaged by static electricity. Proper ESD control techniques should be used when handling these devices.

Truth Table

| Mode / Pin | VBLO (V) | VBT (V) | VBR (V) | VCT (V) | VCR (V) |
|----------------|----------|---------|---------|---------|---------|
| R _x | +5 | 0 | +5 | 0 | +5 |
| T _x | +5 | +5 | 0 | +5 | 0 |
| Standby | 0 | 0 | 0 | 0 | 0 |

The MAMF-011024 is designed to be easy to use yet high performance. The ultra small size and simple bias allow easy placement on any system board. It requires no matching or external tuning elements; all RF ports are matched to 50 Ω .

The MAMF-011024 requires only a single +5 V power supply to operate. All VDX and VBX lines can be tied to the +5 V (with appropriate bypass capacitors) for simple operation. See the Truth Table for T_x/R_x/Standby modes of operation.

Evaluation Board

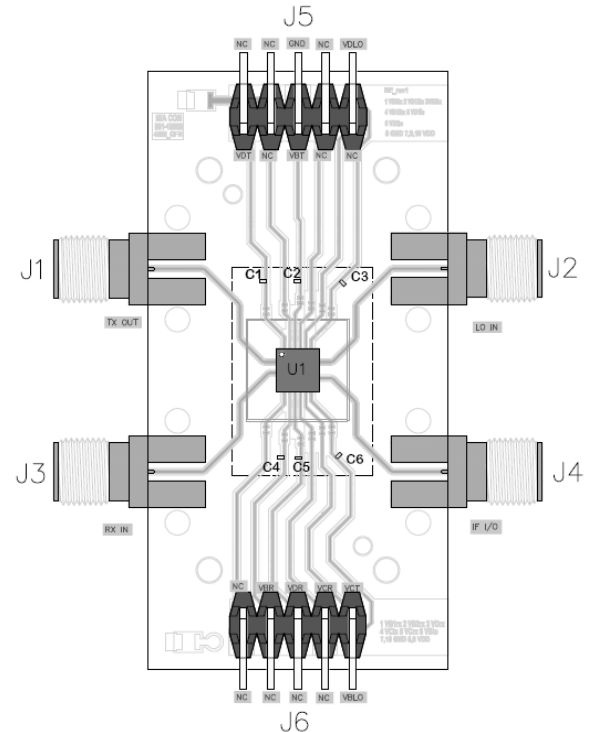

Parts List

| Component | Value | Package |
|-----------|--------------|---------|
| C1 - C6 | 0.22 μ F | 0201 |

Application Schematic

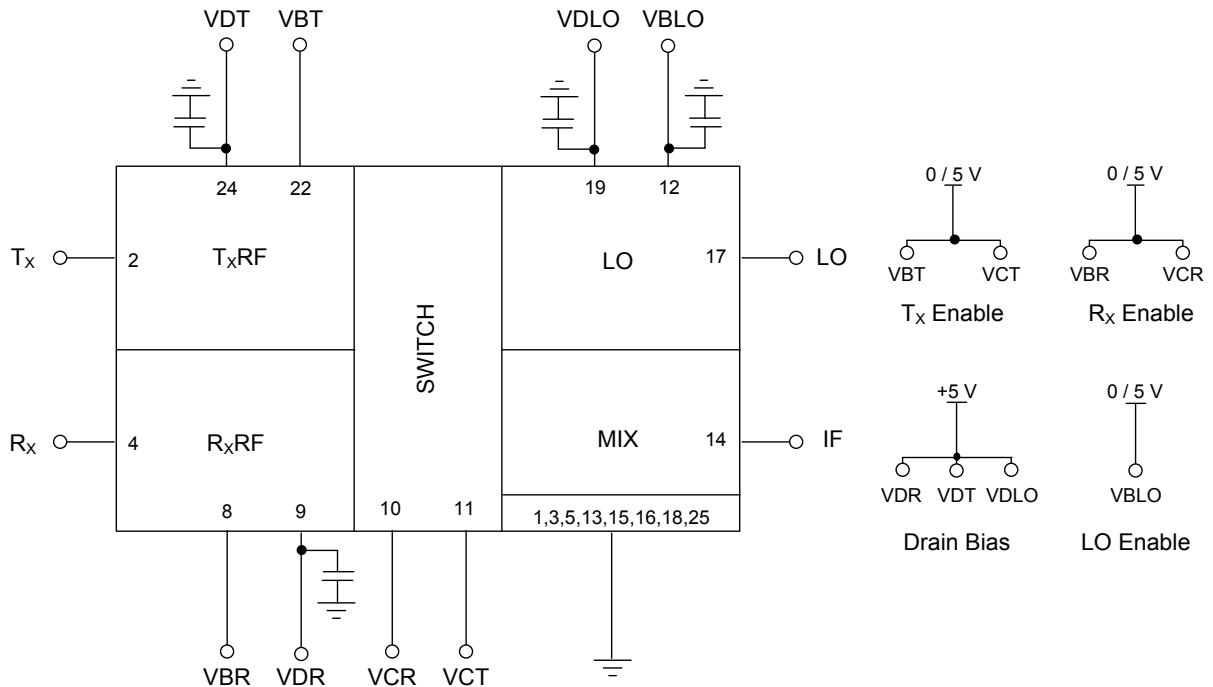

R_x (Receive) Typical Performance for Down-Conversion

Gain

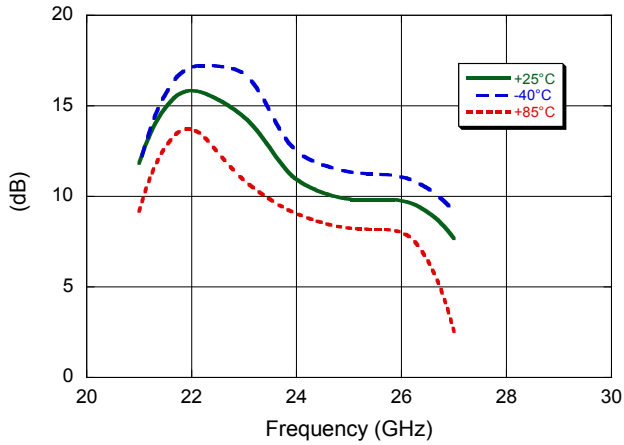

Input IP3

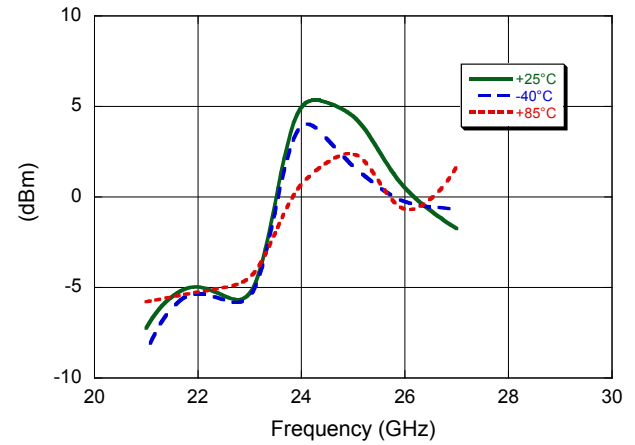

Noise Figure

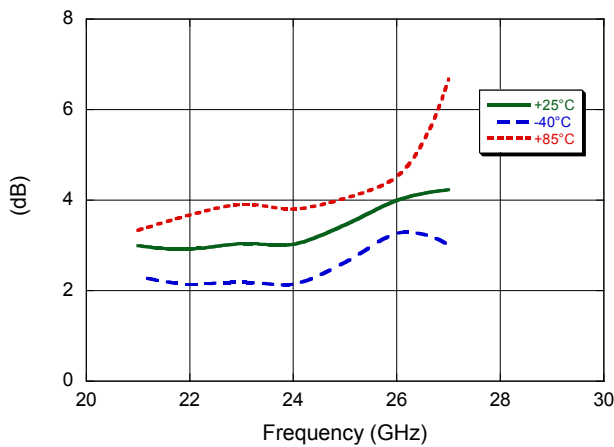

Input IP3 vs. IF Frequency, LO = 0 dBm

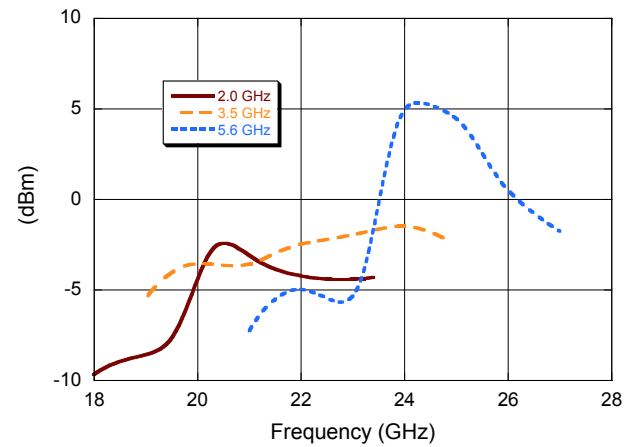

Isolation LO to IF

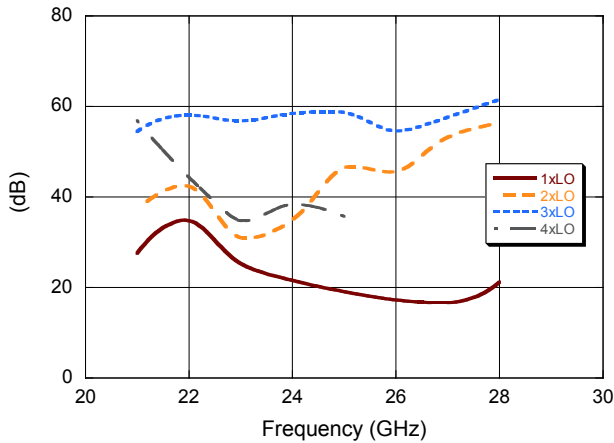

Conversion Gain vs. IF Frequency

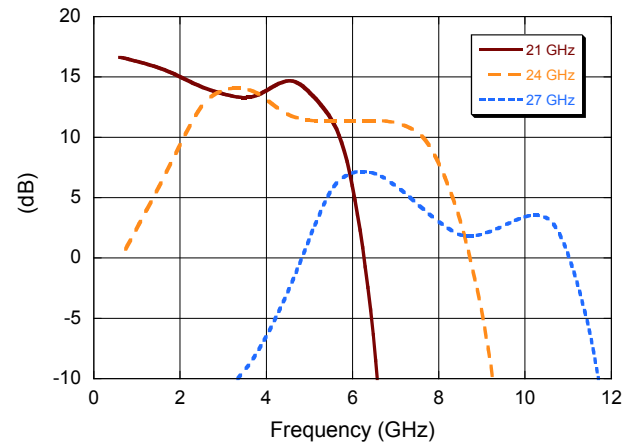

T_x (Transmit) Typical Performance for Up-Conversion

Gain

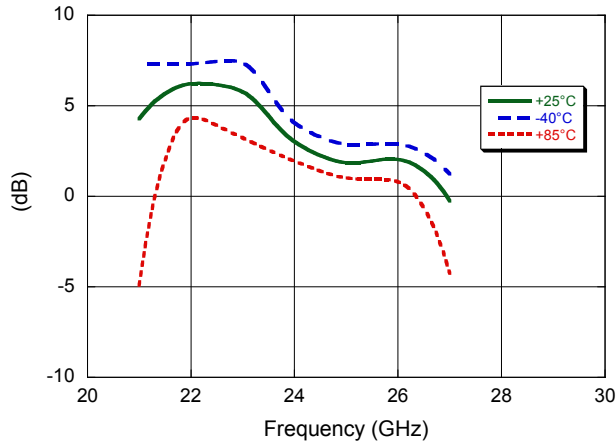

Output IM3 @ 5 dBm

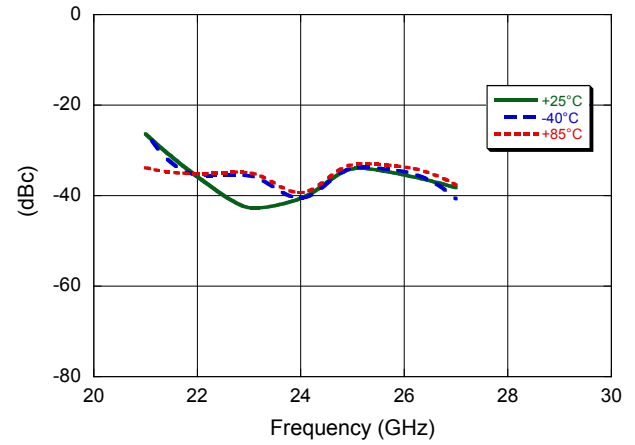

Output Noise

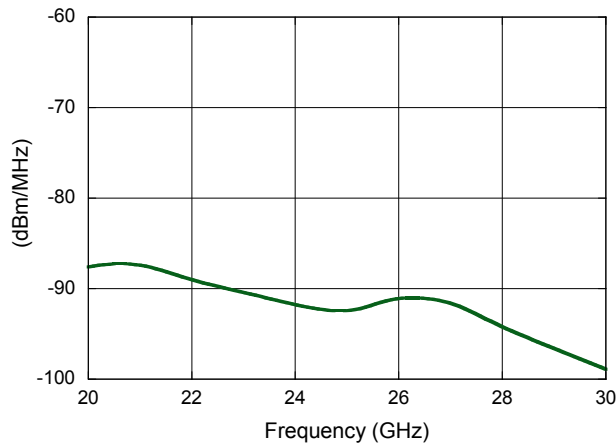

Output IM3 @ LO Input Power

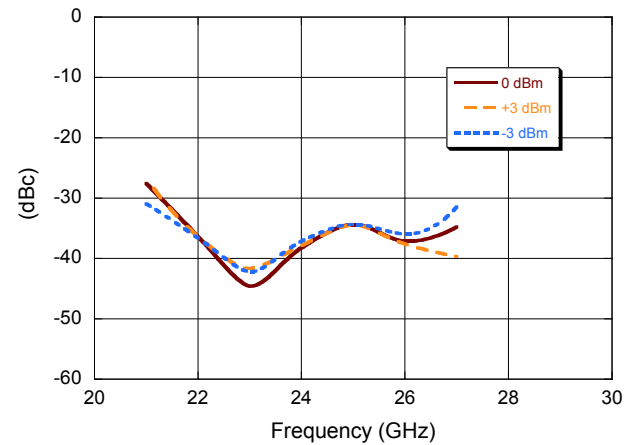

Isolation LO to T_x

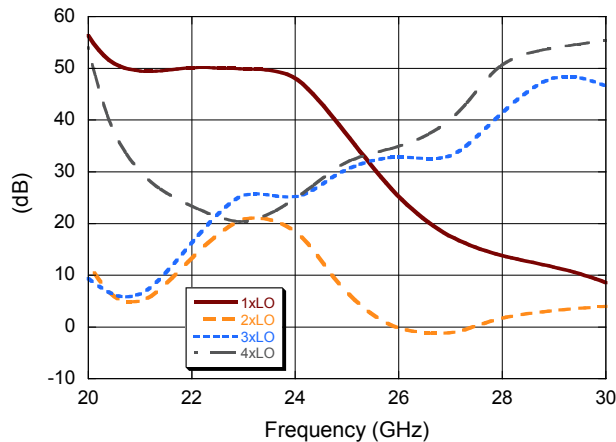

Conversion Gain vs. IF Frequency

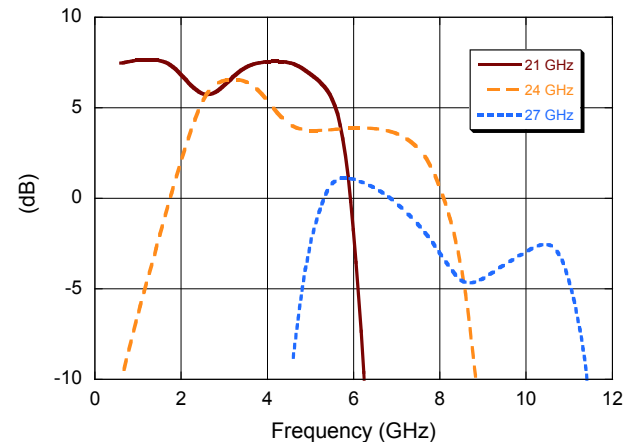

Typical Performance

R_x/T_x Input Return Loss

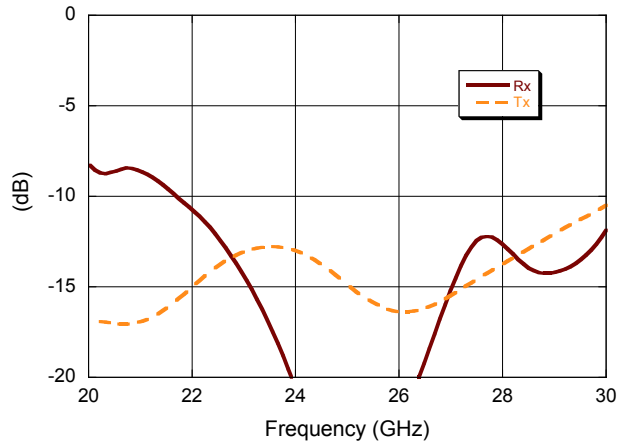

LO Return Loss vs. LO Frequency

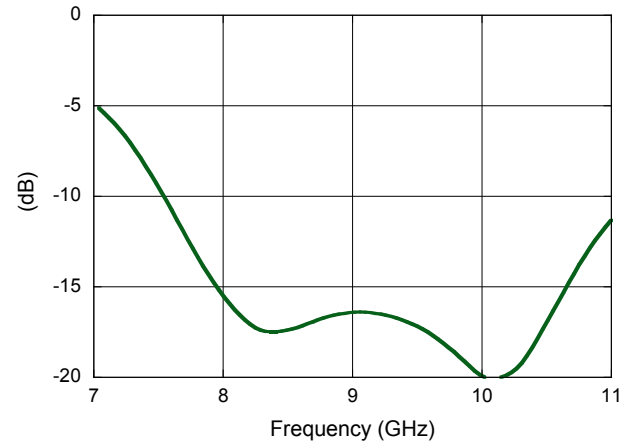

IF Return Loss vs. IF Frequency

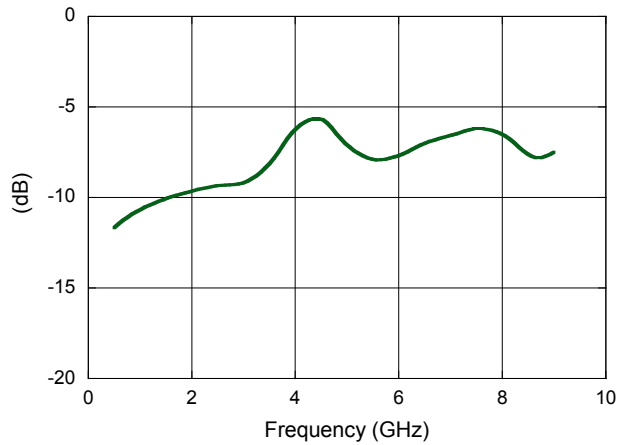

T_x Output Spectrum

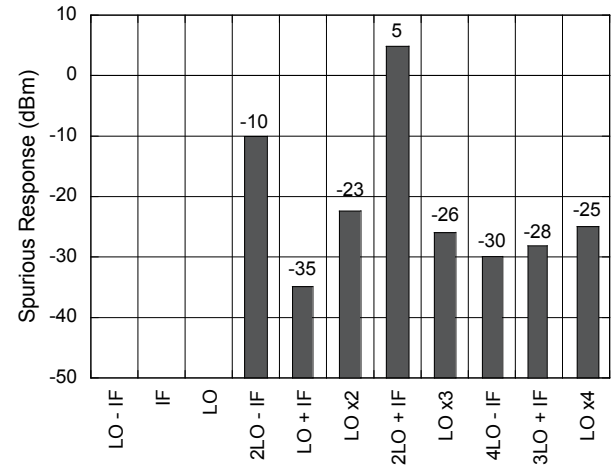

R_x Conversion Gain vs. LO Drive

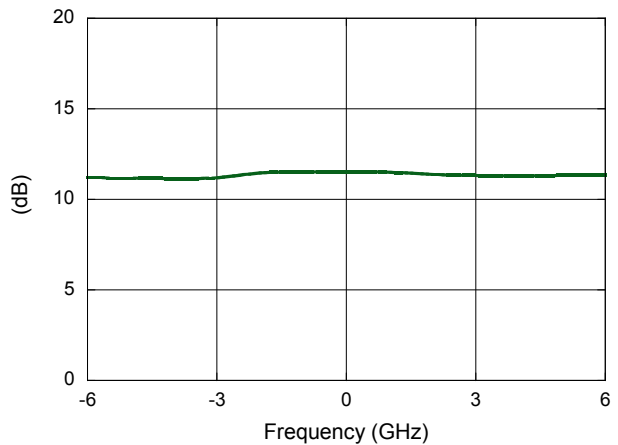

T_x Conversion Gain vs. LO Drive

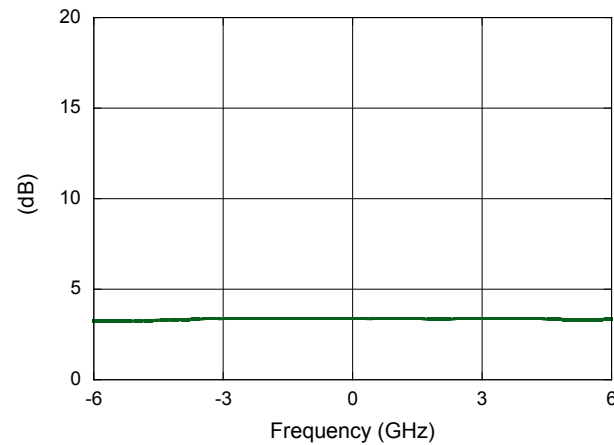

Lead-Free 4 mm 24-Lead PQFN[†]

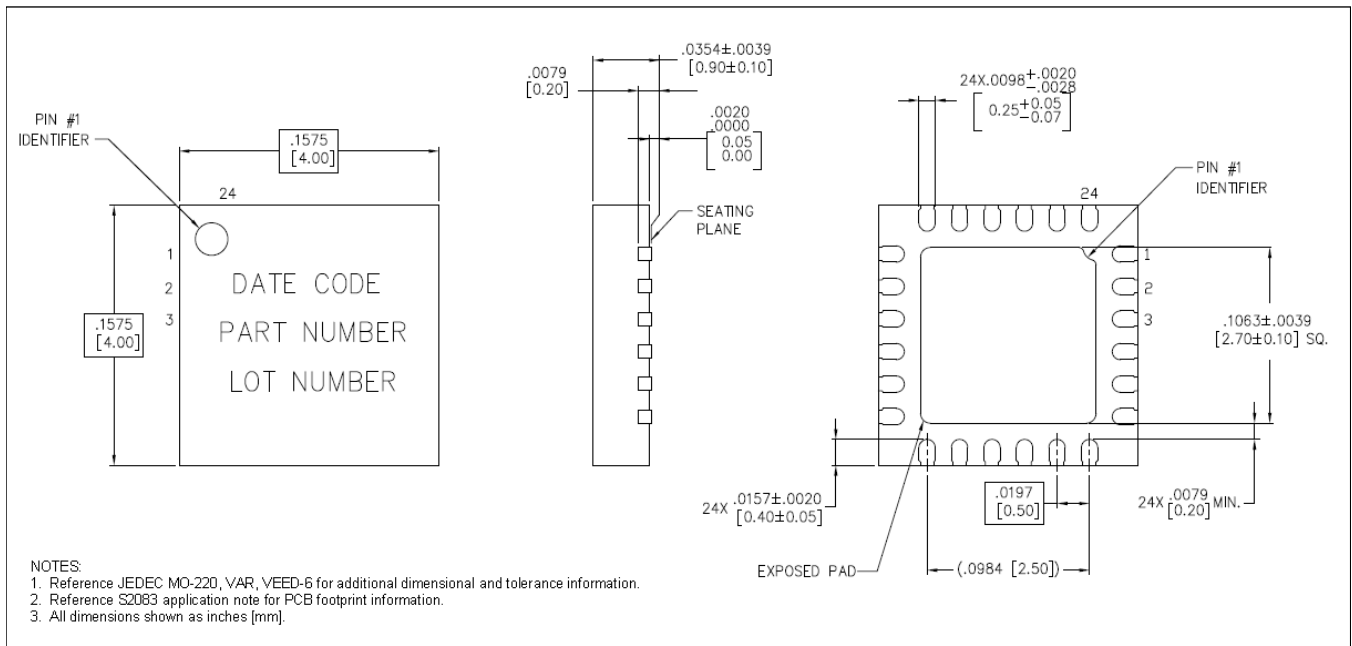

[†] Reference Application Note S2083 for lead-free solder reflow recommendations.
Meets JEDEC moisture sensitivity level 1 requirements.
Plating is NiPdAuAg.