

High Power Switch - LNA Module 0.4 - 4.0 GHz

Rev. V2

Features

- 2-Stage LNA and High Power Switch
- High RF Input Power:
 - 120 W CW @ +85°C, 2.0 GHz
 - 100 W CW @ +85°C, 2.7 GHz
- Noise Figure:
 - 0.85 dB @ 2.0 GHz
 - 1.0 dB @ 2.7 GHz
- Gain:
 - 37 dB @ 2.0 GHz
 - 34 dB @ 2.7 GHz
- OIP3: 36 dBm
- Lead-Free 5 mm 32-Lead HQFN
- Halogen-Free "Green" Mold Compound
- ROHS* Compliant

Description

The MAIA-011002 is a compact surface mount module containing a PIN diode switch and two low noise amplifiers assembled in a 5 mm 32 lead HQFN plastic package. It was designed to be used at the input of the receive chain of TDD cellular base stations.

This module operates from 0.4 GHz to 4.0 GHz and features high power handling, very low noise figure and excellent linearity.

The connection between the output of LNA1 and the input of LNA2 is made outside of the module, making it possible for the user to add an attenuator or a filter.

The MAIA-011002 is ideally suited for TD-LTE base stations at 1.9, 2.3, 2.6 and 3.5 GHz.

Ordering Information^{1,2}

Part Number	Package
MAIA-011002-TR1000	1k Piece Reel
MAIA-011002-TR3000	3k Piece Reel
MAIA-011002-1SMB	2 - 3 GHz Sample Board
MAIA-011002-2SMB	3 - 4 GHz Sample Board

1. Reference Application Note M513 for reel size information.
2. All sample boards include 5 loose parts.

* Restrictions on Hazardous Substances, European Union Directive 2011/65/EU.

Functional Schematic

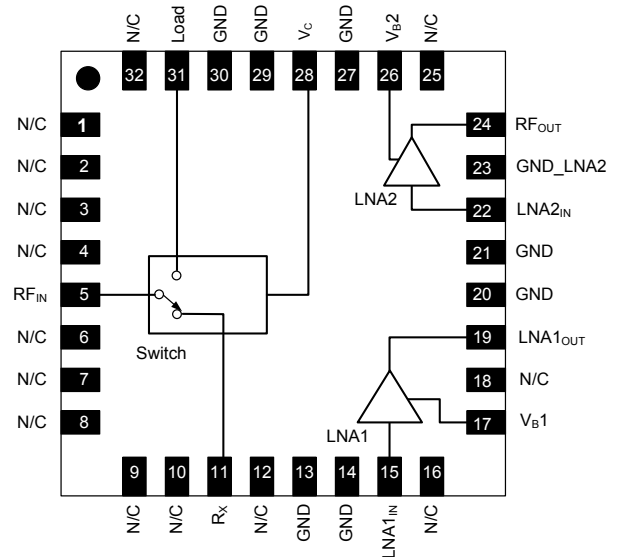

Pin Configuration

Pin No.	Pin Name	Function
1-4, 6-10, 12, 16, 18, 25, 32	N/C ³	No Connection
5	RF _{IN}	RF Input / Bias
11	R _X	R _X Switch Output
13, 14, 20, 21, 27, 29, 30	GND	RF Ground
15	LNA1 _{IN}	LNA1 Input
17	V _{B1}	LNA1 Bias
19	LNA1 _{OUT}	LNA1 Output / V _{DD1}
22	LNA2 _{IN}	LNA2 Input
23	GND_LNA2	LNA2 Ground ⁴
24	RF _{OUT}	RF Output / V _{DD2}
26	V _{B2}	LNA2 Bias
28	V _C	Switch Bias Control
31	Load	T _X Switch Output
33	Paddle	Ground ⁵

3. MACOM recommends connecting unused package pins (N/C) to ground.
4. Pin 23 must be connected to RF ground.
5. The exposed pad centered on the package bottom must be connected to RF, DC and thermal ground.

High Power Switch - LNA Module 0.4 - 4.0 GHz

Rev. V2

Electrical Specifications:

$T_A = +25^\circ\text{C}$, $V_{DD\text{LNA1}} = 3\text{ V}$, $V_{B1} = 3\text{ V}$, $V_{DD\text{LNA2}} = 3\text{ V}$, $V_{B2} = 3\text{ V}$

Switch Bias = (see Bias Table), LNA1 = 70 mA, LNA2 = 60 mA, $Z_0 = 50\ \Omega$

Parameter	Test Conditions	Units	Min.	Typ.	Max.
Input RF Power @ $+85^\circ\text{C}$ $\text{RF}_{\text{IN}} - \text{LOAD}$	2.0 GHz 2.7 GHz 3.5 GHz	W	—	120 100 80	—
Noise Figure $\text{RF}_{\text{IN}} - \text{RF}_{\text{OUT}}$	2.0 GHz 2.7 GHz 3.5 GHz	dB	—	0.85 1.00 1.25	—
Gain $\text{RF}_{\text{IN}} - \text{RF}_{\text{OUT}}$	2.0 GHz 2.7 GHz 3.5 GHz	dB	—	37 34 32	—
Isolation $\text{RF}_{\text{IN}} - \text{LNA1}_{\text{IN}}$	Switch State = $\text{RF}_{\text{IN}} - \text{LOAD}$ 2.7 GHz	dB	—	35	—
Isolation $\text{LNA1}_{\text{OUT}} - \text{LNA2}_{\text{IN}}$	Switch State = $\text{RF}_{\text{IN}} - \text{RF}_{\text{OUT}}$ 2.7 GHz	dB	—	40	—
Output IP3 $\text{RF}_{\text{IN}} - \text{RF}_{\text{OUT}}$	$P_{\text{IN}} = -35\text{ dBm}$, Tones 11 MHz apart 2.7 GHz	dBm	—	36	—
LNA Bias Current ⁶	LNA1 Current: $I_{\text{DD1}} + I_{\text{VB1}}$ LNA2 Current: $I_{\text{DD2}} + I_{\text{VB2}}$	mA	—	70 60	—

6. Refer to LNA biasing options on page 4.

Switch Bias Table (see Alternative Bias in the Application Note AN-0004117)

$\text{RF}_{\text{IN}} - \text{LOAD}$	$\text{RF}_{\text{IN}} - \text{RF}_{\text{OUT}}$	LOAD	R_x	V_c	RF_{IN}
ON	OFF	-15 V (-50 mA)	+15 V (50 mA)	GND	GND
OFF	ON	+15 V (0 mA)	-15 V (-50 mA)	GND	GND

Absolute Maximum Ratings^{7,8}

Parameter	Absolute Maximum
RF Input Power RF _{IN} - RF _{OUT} RF _{IN} - LOAD	19 dBm See Power De-rating Curve
Switch Reverse Voltage (RF & DC)	160 V
V _{B1} & V _{B2}	5.0 V
LNA _{1OUT} & RF _{OUT}	5.5 V
Junction Temperature ⁹ Switch LNA	+175°C +150°C
Operating Temperature	-40°C to +100°C
Storage Temperature	-55°C to +150°C

7. Exceeding any one or combination of these limits may cause permanent damage to this device.
8. MACOM does not recommend sustained operation near these survivability limits.
9. Operating at nominal conditions with T_{J1} ≤ +175°C of the switch and T_{J2} ≤ +150°C of LNA will ensure MTTF > 1 x 10⁶ hours.

T_x Input Power De-rating @ 20 dB I/O Return Loss

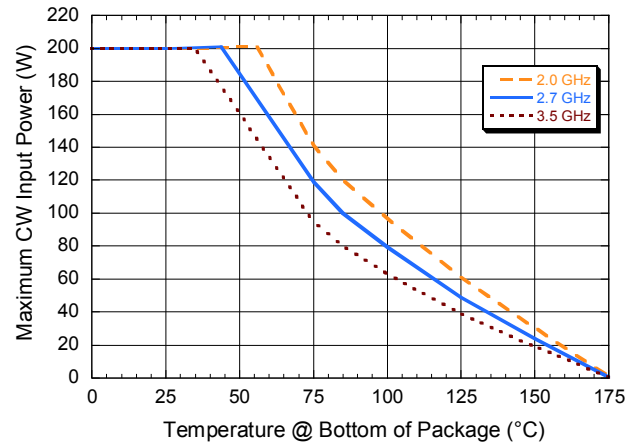

Handling Procedures

Please observe the following precautions to avoid damage:

Static Sensitivity

These electronic devices are sensitive to electrostatic discharge (ESD) and can be damaged by static electricity. Proper ESD control techniques should be used when handling these devices.

LNA Biasing Options

LNA1 and LNA2 biases can be set in 2 different ways: using only V_{DD} , or using separate V_{DD} and V_{BIAS} [V_B] voltages. A separate V_{BIAS} voltage allows V_{B1} and V_{B2} to be used as enable pins to power LNA 1 and 2 up and down during operation.

For both bias methods, select the value of R_{BIAS1} and R_{BIAS2} to achieve the desired currents using the plots on page 5. DC blocking capacitors must be used at the LNA1 and 2 Input and output ports (see diagram).

Biasing Option - V_{DD} only

To use only V_{DD} , connect to V_{DD} [1,2] through an RF inductor and connect V_B [1,2] to the corresponding V_{DD} through bias resistor R_{BIAS} [1,2] as shown in Figure 1.

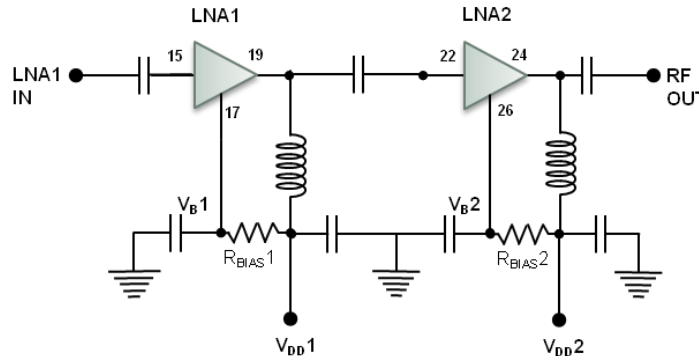

Figure 1

Biasing Option - Separate V_{DD} and V_B Voltages ($V_B \leq V_{DD}$)

To use separate V_{DD} and V_B voltages, connect to V_{DD} [1,2] through an RF inductor and connect to V_B [1,2] through bias resistor R_{BIAS} [1,2] as shown in Figure 2. Typical current draw for V_B [1,2] is 1.4 mA @ $V_B = 3$ V, and 1 μ A @ $V_B = 0$ V. Typical current draw for V_{DD} [1,2] is < 1 μ A @ $V_{BIAS} = 0$ V and $V_{DD} = 3$ V.

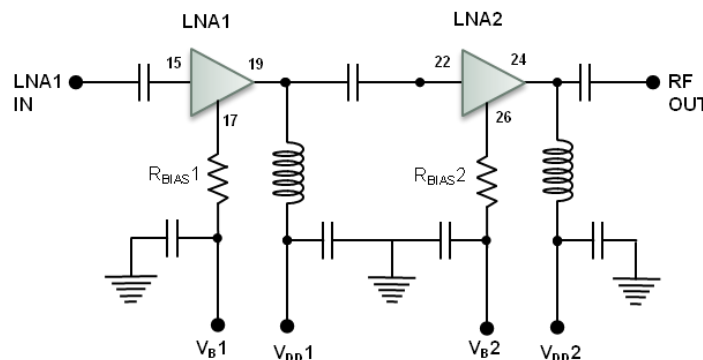
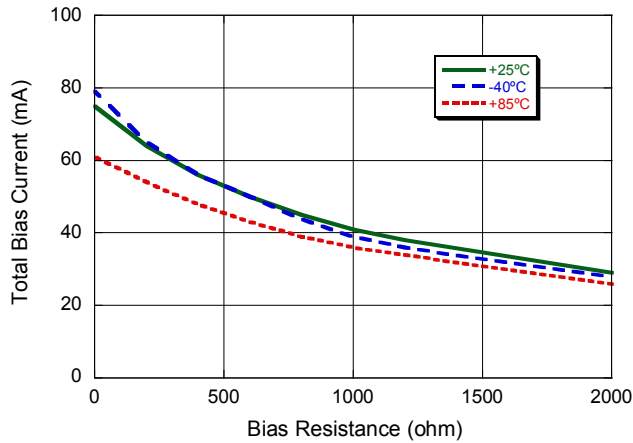

Figure 2

Typical Performance Curves: LNA1 Bias Circuit over Temperature

LNA1 Current, $V_{DD1} = 3\text{ V}$



LNA1 Current, $V_{DD1} = 5\text{ V}$

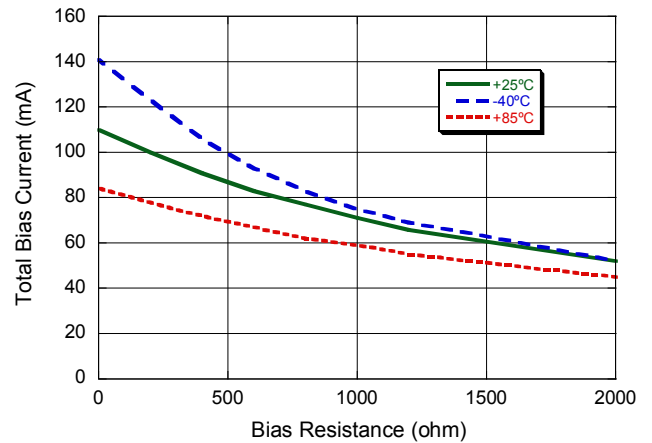

Typical Performance Curves: LNA2 Bias Circuit @ $T_A = 25^\circ\text{C}$

LNA2 Current, $V_{DD2} = 3\text{ V}$

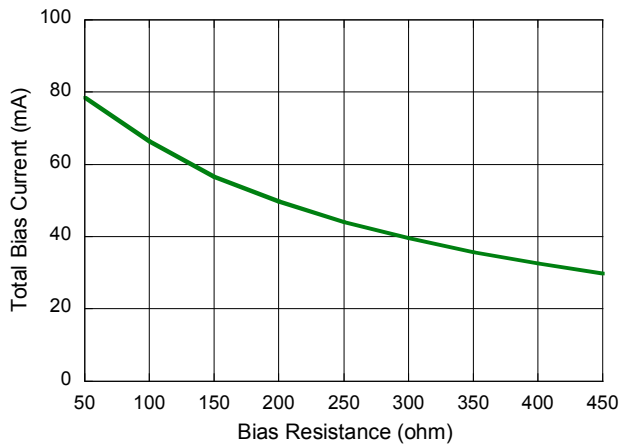

LNA2 Current, $V_{DD2} = 5\text{ V}$

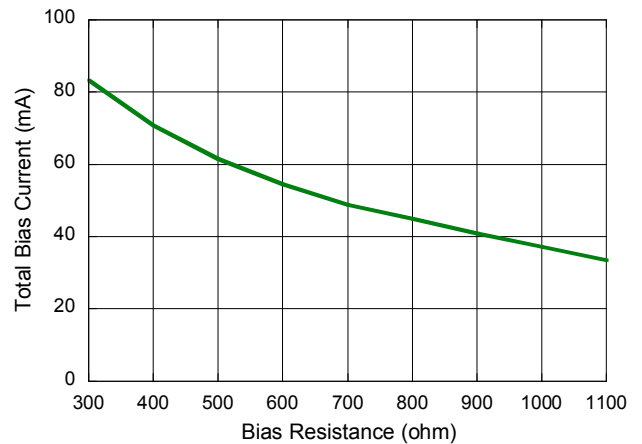

High Power Switch - LNA Module 0.4 - 4.0 GHz

Rev. V2

Typical Performance Curves: $T_A = +25^\circ\text{C}$, $Z_0 = 50\ \Omega$, $V_{DD} = 3\ \text{V}$, Switch State = RF_{IN} - RF_{OUT}

Gain vs. LNA1-2 Voltage

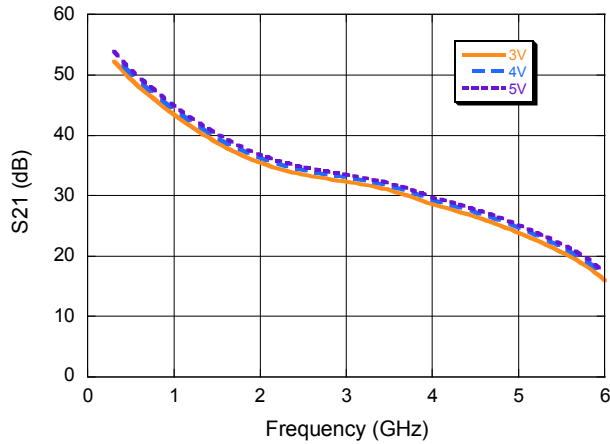

Noise Figure over Temperature, $V_{DD} = 3\ \text{V}$

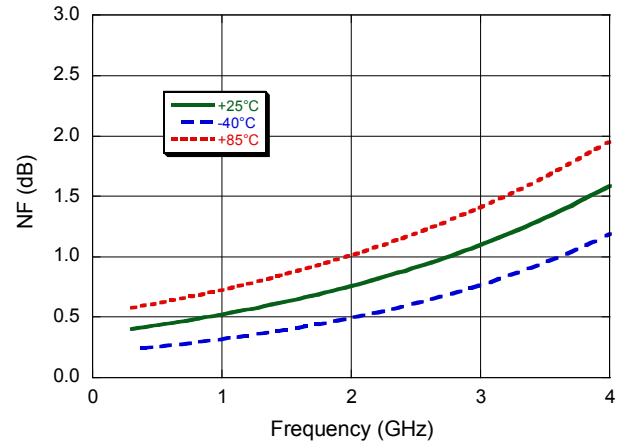

Input Return Loss vs. LNA1-2 Voltage

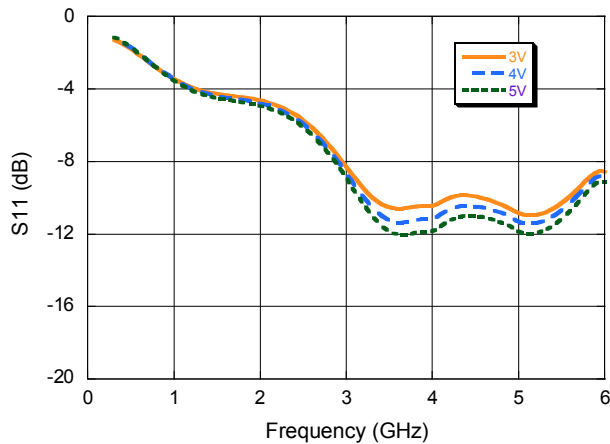

Output Return Loss vs. LNA1-2 Voltage

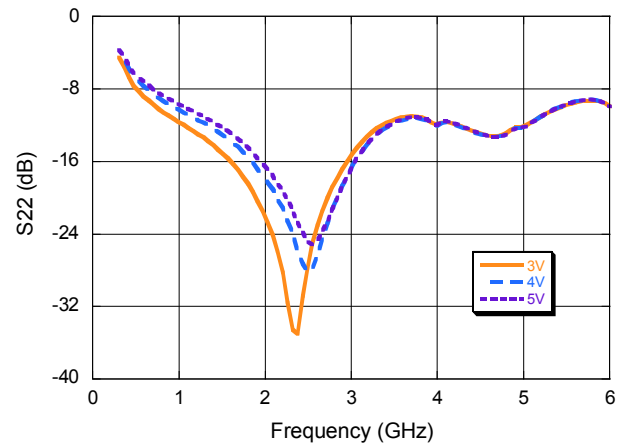

OIP3 vs. LNA1-2 Voltage

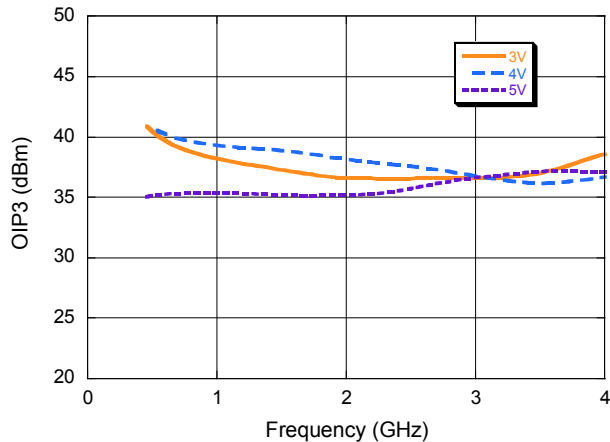

OIP3 over Temperature, $V_{DD} = 3\ \text{V}$

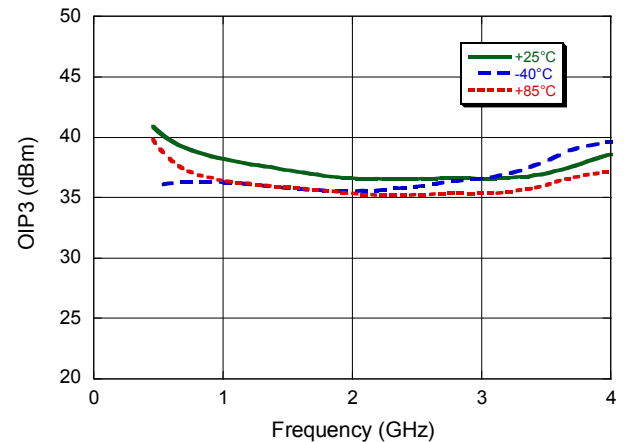

High Power Switch - LNA Module 0.4 - 4.0 GHz

Rev. V2

Typical Performance Curves: $T_A = +25^\circ\text{C}$, $Z_0 = 50 \Omega$, $V_{DD} = 3 \text{ V}$, $RF_{IN} - \text{LOAD}$

S21 vs. Switch Bias Current

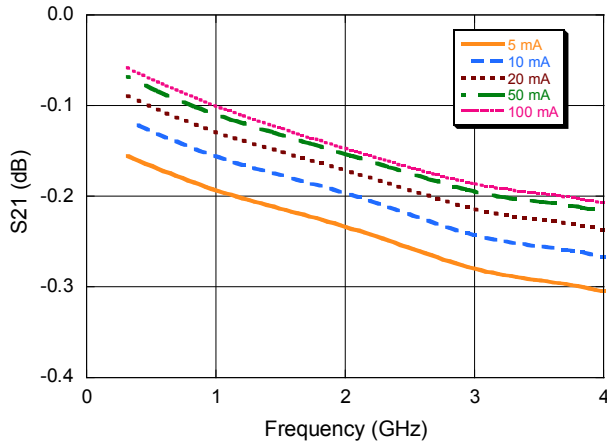

Isolation, RF_{IN} to LNA1 $_{IN}$ vs. Bias Current

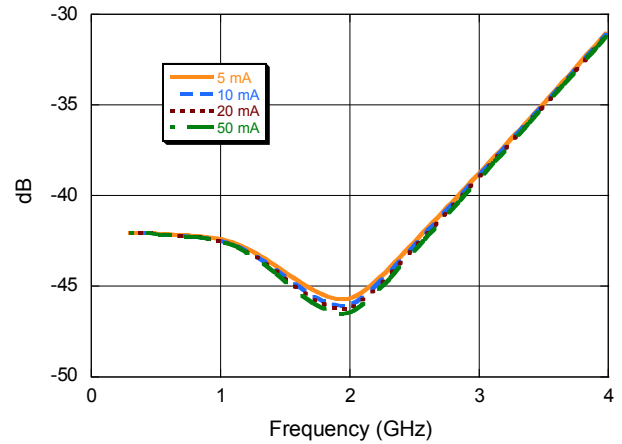

S11 vs. Switch Bias Current

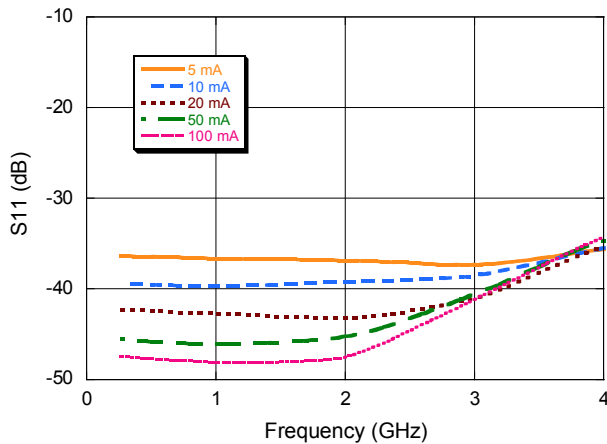

S22 vs. Switch Bias Current

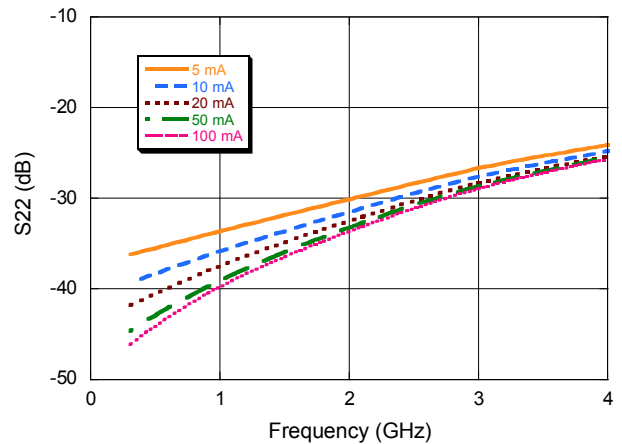

P1dB vs. LNA1-2 Voltage, State = $RF_{IN} - RF_{OUT}$

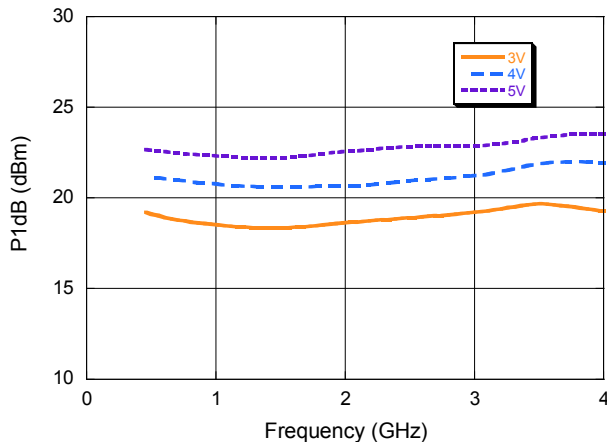

P1dB vs. Temperature, State = $RF_{IN} - RF_{OUT}$

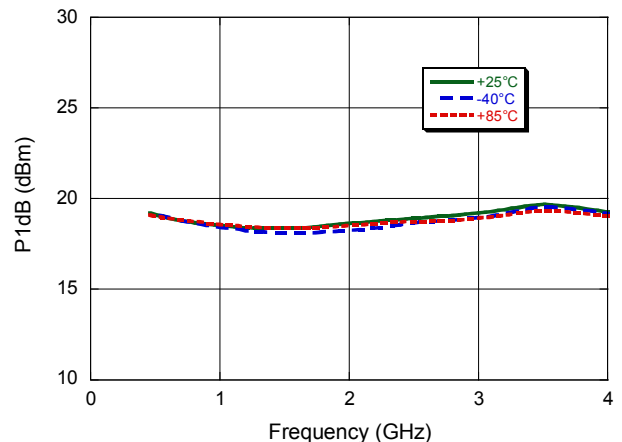

High Power Switch - LNA Module 0.4 - 4.0 GHz

Rev. V2

Electrical Specifications: $T_A = +25^\circ\text{C}$, $V_{DD\text{LNA1}} = 3\text{ V}$, $V_{B1} = 3\text{ V}$, $V_{DD\text{LNA2}} = 3\text{ V}$, $V_{B2} = 3\text{ V}$,
Switch Bias = (see Bias Table), LNA1 = 70 mA, LNA2 = 60 mA; Tuned for 2 - 3 GHz band

Parameter	Test Conditions	Units	Min.	Typ.	Max.
Gain	$RF_{IN} - RF_{OUT}$, 2.7GHz	dB	31	34	-
Noise Figure	$RF_{IN} - RF_{OUT}$, 2.7GHz	dB	-	1.1	1.5
Input Return Loss	$RF_{IN} - RF_{OUT}$, 2.7GHz	dB	-	11	-
Output Return Loss	$RF_{IN} - RF_{OUT}$, 2.7GHz	dB	-	18	-

Typical Performance Curves: 2 - 3 GHz tuned Sample Board, $RF_{IN} - RF_{OUT}$

Gain

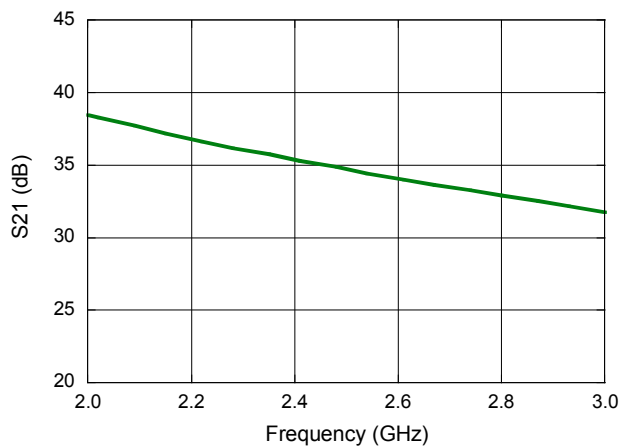

Noise Figure

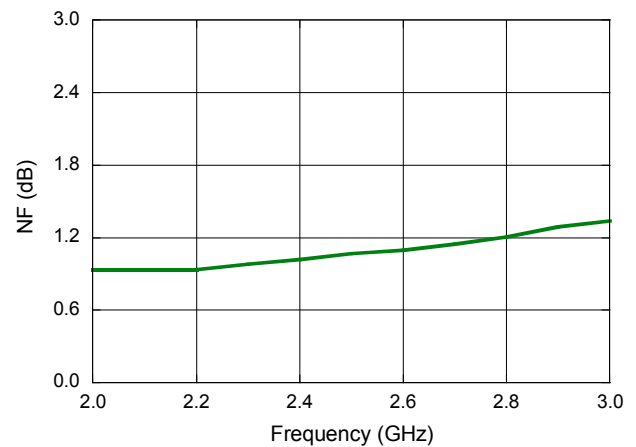

Input Return Loss

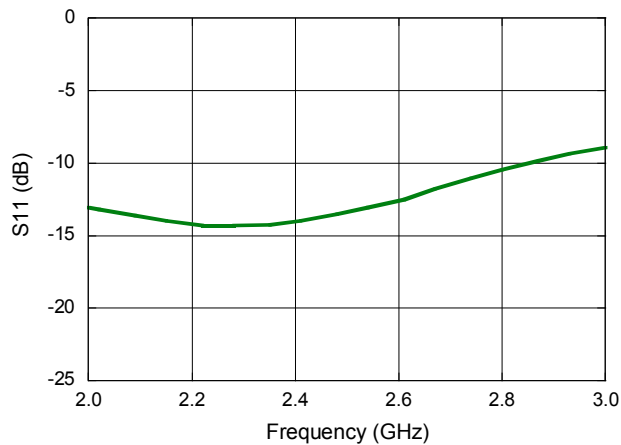

Output Return Loss

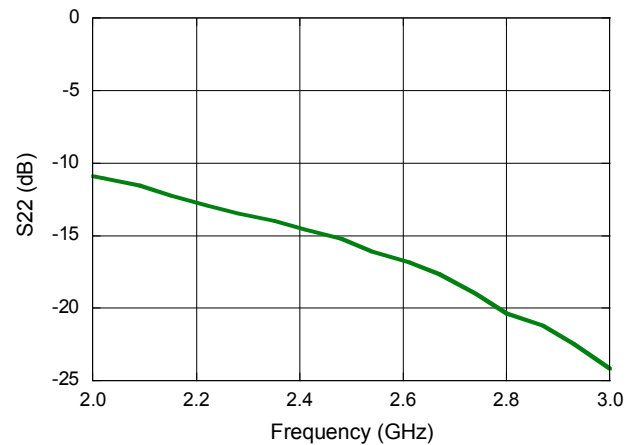

Schematic: MAIA-011002 Sample Board

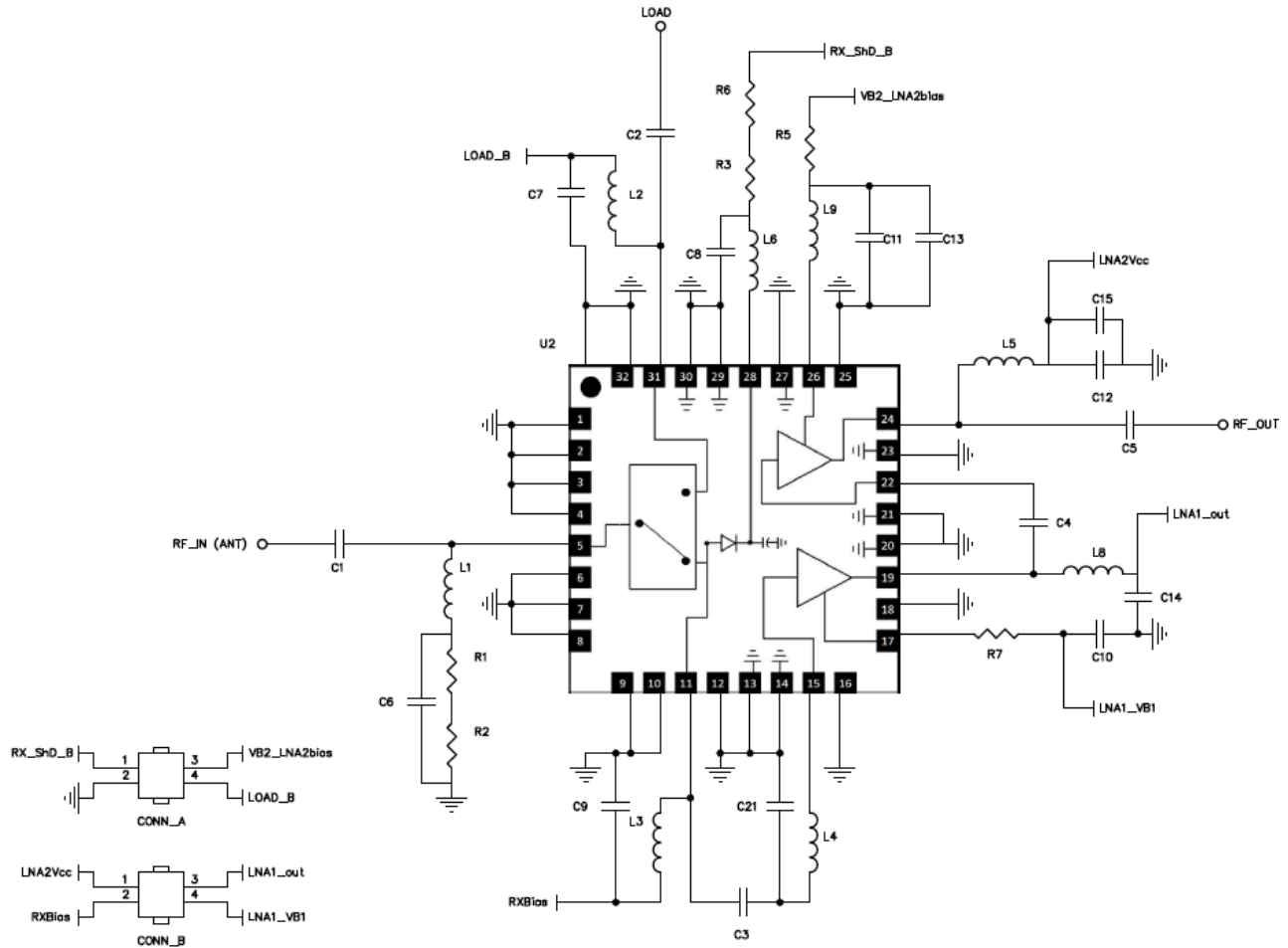

Sample Board - PCB Layout

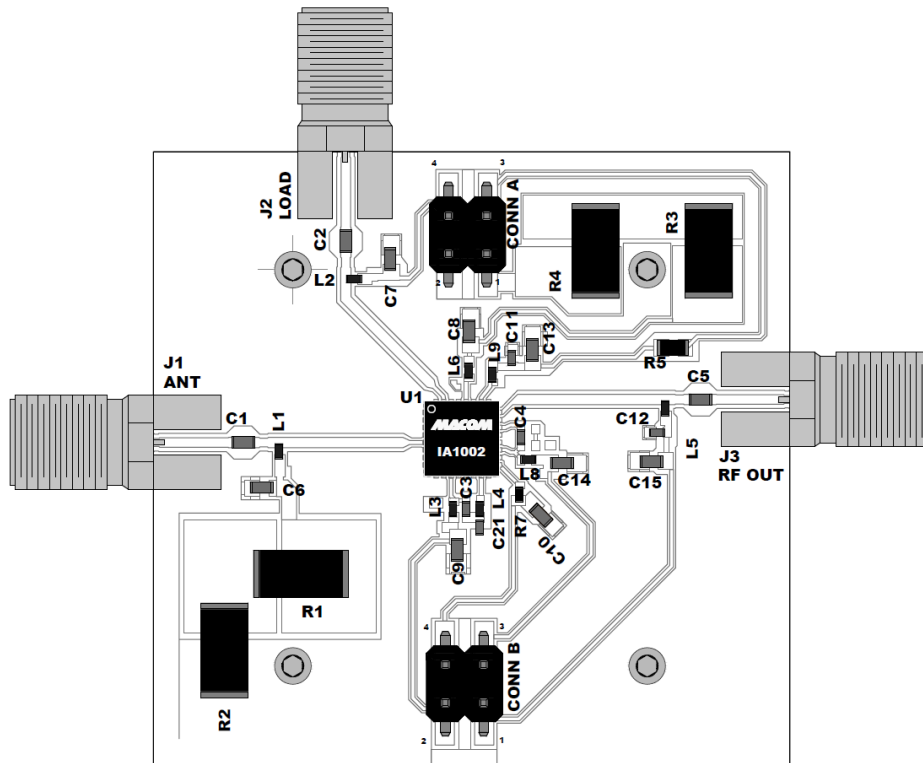

Sample Board Parts List* for 2 - 3 GHz Tuned PCB

Part	Value	Description	MFR Part #
C1, C2, C5,	27 pF / 250 V	0603 SMT Capacitor	ATC600S270GT250T
C3	22 pF / 250 V	0402 SMT Capacitor	ATC600L220FT200T
C4	3.3 pF / 50 V	0402 SMT Capacitor	GRM1555C1H3R3BA01D
C6, C7, C8, C9, C10, C13, C14, C15	4.7 μ F / 35 V	0603 SMT Capacitor	—
C11	10 nF / 25V	0402 SMT Capacitor	—
C12	1 nF / 25V	0402 SMT Capacitor	—
C21	0.40 pF \pm 0.1 pF	0402 SMT Capacitor	GJM1555C1HR40BB01
L1, L2, L3, L5, L6, L9	68 nH / 100 mA	0402 SMT Inductor	0402CS-68NXJLW
L4	2.7 nH	0402 SMT Inductor	0402CS-2N7XJLU
L8	2.0 nH	0402 SMT Inductor	0402CS-2N0XJLU
R1, R2, R3, R4	133 Ω / 1.50 W	2512 SMT Resistor	—
R5	133 Ω	0805 SMT Resistor	—
R7	100 Ω	0402 SMT Resistor	—
J1 - J3	SMA END LAUNCH	RF CONNECTOR	142-0761-821
C16, C18, C19, C20, C22	do not populate		
* Aluminum heat sink mounted to backside of PCB is not shown			

High Power Switch - LNA Module 0.4 - 4.0 GHz

Rev. V2

Electrical Specifications: $T_A = +25^\circ\text{C}$, $V_{DD\text{LNA1}} = 3\text{ V}$, $V_{B1} = 3\text{ V}$, $V_{DD\text{LNA2}} = 3\text{ V}$, $V_{B2} = 3\text{ V}$,
Switch Bias = (see Bias Table), LNA1 = 70 mA, LNA2 = 60 mA; Tuned for 3 - 4 GHz band

Parameter	Test Conditions	Units	Min.	Typ.	Max.
Gain	$RF_{IN} - RF_{OUT}$, 3.5 GHz	dB	—	32	—
Noise Figure	$RF_{IN} - RF_{OUT}$, 3.5 GHz	dB	—	1.3	—
Input Return Loss	$RF_{IN} - RF_{OUT}$, 3.5 GHz	dB	—	12	—
Output Return Loss	$RF_{IN} - RF_{OUT}$, 3.5 GHz	dB	—	14	—

Typical Performance Curves: 3 - 4 GHz tuned Sample Board, $RF_{IN} - RF_{OUT}$

Gain

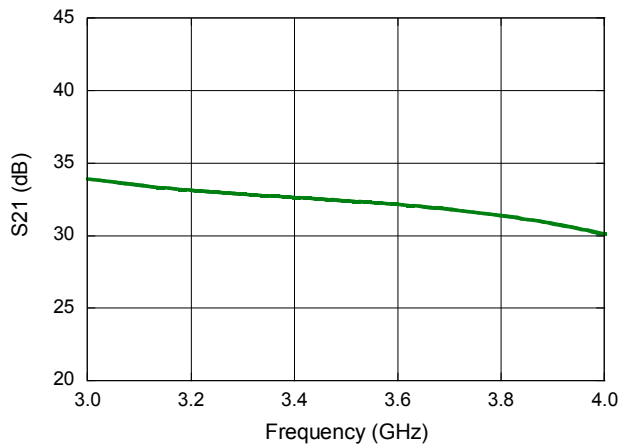

Noise Figure

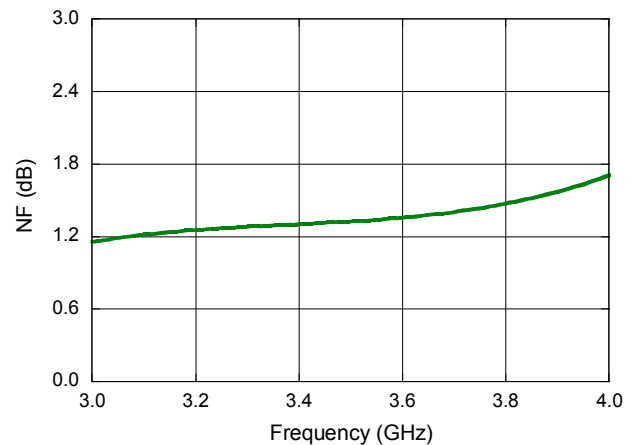

Input Return Loss

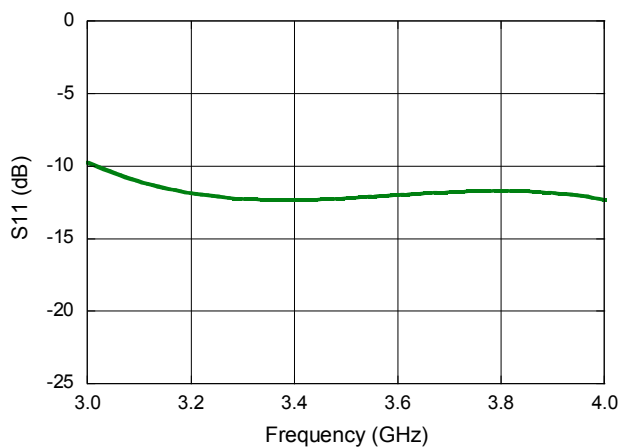

Output Return Loss

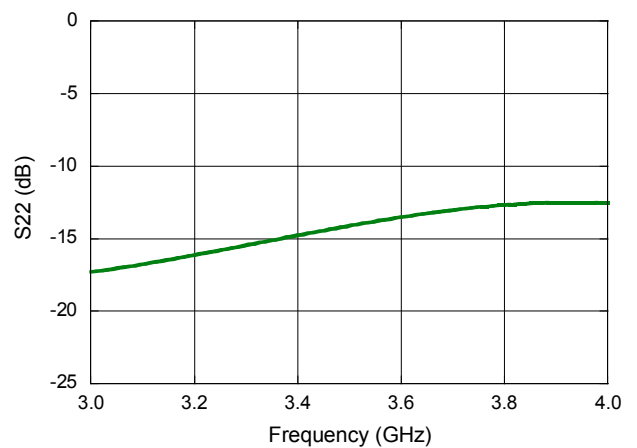

Sample Board - PCB Layout

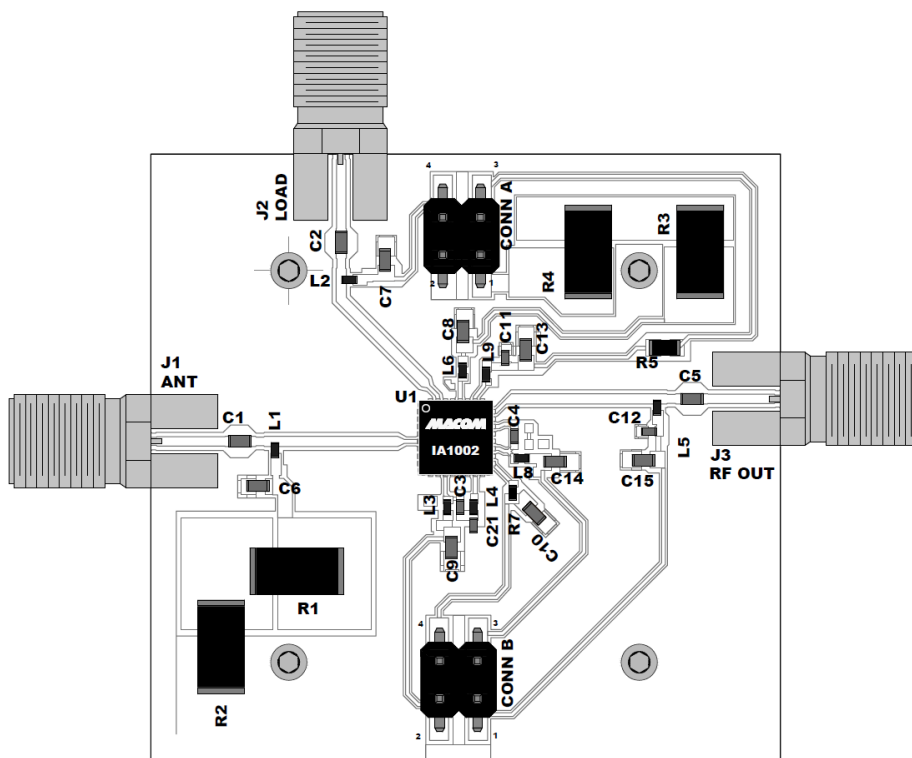

Sample Board Parts List* for 3 - 4 GHz Tuned PCB

Part	Value	Description	MFR Part #
C1, C2, C5	27 pF / 250 V	0603 SMT Capacitor	ATC600S270GT250T
C3	22 pF / 250 V	0402 SMT Capacitor	ATC600L220FT200T
C4	3.3 pF / 50 V	0402 SMT Capacitor	GRM1555C1H3R3BA01D
C6, C7, C8, C9, C10, C13, C14, C15	4.7 μ F / 35 V	0603 SMT Capacitor	-
C11	10 nF / 25V	0402 SMT Capacitor	-
C12	1 nF / 25V	0402 SMT Capacitor	-
C21	0.40 pF \pm 0.1 pF	0402 SMT Capacitor	GJM1555C1HR40BB01
L1, L2, L3, L5, L6, L9	68 nH / 100 mA	0402 SMT Inductor	0402CS-68NXJLW
L4	1.2 nH	0402 SMT Inductor	0402CS-1N2XJLU
L8	2.0 nH	0402 SMT Inductor	0402CS-2N0XJLU
R1, R2, R3, R4	133 Ω / 1.50 W	2512 SMT Resistor	-
R5	133 Ω	0805 SMT Resistor	-
R7	100 Ω	0402 SMT Resistor	-
J1 -J3	SMA END LAUNCH	RF CONNECTOR	142-0761-821
C16, C18, C19, C20, C22		do not populate	
* Aluminum heat sink mounted to backside of PCB is not shown			

Lead-Free 5 mm 32-Lead HQFN[†]

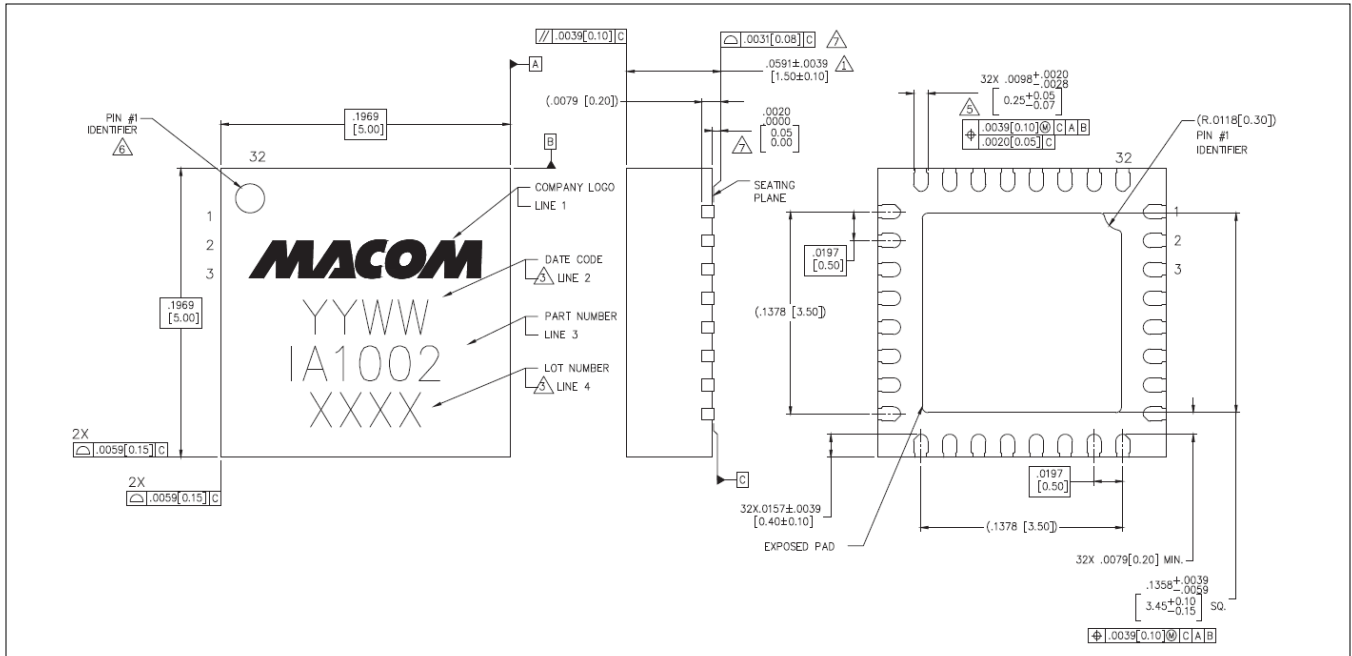

[†] Reference Application Note M538 for lead-free solder reflow recommendations.
Meets JEDEC moisture sensitivity level 1 requirements.
Plating is NiPdAuAg

M/A-COM Technology Solutions Inc. All rights reserved.

Information in this document is provided in connection with M/A-COM Technology Solutions Inc ("MACOM") products. These materials are provided by MACOM as a service to its customers and may be used for informational purposes only. Except as provided in MACOM's Terms and Conditions of Sale for such products or in any separate agreement related to this document, MACOM assumes no liability whatsoever. MACOM assumes no responsibility for errors or omissions in these materials. MACOM may make changes to specifications and product descriptions at any time, without notice. MACOM makes no commitment to update the information and shall have no responsibility whatsoever for conflicts or incompatibilities arising from future changes to its specifications and product descriptions. No license, express or implied, by estoppels or otherwise, to any intellectual property rights is granted by this document.

THESE MATERIALS ARE PROVIDED "AS IS" WITHOUT WARRANTY OF ANY KIND, EITHER EXPRESS OR IMPLIED, RELATING TO SALE AND/OR USE OF MACOM PRODUCTS INCLUDING LIABILITY OR WARRANTIES RELATING TO FITNESS FOR A PARTICULAR PURPOSE, CONSEQUENTIAL OR INCIDENTAL DAMAGES, MERCHANTABILITY, OR INFRINGEMENT OF ANY PATENT, COPYRIGHT OR OTHER INTELLECTUAL PROPERTY RIGHT. MACOM FURTHER DOES NOT WARRANT THE ACCURACY OR COMPLETENESS OF THE INFORMATION, TEXT, GRAPHICS OR OTHER ITEMS CONTAINED WITHIN THESE MATERIALS. MACOM SHALL NOT BE LIABLE FOR ANY SPECIAL, INDIRECT, INCIDENTAL, OR CONSEQUENTIAL DAMAGES, INCLUDING WITHOUT LIMITATION, LOST REVENUES OR LOST PROFITS, WHICH MAY RESULT FROM THE USE OF THESE MATERIALS.

MACOM products are not intended for use in medical, lifesaving or life sustaining applications. MACOM customers using or selling MACOM products for use in such applications do so at their own risk and agree to fully indemnify MACOM for any damages resulting from such improper use or sale.