

GaN Amplifier 50 V, 15 W

DC - 2.7 GHz



MAGX-100027-015S0P

Rev. V2

Features

- Suitable for Linear and Saturated Applications
- CW and Pulsed Operation: 15 W Output Power
- 260°C Reflow Compatible
- 50 V Operation
- 100% RF Tested
- RoHS* Compliant



6 x 3 mm DFN

Description

The MAGX-100027-015S0P is a high power GaN on Silicon HEMT D-mode transistor suitable for DC - 2.7 GHz frequency operation. The device supports both CW and pulsed operation with peak output power levels to 15 W (41.8 dBm) in a plastic package.

The MAGX-100027-015S0P is ideally suited for a multitude of applications including military radio communications, digital cellular infrastructure, RF energy, avionics, test instrumentation and RADAR.

Typical Performance:

- $V_{DS} = 50\text{ V}$, $I_{DQ} = 60\text{ mA}$, $T_C = 25^\circ\text{C}$.
Measured under pulsed load-pull at 2.5 dB Compression, 100 μs pulse width, 1 ms period, 10% duty cycle.

Frequency (GHz)	Output Power ¹ (dBm)	Gain ² (dB)	η_D^2 (%)
0.9	44.2	27.6	78.3
1.4	44.3	22.3	73.5
2.0	44.2	22.7	68.4
2.5	44.2	20.7	67.6
2.7	43.7	20.8	62

1. Load impedance tuned for maximum output power.
2. Load impedance tuned for maximum drain efficiency.

Ordering Information

Part Number	Package
MAGX-100027-015S0P	Bulk Quantity
MAGX-100027-015STP	Tape and Reel
MAGX-1A0027-015S0P	Sample Board

Functional Schematic

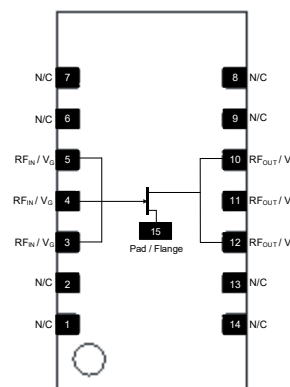

Pin Configuration

Pin #	Pin Name	Function
1, 2	NC	No Connection
3 - 5	RF _{IN} / V _G	RF Input / Gate
6 - 9	NC	No Connection
10 - 12	RF _{OUT} / V _D	RF Output / Drain
13, 14	NC	No Connection
15	Pad ³	Ground / Source

3. The exposed pad centered on the package bottom must be connected to RF, DC and thermal ground.

* Restrictions on Hazardous Substances, compliant to current RoHS EU directive.

GaN Amplifier 50 V, 15 W

DC - 2.7 GHz



MAGX-100027-015S0P

Rev. V2

RF Electrical Characteristics: $T_C = 25^\circ\text{C}$, $V_{DS} = 50\text{ V}$, $I_{DQ} = 60\text{ mA}$
Note: Performance in MACOM Evaluation Test Fixture, 50 Ω system

Parameter	Test Conditions	Symbol	Min.	Typ.	Max.	Units
Small Signal Gain	Pulsed ⁴ , 2.5 GHz	G_{SS}	-	17.6	-	dB
Power Gain	Pulsed ⁴ , 2.5 GHz, 2.5 dB Gain Compression	G_{SAT}	-	15.3	-	dB
Saturated Drain Efficiency	Pulsed ⁴ , 2.5 GHz, 2.5 dB Gain Compression	η_{SAT}	-	60	-	%
Saturated Output Power	Pulsed ⁴ , 2.5 GHz, 2.5 dB Gain Compression	P_{SAT}	-	44	-	dBm
Gain Variation (-25°C to +85°C)	Pulsed ⁴ 2.5 GHz	ΔG	-	0.02	-	dB/°C
Power Variation (-25°C to +85°C)	Pulsed ⁴ 2.5 GHz	$\Delta P_{2.5dB}$	-	0.012	-	dB/°C
Gain	Pulsed ⁴ , 2.5 GHz, $P_{OUT} = 42.8\text{ dBm}$	G_P	-	17.2	-	dB
Drain Efficiency	Pulsed ⁴ , 2.5 GHz, $P_{OUT} = 42.8\text{ dBm}$	η	-	52	-	%
Ruggedness: Output Mismatch	All phase angles	Ψ	VSWR = 10:1, No Device Damage			

RF Electrical Specifications: $T_A = 25^\circ\text{C}$, $V_{DS} = 50\text{ V}$, $I_{DQ} = 60\text{ mA}$
Note: Performance in MACOM Production Test Fixture, 50 Ω system

Parameter	Test Conditions	Symbol	Min.	Typ.	Max.	Units
Power Gain	Pulsed ⁴ , 2.5 GHz, 2.5 dB Gain Compression	G_{SAT}	10.5	13.2	-	dB
Saturated Drain Efficiency	Pulsed ⁴ , 2.5 GHz, 2.5 dB Gain Compression	η_{SAT}	53	59.6	-	%
Saturated Output Power	Pulsed ⁴ , 2.5 GHz, 2.5 dB Gain Compression	P_{SAT}	42.9	44.0	-	dBm
Gain	Pulsed ⁴ , 2.5 GHz, $P_{IN} = 27.5\text{ dBm}$	G_P	12.4	15.0	-	dB
Drain Efficiency	Pulsed ⁴ , 2.5 GHz, $P_{IN} = 27.5\text{ dBm}$	η	42.5	49.0	-	%

4. Pulse details: 100 μs pulse width, 1 ms period, 10% Duty Cycle.

DC Electrical Characteristics $T_A = 25^\circ\text{C}$

Parameter	Test Conditions	Symbol	Min.	Typ.	Max.	Units
Drain-Source Leakage Current	$V_{GS} = -8\text{ V}$, $V_{DS} = 130\text{ V}$	I_{DLK}	-	-	3.3	mA
Gate-Source Leakage Current	$V_{GS} = -8\text{ V}$, $V_{DS} = 0\text{ V}$	I_{GLK}	-	-	3.3	mA
Gate Threshold Voltage	$V_{DS} = 50\text{ V}$, $I_D = 3.3\text{ mA}$	V_T	-	-2.0	-	V
Gate Quiescent Voltage	$V_{DS} = 50\text{ V}$, $I_D = 60\text{ mA}$	V_{GSQ}	-2.4	-1.8	-1.4	V
On Resistance	$V_{GS} = 2\text{ V}$, $I_D = 23.1\text{ mA}$	R_{ON}	-	1.5	-	Ω
Maximum Drain Current	$V_{DS} = 7\text{ V}$ pulsed, pulse width 300 μs	$I_{D,MAX}$	-	1.93	-	A

Absolute Maximum Ratings^{5,6,7,8,9}

Parameter	Absolute Maximum
Drain Source Voltage, V_{DS}	130 V
Gate Source Voltage, V_{GS}	-10 to 3 V
Gate Current, I_G	10 mA
Storage Temperature Range	-65°C to +150°C
Case Operating Temperature Range	-40°C to +85°C
Channel Operating Temperature Range, T_{CH}	-40°C to +225°C
Absolute Maximum Channel Temperature	+250°C

5. Exceeding any one or combination of these limits may cause permanent damage to this device.
6. MACOM does not recommend sustained operation above maximum operating conditions.
7. Operating at drain source voltage $V_{DS} < 55$ V will ensure $MTTF > 1 \times 10^7$ hours.
8. Operating at nominal conditions with $T_{CH} \leq 225^\circ\text{C}$ will ensure $MTTF > 1 \times 10^7$ hours.
9. MTTF may be estimated by the expression $MTTF \text{ (hours)} = A e^{[B + C/(T+273)]}$ where T is the channel temperature in degrees Celsius, $A = 3.686$, $B = -35.00$, and $C = 25,416$.

Thermal Characteristics¹⁰

Parameter	Test Conditions	Symbol	Typical	Units
Thermal Resistance using Finite Element Analysis	$V_{DS} = 50$ V, $P_D = 13$ W, $T_{CASE} = 85^\circ\text{C}$, $T_{CH} = 225^\circ\text{C}$	$R_{\theta}(\text{FEA})$	7.7	°C/W
Thermal Resistance using Infrared Measurement of Die Surface Temperature	$V_{DS} = 50$ V, $P_D = 13.5$ W, $T_{CASE} = 85^\circ\text{C}$, $T_{CH} = 225^\circ\text{C}$	$R_{\theta}(\text{IR})$	8.9	°C/W

10. Case temperature measured using thermocouple embedded in heat-sink. Contact local applications support team for more details on this measurement.

Handling Procedures

Please observe the following precautions to avoid damage:

Static Sensitivity

Gallium Nitride Circuits are sensitive to electrostatic discharge (ESD) and can be damaged by static electricity. Proper ESD control techniques should be used when handling these HBM Class 1A, CDM Class C2B devices.

**Pulsed⁴ Load-Pull Performance
Reference Plane at Device Leads**

Frequency (GHz)	Z_{SOURCE} (Ω)	Maximum Output Power					
		$V_{DS} = 50\text{ V}, I_{DQ} = 60\text{ mA}, T_C = 25^\circ\text{C}, P_{2.5dB}$					
		Z_{LOAD}^1 (Ω)	Gain (dB)	P_{OUT} (dBm)	P_{OUT} (W)	η_D (%)	AM/PM ¹¹ (°)
0.9	5 + j13.8	38.2 + j21.2	26.7	44.2	26.3	66	0.5
1.4	5 + j8.6	27.4 + j15	21.2	44.3	26.9	57.9	0.1
2.0	5 + j4.7	22.7 + j13.8	18.2	44.2	26.3	57.7	-0.5
2.5	5 + j1.5	14.1 + j13.9	19.2	44.2	26.3	58.6	1.6
2.7	5 + j0.2	13.1 + j14.5	19.1	43.7	23.4	55	1.3

Frequency (GHz)	Z_{SOURCE} (Ω)	Maximum Drain Efficiency					
		$V_{DS} = 50\text{ V}, I_{DQ} = 60\text{ mA}, T_C = 25^\circ\text{C}, P_{2.5dB}$					
		Z_{LOAD}^2 (Ω)	Gain (dB)	P_{OUT} (dBm)	P_{OUT} (W)	η_D (%)	AM/PM ¹¹ (°)
0.9	5 + j13.8	38.4 + j50.8	27.6	42.9	19.5	78.3	1.2
1.4	5 + j8.6	14.2 + j32.7	22.3	42.2	16.6	73.5	1.3
2.0	5 + j4.7	11.6 + j23.2	22.7	42.5	17.8	68.4	2.2
2.5	5 + j1.5	8.2 + j20.4	20.7	42.7	18.6	67.6	1.0
2.7	5 + j0.2	7.5 + j18.8	20.8	42.4	17.4	62	1.3

Impedance Reference

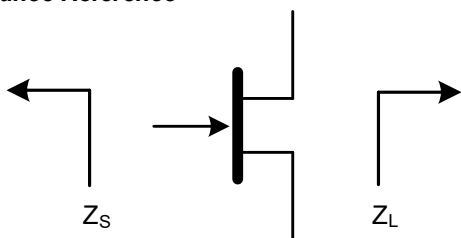

Z_{SOURCE} = Measured impedance presented to the input of the device at package reference plane.

Z_{LOAD} = Measured impedance presented to the output of the device at package reference plane.

11. AM/PM listed are relative values.

**Pulsed⁴ Load-Pull Performance
2.5 GHz**

P2.5dB Loadpull Output Power Contours (dBm)

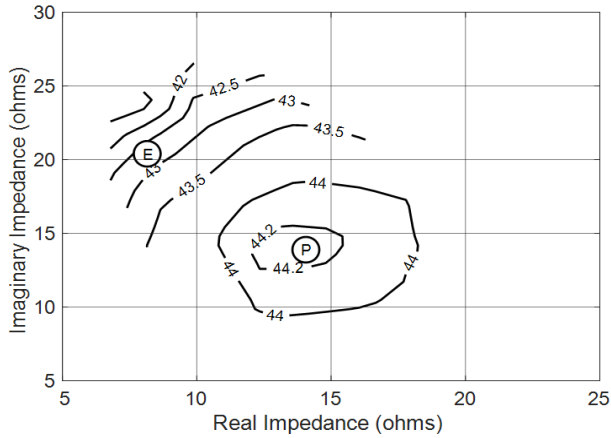

P2.5dB Loadpull Drain Efficiency Contours (%)

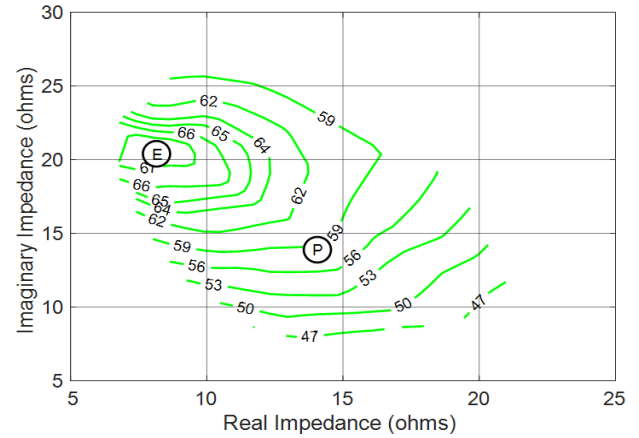

P2.5dB Loadpull Gain Contours (dB)

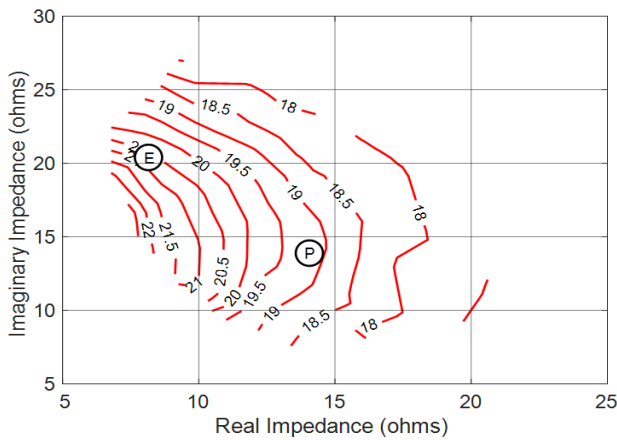

P2.5dB Loadpull AM/PM Contours (°)

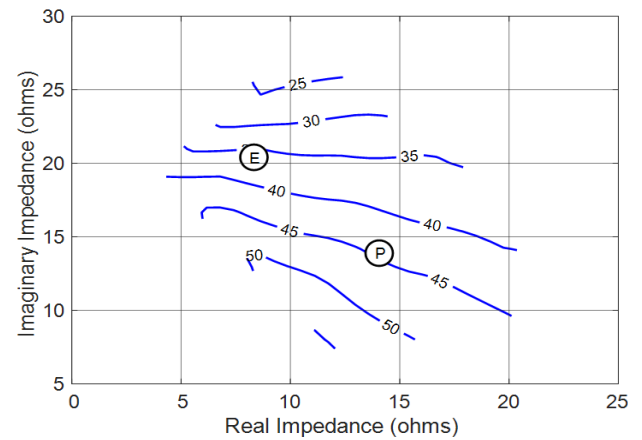

Gain vs. Output Power

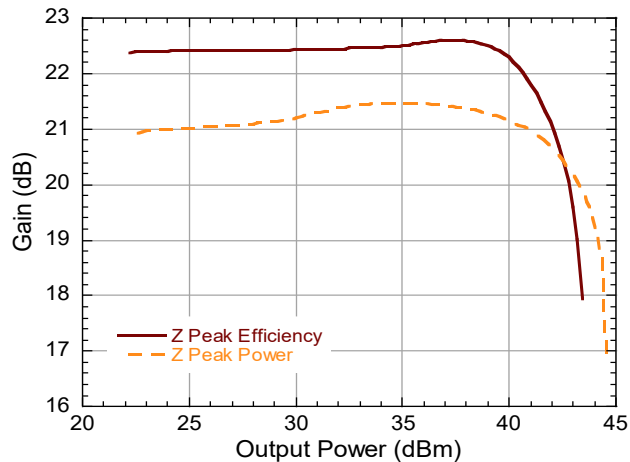

Drain Efficiency vs. Output Power

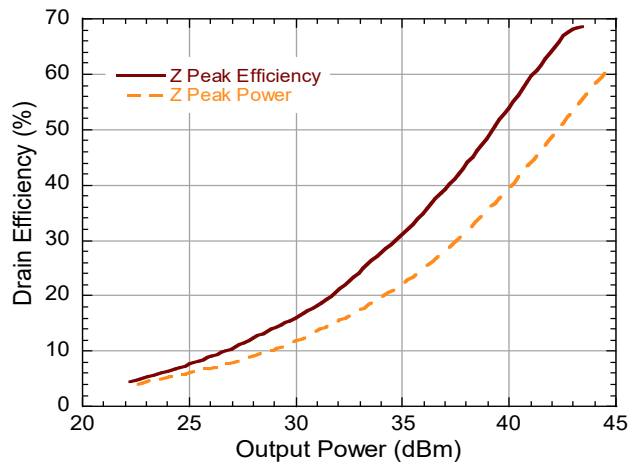

Evaluation Test Fixture and Recommended Tuning Solution 2.45 - 2.55 GHz

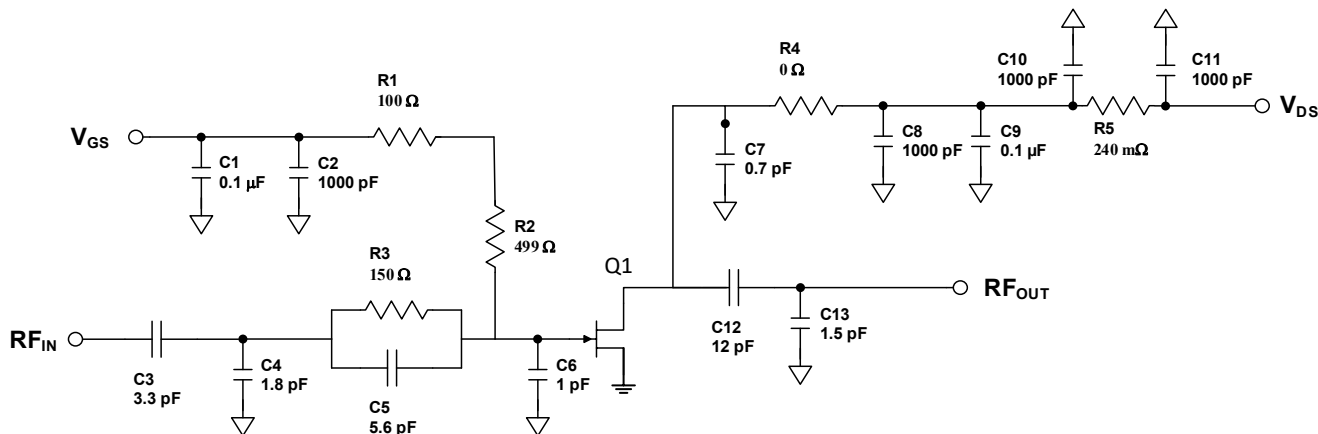

Description

Parts measured on evaluation board (20-mil thick RO4350). Matching is provided using a combination of lumped elements and transmission lines as shown in the simplified schematic above. Recommended tuning solution component placement, transmission lines, and details are shown on the next page.

Bias Sequencing

Turning the device ON

1. Set V_{GS} to the pinch-off (V_P).
2. Turn on V_{DS} to nominal Voltage (50 V).
3. Increase V_{GS} until I_{DSQ} current is reached.
4. Apply RF power to desired level.

Turning the device OFF

1. Turn the RF power off.
2. Decrease V_{GS} down to V_P pinch-off.
3. Decrease V_{DS} down to 0 V.
4. Turn off V_{GS} .

Evaluation Test Fixture and Recommended Tuning Solution 2.45 - 2.55 GHz

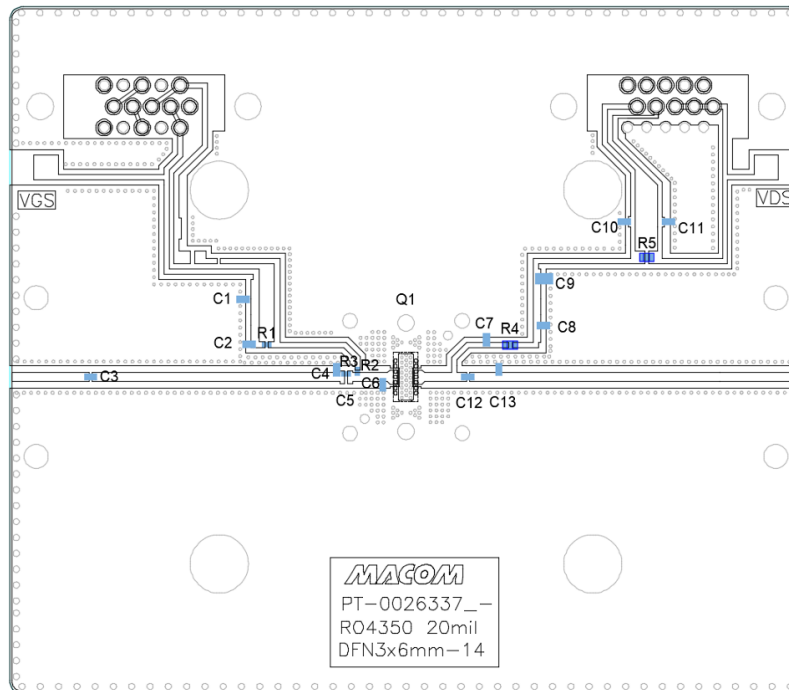

Parts List

Reference Designator	Value	Tolerance	Manufacturer	Part Number
C1, C9	0.1 μ F	5 %	Murata	GCJ188R72A104KA01D
C2, C10, C11	1000 pF	+/- 0.1 pF	Murata	GCJ188R92A102KA01D
C3	3.3 pF	+/- 0.1 pF	PPI	0603N3R3BL250
C4	1.8 pF	+/- 0.1 pF	PPI	0603N1R8BL250
C5	5.6 pF	+/- 0.1 pF	PPI	0402N5R6BL250
C6	1 pF	+/- 0.1 pF	PPI	0603N1R0BL250
C7	0.7 pF	+/- 0.1 pF	PPI	0603N0R7BL250
C8	1000 pF	5 %	Murata	GRM21AR72E102KW01D
C12	12 pF	+/- 5%	PPI	0603N120BL250
C13	1.5 pF	+/- 0.1 pF	PPI	0603N1R5BL250
R1	100 Ω	1%	Panasonic	ERJ-PA2F1000X
R2	499 Ω	1%	Viking	CR-02FL6—499R
R3	150 Ω	1%	Vishay Dale	CRCW0402150RFKEDHP
R4	0 Ω	1%	Vishay Dale	CRCW06030000Z0EBC
R5	240 m Ω	1%	Vishay Dale	RCWE1210R240FKEA
Q1	15 W	-	MACOM	MAGX-100027-015S0P
PCB	Rogers RO4350, 20mil, 1oz Cu, Au Finish			

Typical Performance Curves as Measured in the 2.45 - 2.55 GHz Evaluation Test Fixture:
Pulsed⁴ 2.5 GHz, $V_{DS} = 50\text{ V}$, $I_{DQ} = 60\text{ mA}$, $T_C = 25^\circ\text{C}$
Unless Otherwise Noted

Gain vs. Output Power

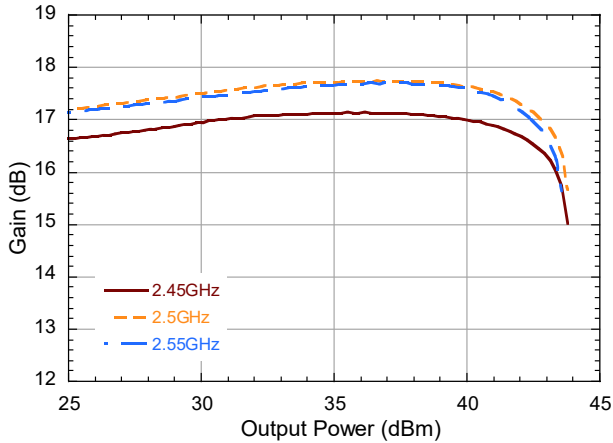

Drain Efficiency vs. Output Power

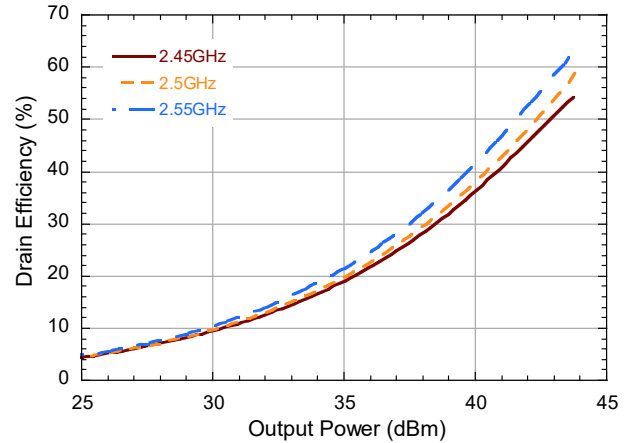

Gain vs. Output Power and V_{DS}

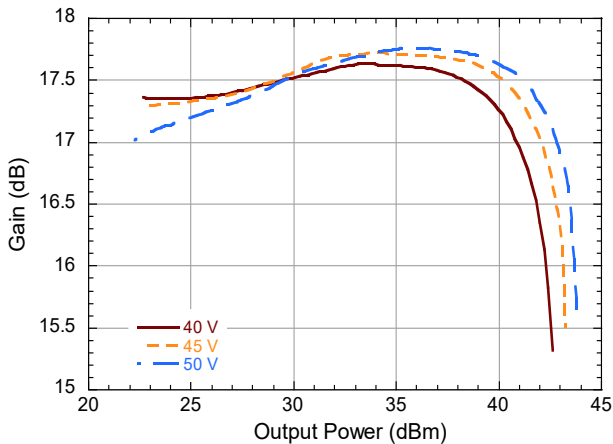

Drain Efficiency vs. Output Power and V_{DS}

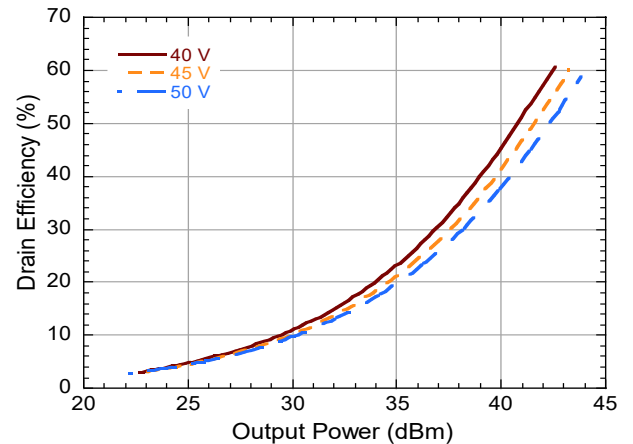

Gain vs. Output Power and I_{DQ}

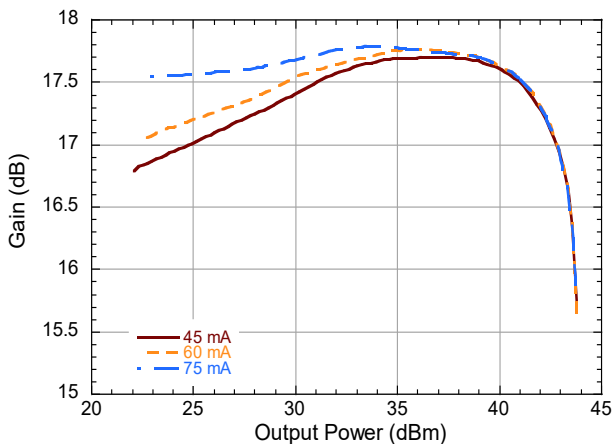

Drain Efficiency vs. Output Power and I_{DQ}

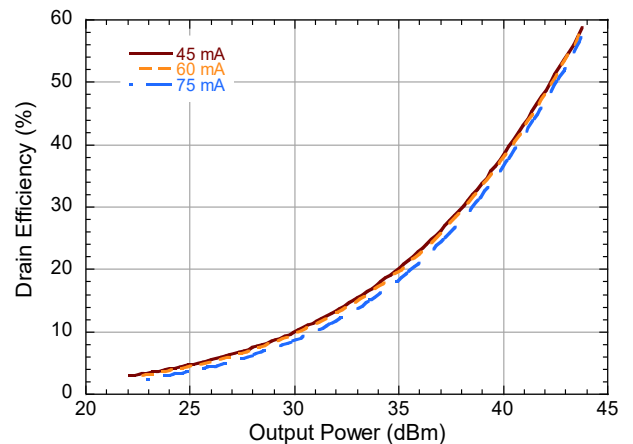

**Typical Performance Curves as Measured in the 2.45 - 2.55 GHz Evaluation Test Fixture:
Pulsed⁴ 2.5 GHz, $V_{DS} = 50$ V, $I_{DQ} = 60$ mA, $T_C = 25^\circ\text{C}$
Unless Otherwise Noted**

Gain vs. Output Power and T_c

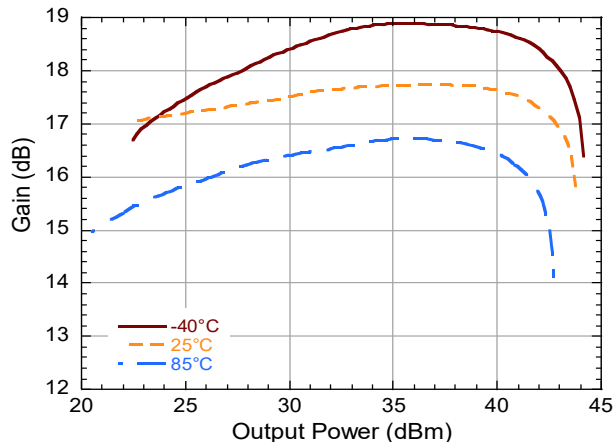

Drain Efficiency vs. Output Power and T_c

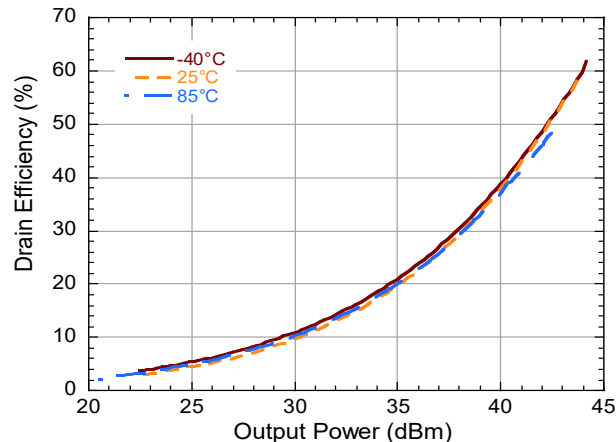

Gain vs. Frequency, 2.5 dB Gain Compression

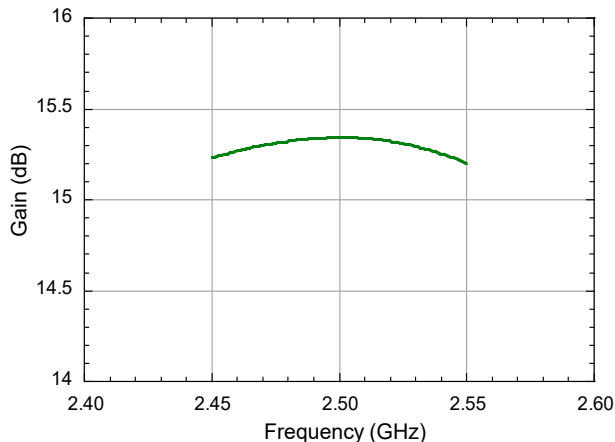

Drain Efficiency vs. Frequency, 2.5 dB Gain Compression

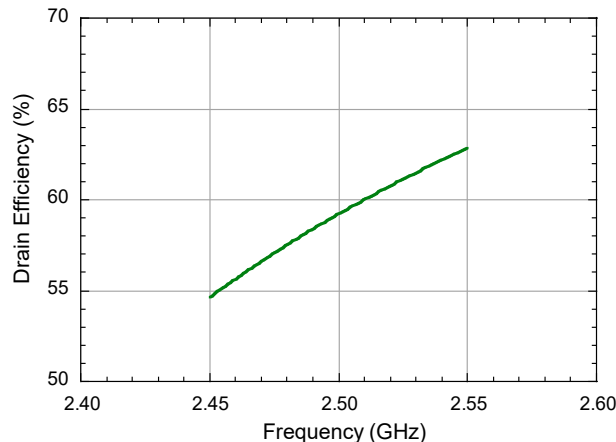

Output Power vs. Frequency, 2.5 dB Gain Compression

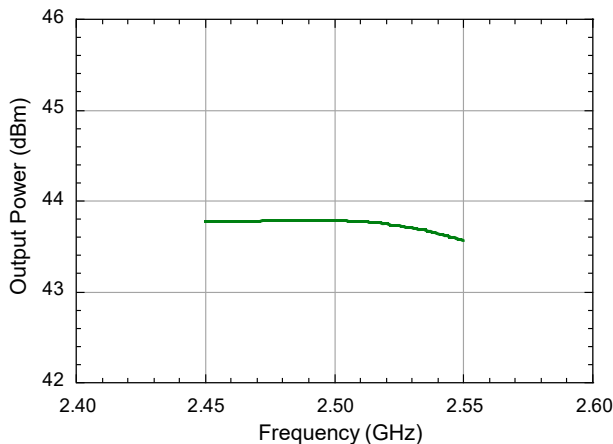

MACOM Technology Solutions Inc. ("MACOM"). All rights reserved.

These materials are provided in connection with MACOM's products as a service to its customers and may be used for informational purposes only. Except as provided in its Terms and Conditions of Sale or any separate agreement, MACOM assumes no liability or responsibility whatsoever, including for (i) errors or omissions in these materials; (ii) failure to update these materials; or (iii) conflicts or incompatibilities arising from future changes to specifications and product descriptions, which MACOM may make at any time, without notice. These materials grant no license, express or implied, to any intellectual property rights.

THESE MATERIALS ARE PROVIDED "AS IS" WITH NO WARRANTY OR LIABILITY, EXPRESS OR IMPLIED, RELATING TO SALE AND/OR USE OF MACOM PRODUCTS INCLUDING FITNESS FOR A PARTICULAR PURPOSE, MERCHANTABILITY, INFRINGEMENT OF INTELLECTUAL PROPERTY RIGHT, ACCURACY OR COMPLETENESS, OR SPECIAL, INDIRECT, INCIDENTAL, OR CONSEQUENTIAL DAMAGES WHICH MAY RESULT FROM USE OF THESE MATERIALS.

MACOM products are not intended for use in medical, lifesaving or life sustaining applications. MACOM customers using or selling MACOM products for use in such applications do so at their own risk and agree to fully indemnify MACOM for any damages resulting from such improper use or sale.