

GaN Amplifier 48 V, 10 W

3.4 - 4.0 GHz



MAGB-103440-010B0P

Rev. V2

Features

- Suitable for Linear & Saturated Applications
- Optimized for Cellular Base Station Applications
- Designed for Digital Predistortion Error Correction Systems
- High Terminal Impedances for Broadband Performance
- 48 V Operation
- 100% RF Tested
- RoHS* Compliant

Description

The MAGB-103440-010B0P GaN HEMT is a wideband GaN HEMT D-mode amplifier designed for base station applications and optimized for 3.4 - 4.0 GHz modulated signal operation. This device supports pulsed and linear operation with peak output power levels to 10 W (40 dBm) in a 4 mm DFN package.

Typical Performance:

- $V_{DS} = 48\text{ V}$, $I_{DQ} = 25\text{ mA}$, $T_C = 25^\circ\text{C}$.
Measured under load-pull at 2.5 dB Compression, 100 μs pulse width, 10% duty cycle.

Frequency (GHz)	Output Power ¹ (dBm)	Gain ² (dB)	η_D ² (%)
3.4	40.6	18.9	66.9
3.6	40.6	18.7	62.3
3.8	40.6	18.6	61.8
4.0	40.5	18.2	60.3

1. Load impedance tuned for maximum output power.
2. Load impedance tuned for maximum drain efficiency.

Ordering Information

Part Number	Package
MAGB-103440-010B0P	Bulk Quantity
MAGB-103440-010BTP	Tape and Reel
MAGB-1B3440-010B0P	Class-AB Sample Board



4 mm DFN

Functional Schematic

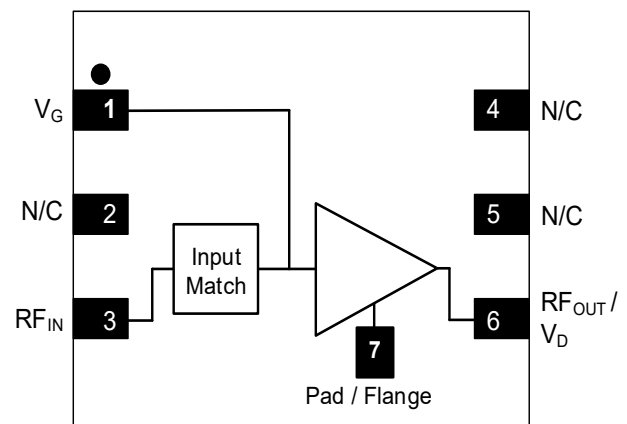

Pin Configuration³

Pin #	Pin Name	Function
1	V_G	Gate
2,4,5	N/C	No Connection
3	RF_{IN}	RF Input
6	RF_{OUT} / V_D	RF Output / Drain
7	Pad ³	Ground / Source

3. The pad on the package bottom must be connected to RF, DC or thermal ground.

¹ * Restrictions on Hazardous Substances, compliant to current RoHS EU directive.

RF Electrical Characteristics: $T_C = 25^\circ\text{C}$, $V_{DS} = 48\text{V}$, $I_{DQ} = 25\text{ mA}$
(Performance in MACOM Single-ended Class-AB Evaluation Circuit, 50 Ω system)

Parameter	Test Conditions	Symbol	Min.	Typ.	Max.	Units
Small Signal Gain	Pulsed ⁴ , 3.8 GHz	G_{SS}	-	18.1	-	dB
Saturated Output Power	Pulsed ⁴ , 3.8 GHz	P_{SAT}	-	39.6	-	dBm
Drain Efficiency at Saturation	Pulsed ⁴ , 3.8 GHz	η_{SAT}	-	53.7	-	%
AM/PM	Pulsed ⁴ , 3.8 GHz	Φ	-	-4	-	°
Modulated Peak Power	WCDMA ⁵ , 3.8 GHz	$P_{2.5dB}^6$	-	39.4	-	dBm
Gain Flatness in 60MHz	WCDMA ⁵ , $P_{OUT} = 28\text{ dBm}$	G_F	-	0.5	-	dB
Gain Variation (-25°C to +105°C)	WCDMA ⁵ , 3.8 GHz, $P_{OUT} = 28\text{ dBm}$	ΔG	-	0.02	-	dB/°C
Power Variation (-25°C to +105°C)	Pulsed ⁴ , 3.8 GHz	$\Delta P_{2.5dB}$	-	0.01	-	dBm/°C
Power Gain	WCDMA ⁵ , 3.8 GHz, $P_{OUT} = 28\text{ dBm}$	G_P	-	17.7	-	dB
Drain Efficiency	WCDMA ⁵ , 3.8 GHz, $P_{OUT} = 28\text{ dBm}$	η	-	18.3	-	%
Output CCDF @ 0.01%	WCDMA ⁵ , 3.8 GHz, $P_{OUT} = 28\text{ dBm}$	PAR	-	9.6	-	dB
Adjacent Channel Power	WCDMA ⁵ , 3.8 GHz, $P_{OUT} = 28\text{ dBm}$	ACP	-	-45	-	dBc
Input Return Loss	WCDMA ⁵ , 3.8 GHz, $P_{OUT} = 28\text{ dBm}$	IRL	-	-7	-	dB
Ruggedness: Output Mismatch	All phase angles	Ψ	VSWR = 10:1, No Device Damage			

RF Electrical Characteristics: $T_A = 25^\circ\text{C}$, $V_{DS} = 48\text{V}$, $I_{DQ} = 25\text{ mA}$
(Performance in MACOM Single-ended Class-AB Production Test Fixture, 50 Ω system)

Parameter	Test Conditions	Symbol	Min.	Typ.	Max.	Units
Power Gain	WCDMA ⁵ , 3.85 GHz, $P_{OUT} = 32\text{ dBm}$	G_P	15	16.7	-	dB
Drain Efficiency	WCDMA ⁵ , 3.85 GHz, $P_{OUT} = 32\text{ dBm}$	η	22	27.4	-	%
Output CCDF @ 0.01%	WCDMA ⁵ , 3.85 GHz, $P_{OUT} = 32\text{ dBm}$	PAR	7.5	7.9	-	dB
Adjacent Channel Power	WCDMA ⁵ , 3.85 GHz, $P_{OUT} = 32\text{ dBm}$	ACP	-	-38	-35	dBc
Input Return Loss	WCDMA ⁵ , 3.85 GHz, $P_{OUT} = 32\text{ dBm}$	IRL	-	-7	-3	dB

DC Electrical Characteristics: $T_C = 25^\circ\text{C}$

Parameter	Test Conditions	Symbol	Min.	Typ.	Max.	Units
Drain-Source Leakage Current	$V_{GS} = -8\text{ V}$, $V_{DS} = 130\text{ V}$	I_{DLK}	-	-	1.28	mA
Gate-Source Leakage Current	$V_{GS} = -8\text{ V}$, $V_{DS} = 0\text{ V}$	I_{GLK}	-	-	-1.28	mA
Gate Threshold Voltage	$V_{DS} = 48\text{ V}$, $I_D = 1.28\text{ mA}$	V_T	-2.6	-2.4	-	V
Gate Quiescent Voltage	$V_{DS} = 48\text{ V}$, $I_D = 25\text{ mA}$	V_{GSQ}	-2.5	-1.9	-	V
On Resistance	$V_{GS} = 2\text{ V}$, $I_D = 12.8\text{ mA}$	R_{ON}	-	3.2	-	Ω
Maximum Drain Current	$V_{DS} = 7\text{ V}$, pulse width 300 μs	$I_{D, MAX}$	-	0.8	-	A

4. Pulse details: 100 μs pulse width, 1 ms period, 10% Duty Cycle

5. Modulated Signal: 3.84MHz, WCDMA 3GPP TM1 64 DPCH, 9.9dB PAR @ 0.01% CCDF

6. $P_{2.5dB} = P_{OUT} + 7.5\text{ dB}$ where P_{OUT} is the average output power measured using a modulated signal⁵ where the output PAR is compressed to 7.5 dB @ 0.01% probability CCDF.

Absolute Maximum Ratings^{7,8,9,10,11}

Parameter	Absolute Maximum
Drain Source Voltage, V_{DS}	130 V
Gate Source Voltage, V_{GS}	-10 to 3 V
Gate Current, I_G	2.56 mA
Storage Temperature Range	-65°C to +150°C
Case Operating Temperature Range	-40°C to +120°C
Channel Operating Temperature Range, T_{CH}	-40°C to +210°C
Absolute Maximum Channel Temperature	+225°C

7. Exceeding any one or combination of these limits may cause permanent damage to this device.
8. MACOM does not recommend sustained operation above maximum operating conditions.
9. Operating at drain source voltage $V_{DS} < 55$ V will ensure $MTTF > 4 \times 10^6$ hours.
10. Operating at nominal conditions with $T_{CH} \leq 210^\circ\text{C}$ will ensure $MTTF > 4 \times 10^6$ hours.
11. MTTF may be estimated by the expression $MTTF$ (hours) = $A e^{[B + C/(T+273)]}$ where T is the channel temperature in degrees Celsius, $A = 1.76$, $B = -33.83$, and $C = 23,476$.

Thermal Characteristics¹²

Parameter	Test Conditions	Symbol	Typical	Units
Thermal Resistance using Finite Element Analysis	$V_{DS} = 48$ V, $T_C = 85^\circ\text{C}$, $T_{CH} = 225^\circ\text{C}$	$R_{\theta}(\text{FEA})$	21.2	°C/W
Thermal Resistance using Infrared Measurement of Die Surface Temperature	$V_{DS} = 48$ V, $T_C = 85^\circ\text{C}$, $T_{CH} = 225^\circ\text{C}$	$R_{\theta}(\text{IR})$	16.2	°C/W

12. Case temperature measured using thermocouple embedded in heat-sink. Contact local applications support team for more details on this measurement.

Handling Procedures

Please observe the following precautions to avoid damage:

Static Sensitivity

Gallium Nitride Circuits are sensitive to electrostatic discharge (ESD) and can be damaged by static electricity. Proper ESD control techniques should be used when handling these HBM Class 1A, CDM Class 3 devices.

Pulsed⁴ Load-Pull Performance
Reference Plane at Device Leads

Frequency (GHz)	Z_{SOURCE} (Ω)	Maximum Output Power					
		$V_{DS} = 48\text{ V}, I_{DQ} = 25\text{ mA}, T_C = 25^\circ\text{C}, P_{2.5dB}$					
		Z_{LOAD}^{13} (Ω)	Gain (dB)	P_{OUT} (dBm)	P_{OUT} (W)	η_D (%)	AM/PM ($^\circ$)
3.4	11.6 - j53.2	23.7 + j6.2	17.9	40.6	11.5	55.6	-31.1
3.6	21.7 - j60.9	23.5 + j6.2	17.4	40.6	11.5	56.9	-46.2
3.8	39.9 - j65.6	21.4 + j1.6	16.8	40.6	11.5	55.1	-60.5
4.0	63.4 - j36.6	21.7 + j0.6	16.6	40.5	11.2	55.1	-87.2

Frequency (GHz)	Z_{SOURCE} (Ω)	Maximum Drain Efficiency					
		$V_{DS} = 48\text{ V}, I_{DQ} = 25\text{ mA}, T_C = 25^\circ\text{C}, P_{2.5dB}$					
		Z_{LOAD}^{14} (Ω)	Gain (dB)	P_{OUT} (dBm)	P_{OUT} (W)	η_D (%)	AM/PM ($^\circ$)
3.4	13.1 - j57.7	16.8 + j13.7	18.9	40.4	11.0	66.9	-34.1
3.6	26.2 - j68.9	13.6 + j12.4	18.7	39.4	8.7	62.3	-51.0
3.8	54.5 - j69.3	12.4 + j8.0	18.6	39.4	8.7	61.8	-66.0
4.0	78.0 - j17.8	10.4 + j4.7	18.2	39.2	8.3	60.3	-92.1

Impedance Reference

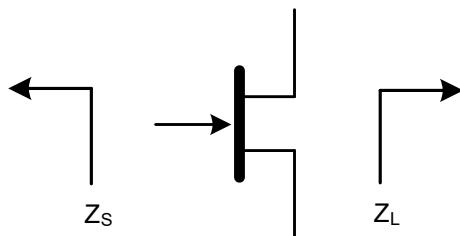

Z_{SOURCE} = Measured impedance presented to the input of the device at package reference plane.

Z_{LOAD} = Measured impedance presented to the output of the device at package reference plane.

13. Load impedance for optimum output power.

14. Load impedance for optimum efficiency.

Pulsed⁴ Load-Pull Performance @ 3.8 GHz

P2.5dB Loadpull Output Power Contours (dBm)

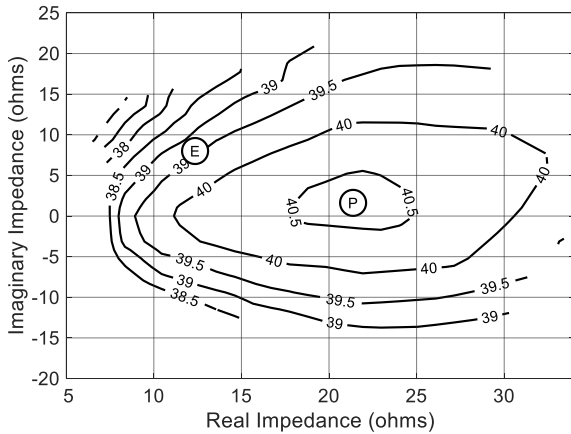

P2.5dB Loadpull Drain Efficiency Contours (%)

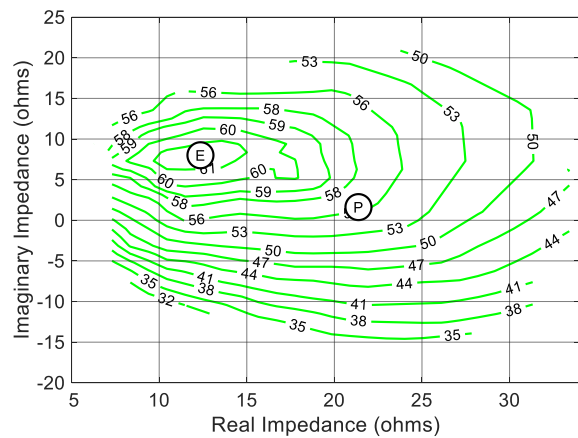

P2.5dB Loadpull Gain Contours (dB)

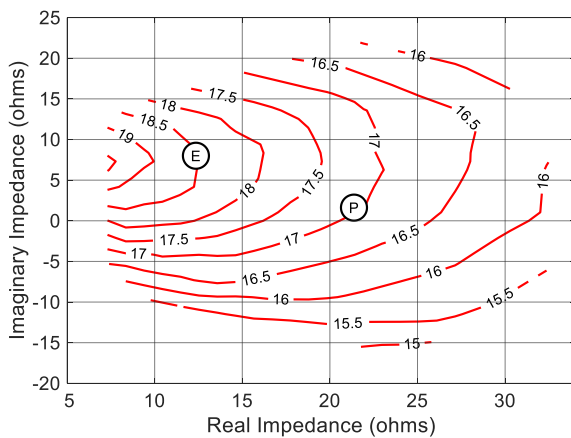

P2.5dB Loadpull AM/PM Contours (°)

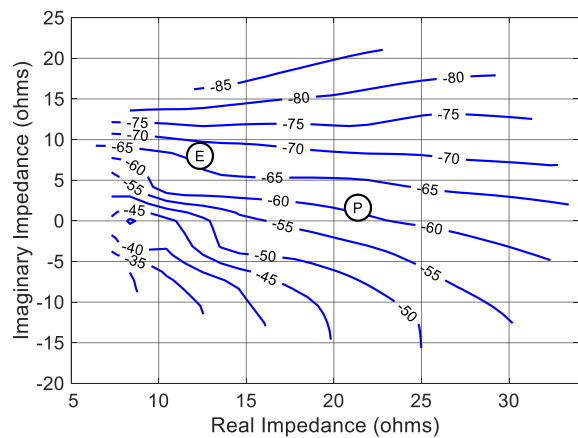

Gain vs. Output Power

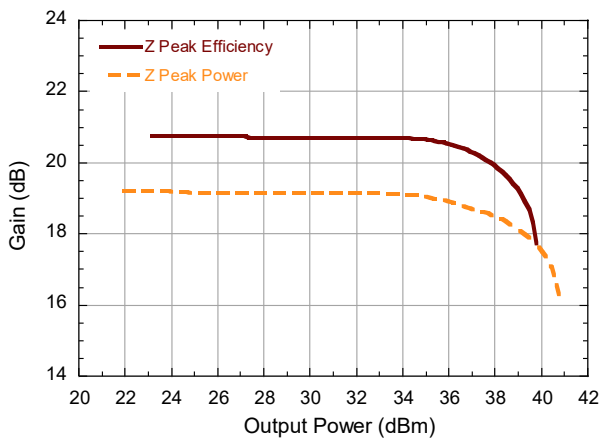

Drain Efficiency vs. Output Power

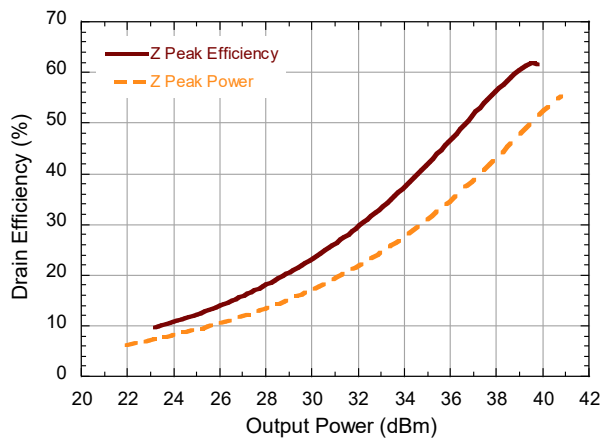

Evaluation Test Fixture and Recommended Tuning Solution 3.4 - 3.8 GHz

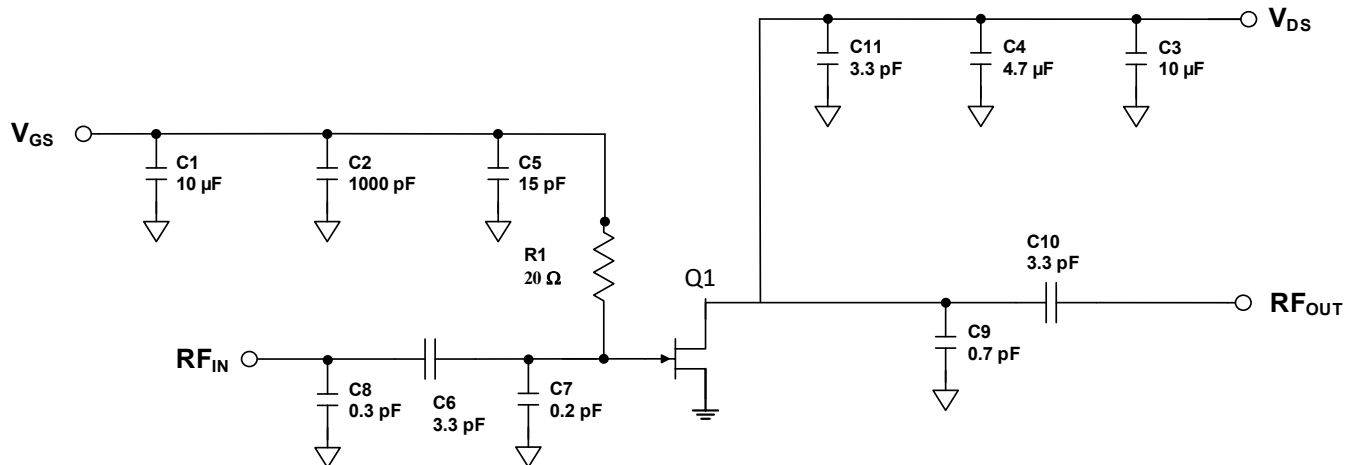

Description

Parts measured on evaluation board (20-mil thick RO4350). Matching is provided using a combination of lumped elements and transmission lines as shown in the simplified schematic above. Recommended tuning solution component placement, transmission lines, and details are shown on the next page.

Bias Sequencing

Turning the device ON

1. Set V_{GS} to pinch-off (V_P).
2. Turn on V_{DS} to nominal voltage (48 V).
3. Increase V_{GS} until I_{DS} current is reached.
4. Apply RF power to desired level.

Turning the device OFF

1. Turn the RF power OFF.
2. Decrease V_{GS} down to V_P pinch-off.
3. Decrease V_{DS} down to 0 V.
4. Turn off V_{GS} .

Evaluation Board and Recommended Tuning Solution 3.4 - 3.8 GHz

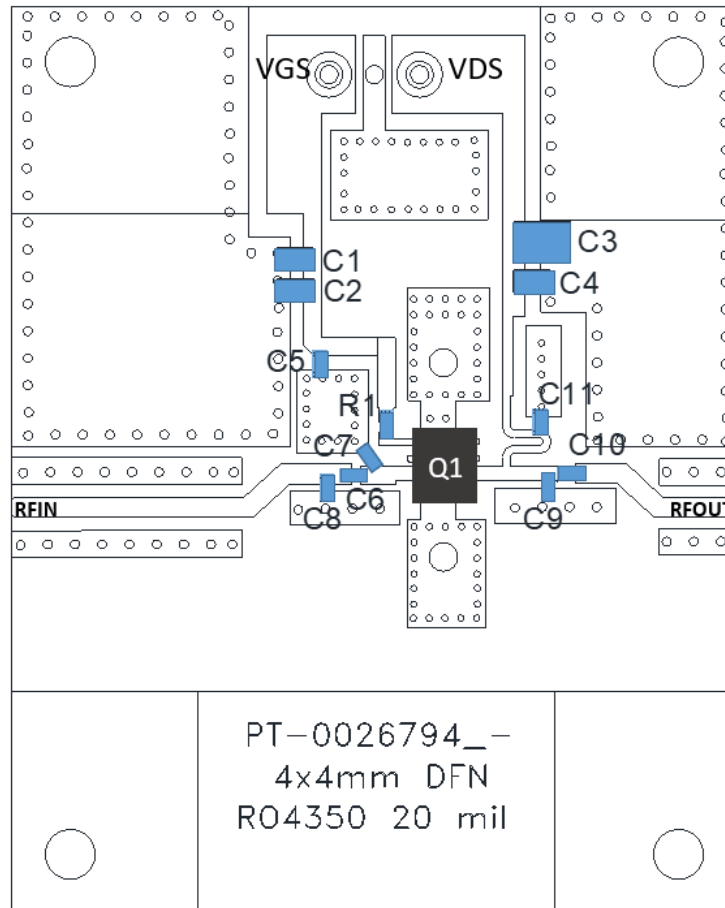

Reference Designator	Value	Tolerance	Manufacturer	Part Number
C1	10 μ F	+/- 20%	TDK Corporation	C2012X5R1C106M085AC
C2	1000 pF	+/- 10%	KEMET	C0805C102K2RACTU
C3	10 μ F	+/- 10%	Murata	GRM32EC72A106KE05L
C4	4.7 μ F	+/- 10%	Murata	GRM21BC81H475KE11L
C5	15 pF	+/- 5%	Murata	GQM1875C2E150JB12D
C6, C10, C11	3.3 pF	+/- 0.1 pF	Murata	GQM1875C2E3R3BB12D
C7	0.2 pF	+/- 0.1 pF	Murata	GQM1875C2ER20BB12D
C8	0.3 pF	+/- 0.1 pF	Murata	GQM1875C2ER30BB12D
C9	0.7 pF	+/- 0.1 pF	Murata	GQM1875C2ER70BB12D
R1	20 Ω	+/- 0.5%	Yageo	RT0805DRE0720RL
Q1			MACOM	MAGB-103440-010B0P
PCB	RO4350, 20 mil, 1 oz Cu, Au Finish			

GaN Amplifier 48 V, 10 W

3.4 - 4.0 GHz



MAGB-103440-010B0P

Rev. V2

Typical Performance Curves as Measured in the 3.4 - 3.8 GHz Evaluation Test Fixture:
Pulsed⁴ 3.6 GHz, $V_{DS} = 48\text{ V}$, $I_{DQ} = 25\text{ mA}$, $T_C = 25^\circ\text{C}$ (Unless Otherwise Noted)

Gain vs. Output Power and Frequency

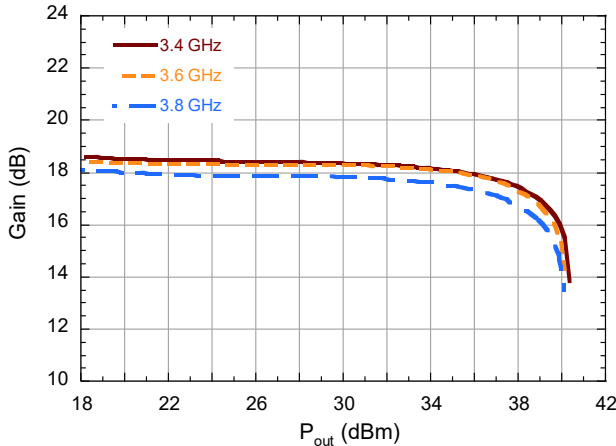

Drain Efficiency vs. Output Power and Frequency

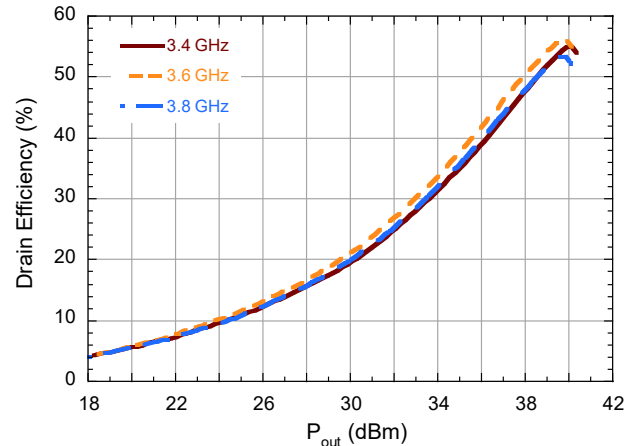

Gain vs. Output Power and T_C

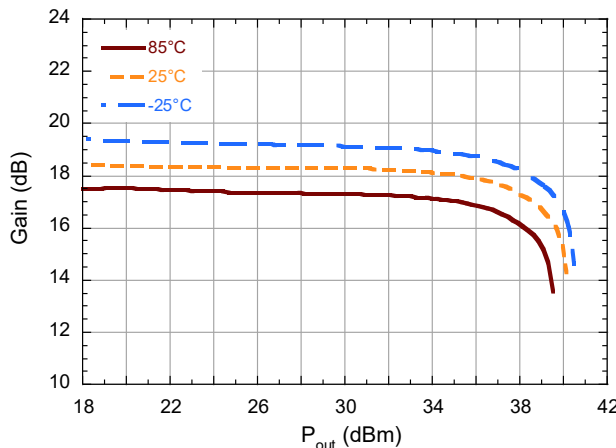

Drain Efficiency vs. Output Power and T_C

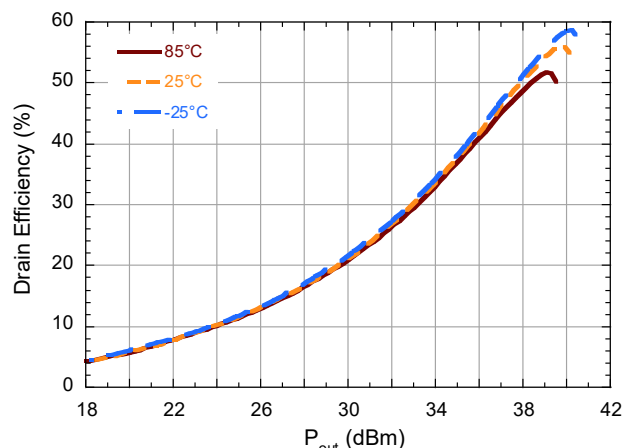

Gain vs. Frequency, 2.5dB Gain Compression

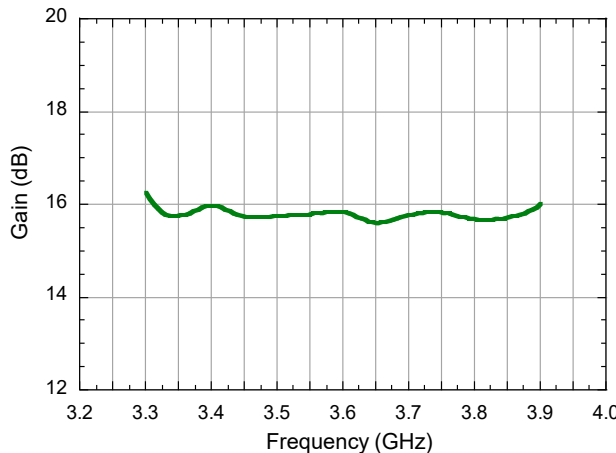

Drain Efficiency vs. Frequency, 2.5dB Gain Compression

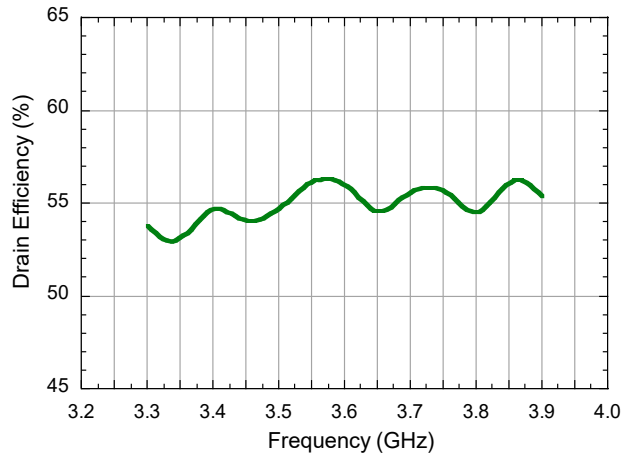

Typical Performance as Measured in the 3.4 - 3.8 GHz Evaluation Board:
WCMDA 3GPP TM1 64 DPCH 9.9 dB PAR @ 0.01% CCDF, $V_{DS} = 48\text{ V}$, $I_{DQ} = 25\text{ mA}$, $T_C = 25^\circ\text{C}$

Gain vs. Output Power and Frequency

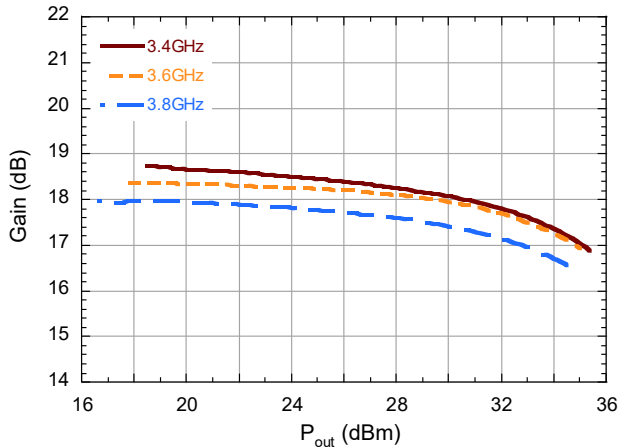

Drain Efficiency vs. Output Power and Frequency

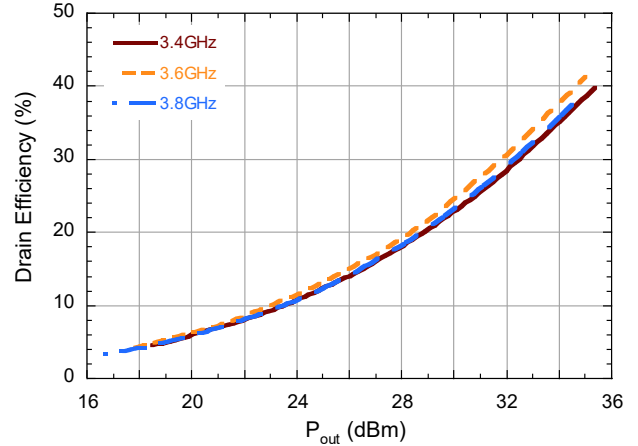

ACPR (Max $\pm 5\text{ MHz}$) vs. Output Power and Frequency

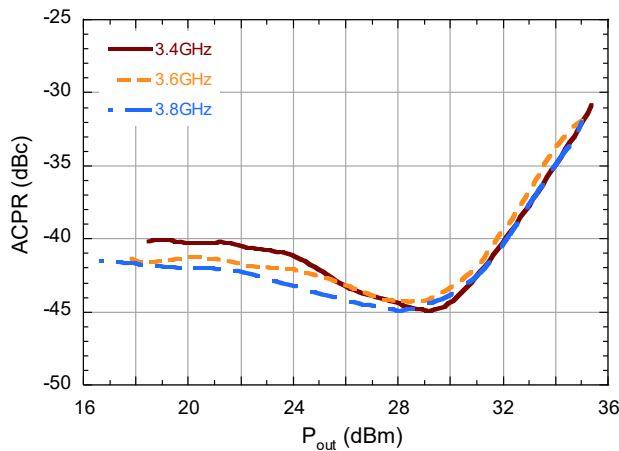

PAR (CCDF @ 0.01%) vs. Output Power and Frequency

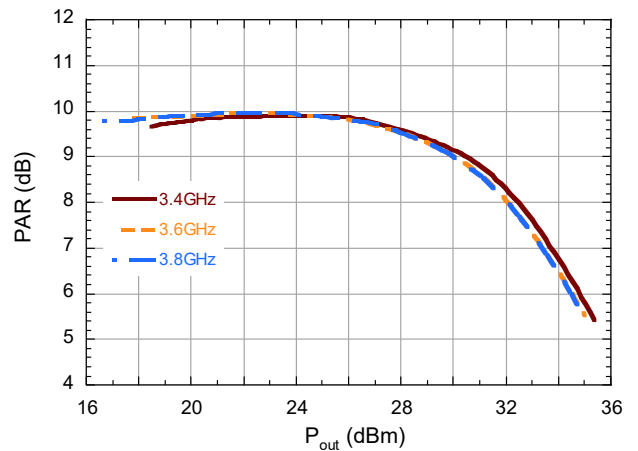

Input Return Loss vs. Output Power and Frequency

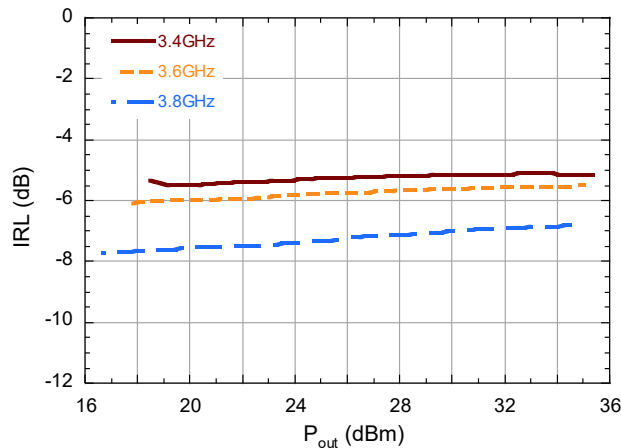

GaN Amplifier 48 V, 10 W

3.4 - 4.0 GHz



MAGB-103440-010B0P

Rev. V2

Typical Performance as Measured in the 3.4 - 3.8 GHz Evaluation Board:
WCMDA 3GPP TM1 64 DPCH 9.9 dB PAR @ 0.01% CCDF, $V_{DS} = 48$ V, $I_{DQ} = 25$ mA, $T_C = 25^\circ\text{C}$

Gain vs. Frequency at $P_{OUT} = 28$ dBm

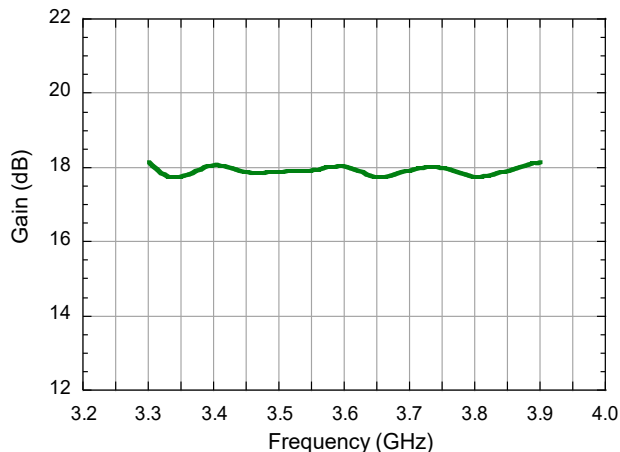

Drain Efficiency vs. Frequency at $P_{OUT} = 28$ dBm

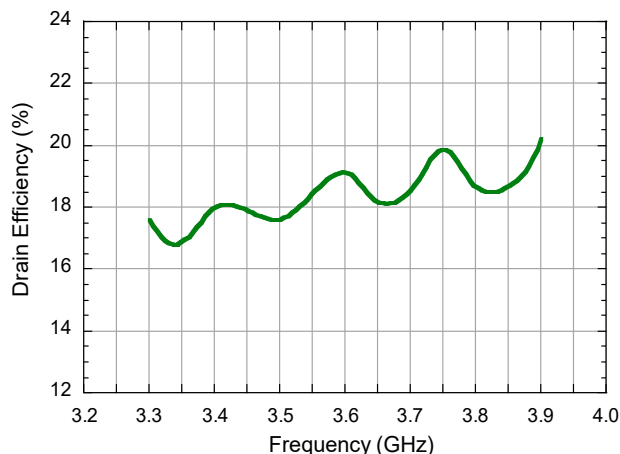

ACPR (max ± 5 MHz) vs. Frequency at $P_{OUT} = 28$ dBm

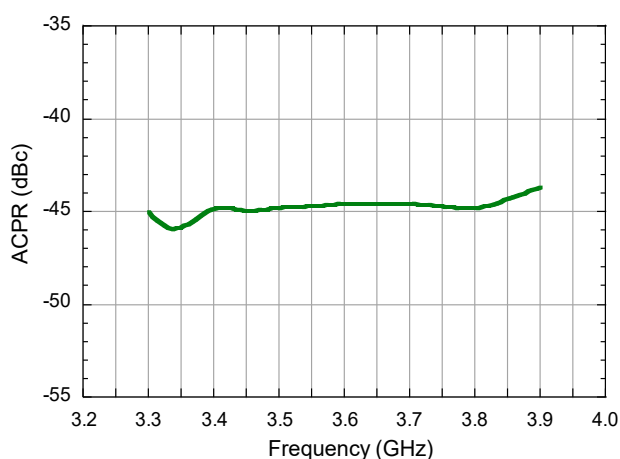

PAR (CCDF @ 0.01%) vs. Frequency at $P_{OUT} = 28$ dBm

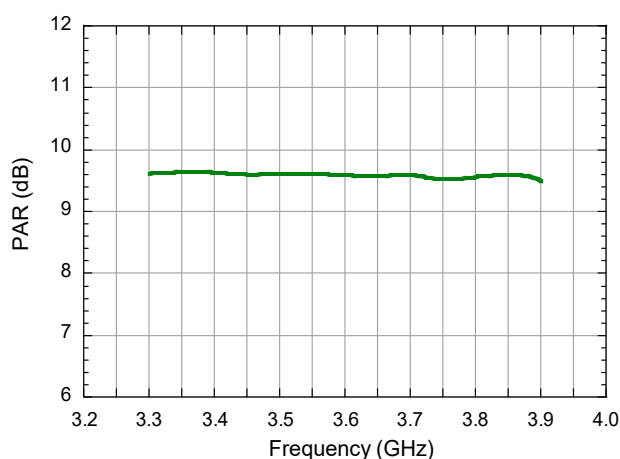

Input Return Loss vs. Frequency at $P_{OUT} = 28$ dBm

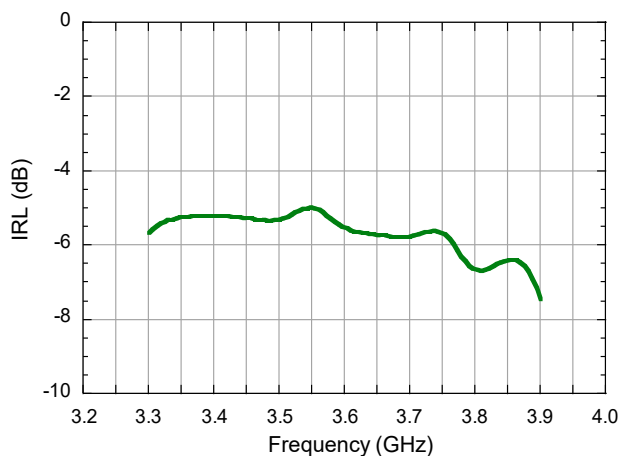

GaN Amplifier 48 V, 10 W

3.4 - 4.0 GHz



MAGB-103440-010B0P

Rev. V2

Lead-Free 4 x 4 mm 6-Lead Package Dimensions[†]

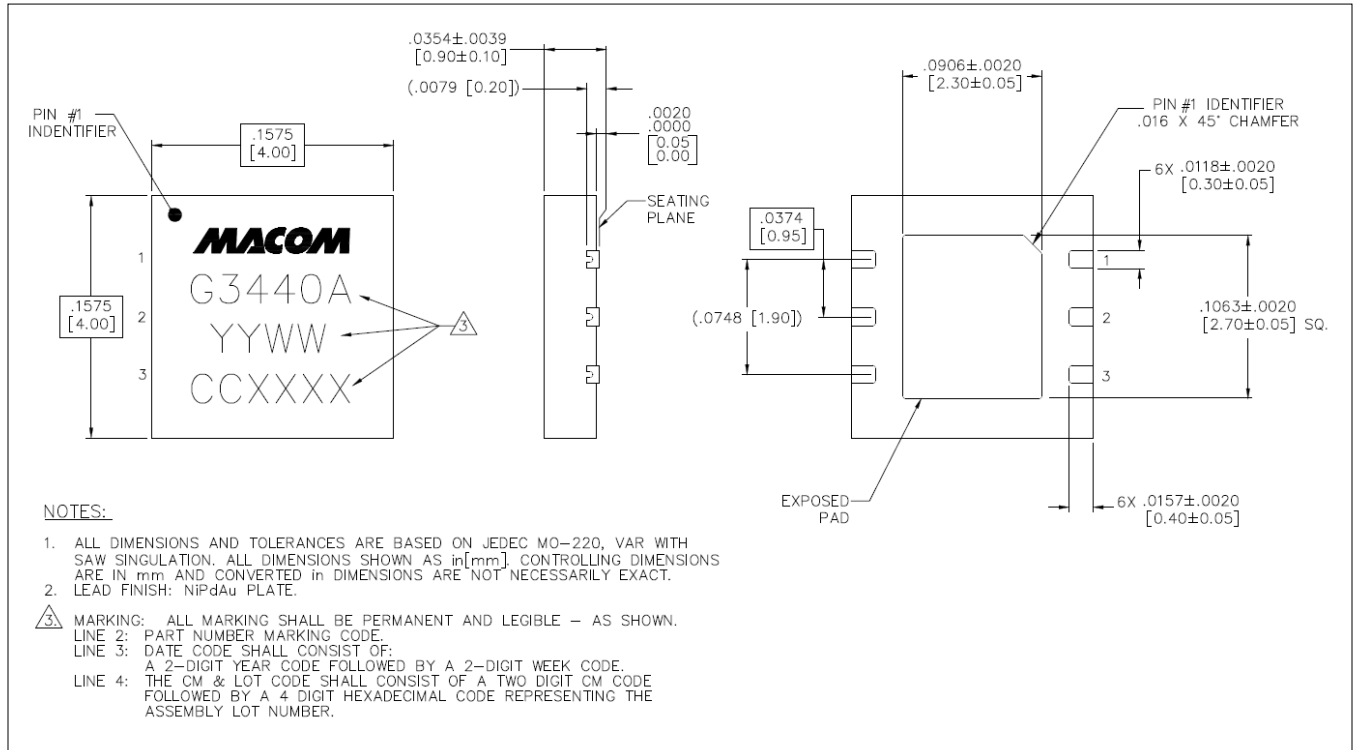

[†] Reference Application Note S2083 for lead-free solder reflow recommendations.
 Meets JEDEC moisture sensitivity level (MSL) 3 requirements.

MACOM Technology Solutions Inc. ("MACOM"). All rights reserved.

These materials are provided in connection with MACOM's products as a service to its customers and may be used for informational purposes only. Except as provided in its Terms and Conditions of Sale or any separate agreement, MACOM assumes no liability or responsibility whatsoever, including for (i) errors or omissions in these materials; (ii) failure to update these materials; or (iii) conflicts or incompatibilities arising from future changes to specifications and product descriptions, which MACOM may make at any time, without notice. These materials grant no license, express or implied, to any intellectual property rights.

THESE MATERIALS ARE PROVIDED "AS IS" WITH NO WARRANTY OR LIABILITY, EXPRESS OR IMPLIED, RELATING TO SALE AND/OR USE OF MACOM PRODUCTS INCLUDING FITNESS FOR A PARTICULAR PURPOSE, MERCHANTABILITY, INFRINGEMENT OF INTELLECTUAL PROPERTY RIGHT, ACCURACY OR COMPLETENESS, OR SPECIAL, INDIRECT, INCIDENTAL, OR CONSEQUENTIAL DAMAGES WHICH MAY RESULT FROM USE OF THESE MATERIALS.

MACOM products are not intended for use in medical, lifesaving or life sustaining applications. MACOM customers using or selling MACOM products for use in such applications do so at their own risk and agree to fully indemnify MACOM for any damages resulting from such improper use or sale.