

Features

- Plug in Design
- Low Insertion Loss
- Excellent Cross over Isolation
- Excellent Return loss
- RoHS compliant
- Lead Free

Description

MAFL-011050 is a high performance horizontal plug-in diplex filter designed specifically for the CATV infrastructure market.

Functional Schematic

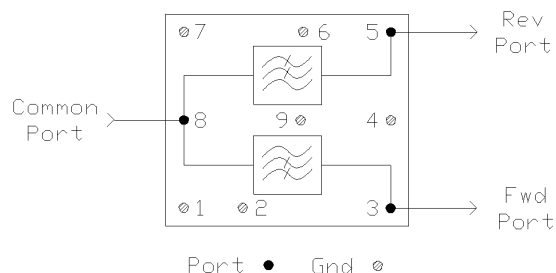

Ordering Information

Part Number	Package
MAFL-011050	200pcs per Box

Pin Configuration

Pin No.	Function
1,2,4,6,7,9	Ground
3	Forward Path Port
5	Reverse Path Port
8	Common Port

Horizontal Plug-in Diplex Filter 5 - 65 / 86 - 1218 MHz

Rev. V1

Target Electrical Specifications: $T_A = 25\text{ }^\circ\text{C}$, $Z_0 = 75\ \Omega$

Parameter	Units	Min	Typ	Max
Insertion loss				
Reverse Path				
5 - 65 MHz	dB	—	1.0	1.2
Forward Path				
86 - 1218 MHz	dB	—	1.0	1.2
Isolation				
5 - 65 MHz	dB	48	51	—
65 - 86 MHz	dB	38	41	—
86 - 1002 MHz	dB	45	51	—
1002 - 1218 MHz	dB	40	45	—
Return Loss				
Common Port				
5 - 65 MHz	dB	22	24	—
86 - 750 MHz	dB	22	24	—
750 - 1218 MHz	dB	19	21	—
Group Delay				
Reverse Path				
62 - 63.5 MHz	nSec	—	10	—
63.5 - 65 MHz	nSec	—	17	—
Forward Path				
112.25 - 116.68 MHz	nSec	—	17	—
120.25 - 124.68 MHz	nSec	—	10	—

Recommended Maximum Ratings^{1,2}

Parameter	Absolute maximum
RF power	250mW
DC current	30mA
Operating temperature	-40°C to +85°C
Storage temperature	-40°C to +85°C

1. Exceeding any one or combination of these limits may cause permanent damage to this device.
2. MACOM does not recommend sustained operation near these survivability limits.

MAFL-011050



Horizontal Plug-in Diplex Filter
5 - 65 / 86 - 1218 MHz

Rev. V1

Outline Drawing

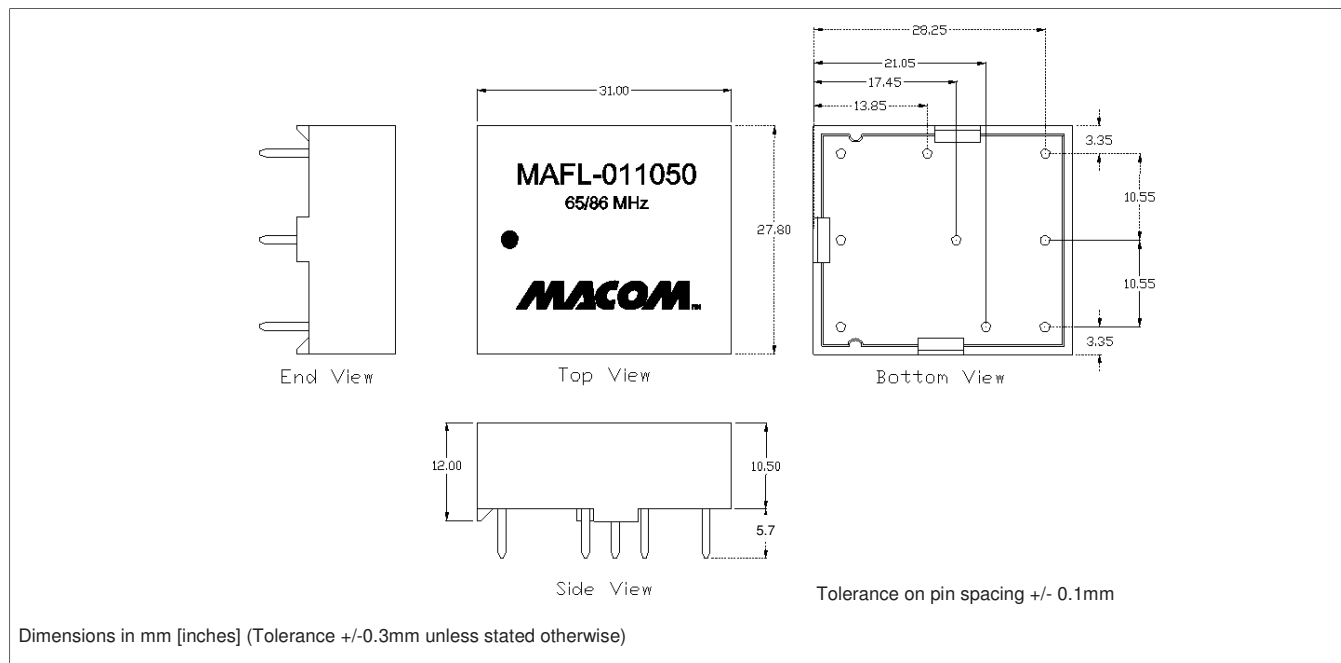

Typical Performance Curves:

Low Pass Filter

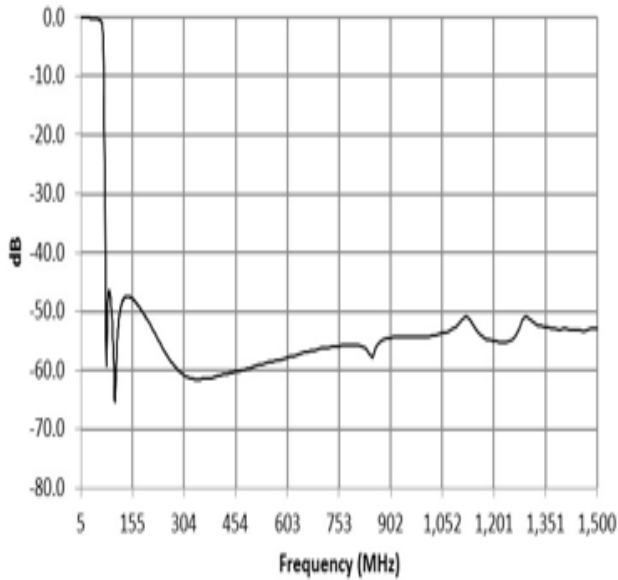

High Pass Filter

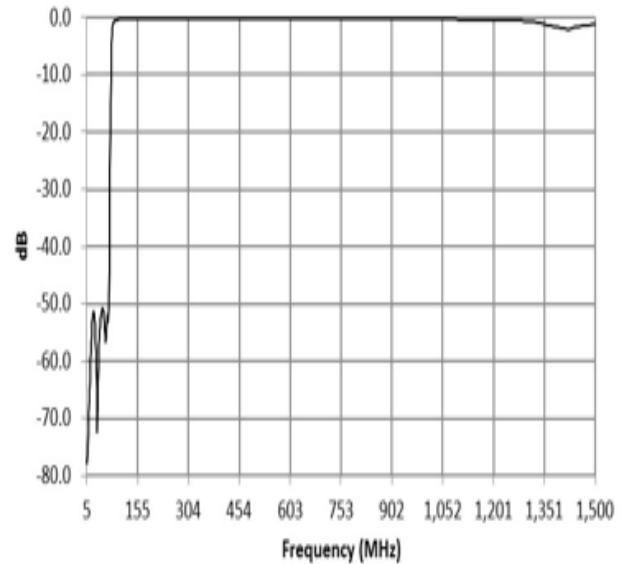

Common Port Return Loss

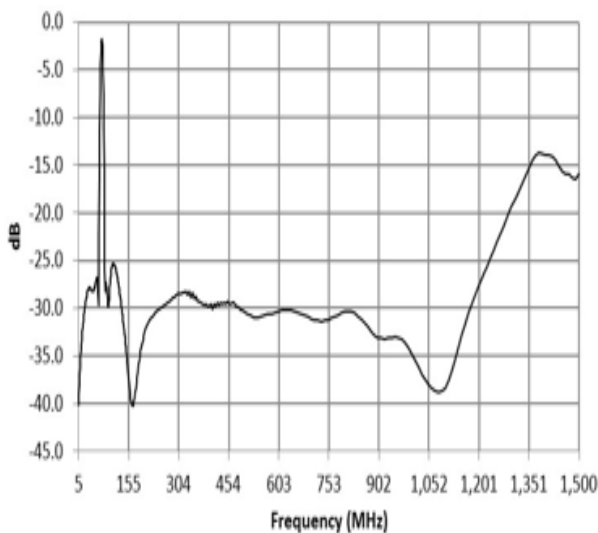

Isolation

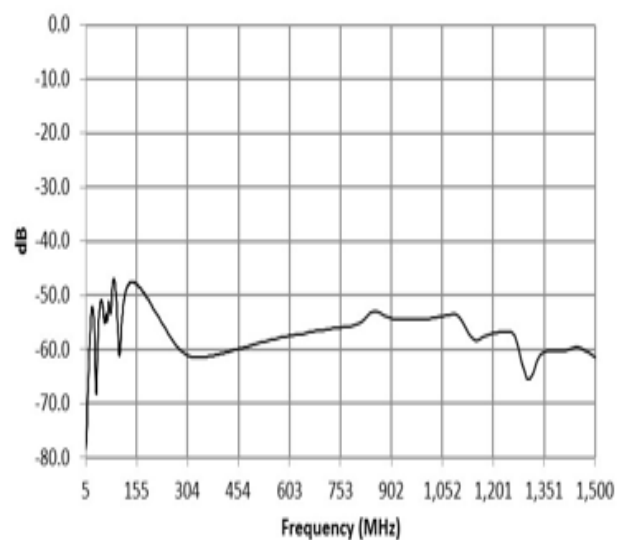

M/A-COM Technology Solutions Inc. All rights reserved.

Information in this document is provided in connection with M/A-COM Technology Solutions Inc ("MACOM") products. These materials are provided by MACOM as a service to its customers and may be used for informational purposes only. Except as provided in MACOM's Terms and Conditions of Sale for such products or in any separate agreement related to this document, MACOM assumes no liability whatsoever. MACOM assumes no responsibility for errors or omissions in these materials. MACOM may make changes to specifications and product descriptions at any time, without notice. MACOM makes no commitment to update the information and shall have no responsibility whatsoever for conflicts or incompatibilities arising from future changes to its specifications and product descriptions. No license, express or implied, by estoppel or otherwise, to any intellectual property rights is granted by this document.

THESE MATERIALS ARE PROVIDED "AS IS" WITHOUT WARRANTY OF ANY KIND, EITHER EXPRESS OR IMPLIED, RELATING TO SALE AND/OR USE OF MACOM PRODUCTS INCLUDING LIABILITY OR WARRANTIES RELATING TO FITNESS FOR A PARTICULAR PURPOSE, CONSEQUENTIAL OR INCIDENTAL DAMAGES, MERCHANTABILITY, OR INFRINGEMENT OF ANY PATENT, COPYRIGHT OR OTHER INTELLECTUAL PROPERTY RIGHT. MACOM FURTHER DOES NOT WARRANT THE ACCURACY OR COMPLETENESS OF THE INFORMATION, TEXT, GRAPHICS OR OTHER ITEMS CONTAINED WITHIN THESE MATERIALS. MACOM SHALL NOT BE LIABLE FOR ANY SPECIAL, INDIRECT, INCIDENTAL, OR CONSEQUENTIAL DAMAGES, INCLUDING WITHOUT LIMITATION, LOST REVENUES OR LOST PROFITS, WHICH MAY RESULT FROM THE USE OF THESE MATERIALS.

MACOM products are not intended for use in medical, lifesaving or life sustaining applications. MACOM customers using or selling MACOM products for use in such applications do so at their own risk and agree to fully indemnify MACOM for any damages resulting from such improper use or sale.