

Features

- Low Series Resistance
- Low Capacitance
- High Cutoff Frequency
- Silicon Nitride Passivation
- Polyimide Scratch Protection
- Designed for Easy Circuit Insertion

Applications

- Radar
- Communications
- Test and Measurement

Description

The MADZ-011002 Single junction, MADZ-011003 anti-parallel pair, MADZ-011004 reverse tee and MADZ-011005 unconnected anti-parallel pair are gallium arsenide flip chip THz Schottky barrier diodes.

These devices are fabricated on OMCVD epitaxial wafers using a process designed for high device uniformity and extremely low parasitics. The diodes are fully passivated with silicon nitride and have an additional layer of polyimide for scratch protection. The protective coatings prevent damage to the junction during automated or manual handling. The flip chip configuration is suitable for pick and place insertion.

The high cutoff frequencies of these diodes allow use through G and W band frequencies. Typical applications include single and double balanced mixers in radio transceivers and automotive radars.

The MADZ-011003 anti-parallel pair is designed for use in sub harmonically pumped mixers. Close matching of the diode characteristics results in high LO suppression at the RF input.

The MADZ-011005 unconnected pair may be used in temperature-compensated detector circuits, as well as receiver protector limiter circuits and more.

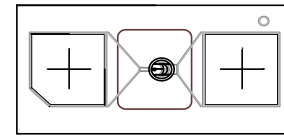

MADZ-011002

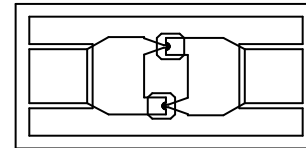

MADZ-011003

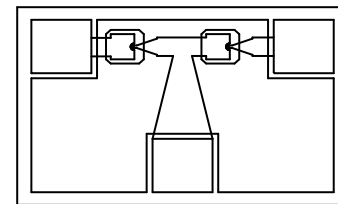

MADZ-011004

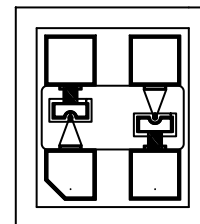

MADZ-011005

Ordering Information

Part Number	Package
MADZ-011002-1278G0	25 piece gel pack
MADZ-011003-1197G0	
MADZ-011004-1199G0	
MADZ-011005-1262G0	

Electrical Specifications @ +25 °C

Parameters and Test Conditions	Symbol	Units	MADZ-011002			MADZ-011003		
			Min.	Typ.	Max.	Min.	Typ.	Max.
Junction Capacitance @ 0 V, 1 MHz ^{1,3}	C _J	fF	-	40	-	-	40	-
Total Capacitance @ 0 V, 1 MHz ^{1,3}	C _T	fF	.	49	-	.	49	-
Slope Resistance @ +10 mA ²	R _S	Ω	-	4	7	-	4	7
Forward Voltage @+1 mA	V _{F1}	V	0.60	0.70	0.80	0.60	0.70	0.80
Forward Voltage Difference @ +1 mA	ΔV _F	mV	-	-	-	-	5	10
Reverse Breakdown Voltage @ -10 μA	V _{BR}	V	4.5	7	-	-	-	-
SSB Noise Figure	NF	dB	-	6.5	-	-	6.5	-
Series Resistance	R _S	Ω	-	3.35	-	-	3.35	-
Intrinsic Cutoff Frequency		THz	-	1.0	-	-	1.0	-
Extrinsic Cutoff Frequency		GHz	-	62	-	-	62	-

Parameters and Test Conditions	Symbol	Units	MADZ-011004			MADZ-011005		
			Min.	Typ.	Max.	Min.	Typ.	Max.
Junction Capacitance at 0 V at 1 MHz ^{1,3}	C _J	fF	-	40	-	-	40	-
Total Capacitance at 0 V at 1 MHz ^{1,3}	C _T	fF	.	49	-	.	49	-
Junction Capacitance Difference	ΔC _J	fF	-	5	10	-	5	10
Slope Resistance at +10 mA ²	R _S	Ω	-	4	7	-	4	7
Forward Voltage at +1 mA	V _{F1}	V	0.60	0.70	0.80	0.60	0.70	0.80
Forward Voltage Difference at +1 mA	ΔV _F	mV	-	5	10	5	-	10
Reverse Breakdown Voltage at -10 μA	V _{BR}	V	4.5	7	-	-	4.5	7
SSB Noise Figure	NF	dB	-	6.5	-	-	-	6.5
Series Resistance	R _S	Ω	-	3.35	-	-	3.35	-
Intrinsic Cutoff Frequency		THz	-	1.0	-	-	1.0	-
Extrinsic Cutoff Frequency		GHz	-	62	-	-	62	-

1. Total capacitance is equivalent to the sum of junction capacitance and parasitic capacitance.
2. Slope resistance is determined by measuring the dynamic resistance and subtracting the junction resistance of 2.6 Ω.
3. Capacitance for the MADZ-011003, MADZ-011004 and MADZ-011005 is specified for each Schottky diode junction.

Absolute Maximum Ratings^{5,6}

Parameter	Absolute Maximum
LO & RF Incident Power	20 dBm
Mounting Temperature	+235°C for 10 seconds
Operating Temperature	-65°C to +125°C
Storage Temperature	-65°C to +150°C

- Exceeding any one or combination of these limits may cause permanent damage to this device.
- MACOM does not recommend sustained operation near these survivability limits.

Handling Procedures

Please observe the following precautions to avoid damage:

Static Sensitivity

These electronic devices are sensitive to electrostatic discharge (ESD) and can be damaged by static electricity. Proper ESD control techniques should be used when handling these Human Body Model (HBM) Class 0 devices.

Cleanliness:

The chips should be handled in a clean environment. Do not attempt to clean die after installation.

Static Sensitivity:

Schottky barrier diodes are ESD sensitive and can be damaged by static electricity. Proper ESD techniques should be used when handling these devices.

General Handling:

The protective polymer coating on the active areas of these die provides scratch protection, particularly for the metal air bridge which contacts the anode. Die can be handled with tweezers or vacuum pickups and are suitable for use with auto-

Forward Current vs. Temperature

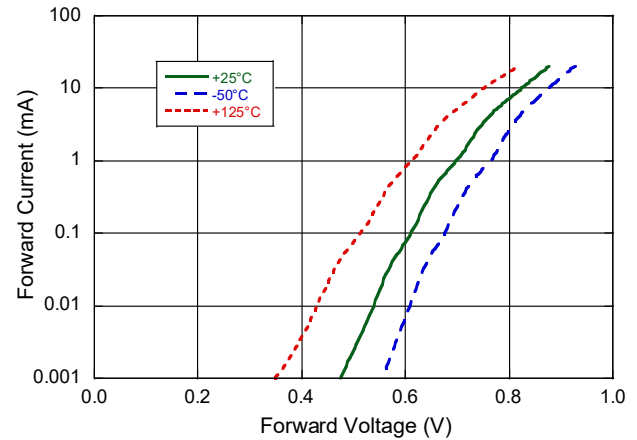

Mounting Techniques

This device is designed to be inserted onto hard or soft substrates with the junction side down. It can be mounted with conductive epoxy or with a low temperature solder preform.

Solder Die Attach:

Solder which does not scavenge gold, such as Indalloy #2, is recommended. Sn-Pb based solders are not recommended due to solder embrittlement. Do not expose die to a temperature >235°C, or >200°C for longer than 10 seconds. No more than 3 seconds of scrubbing should be required for attachment.

Epoxy Die Attach:

Assembly can be preheated to 125 - 150°C. Use a minimum amount of epoxy. Cure epoxy as per manufacturer's schedule. For extended cure times, temperatures should be kept below 200°C.

Typical Performance @ +25 °C, $Z_0 = 50 \Omega$

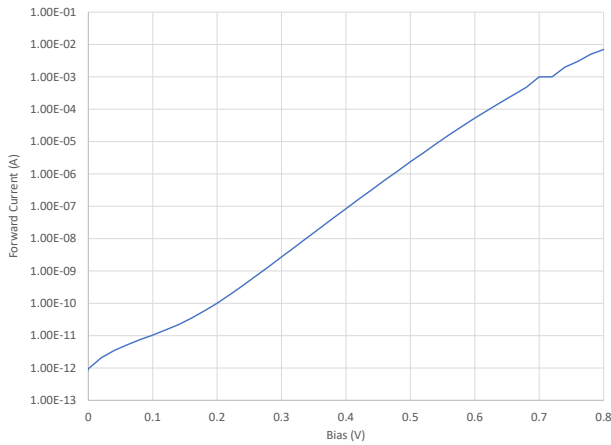

Forward Current vs. Forward Bias Voltage,
MADZ-011002

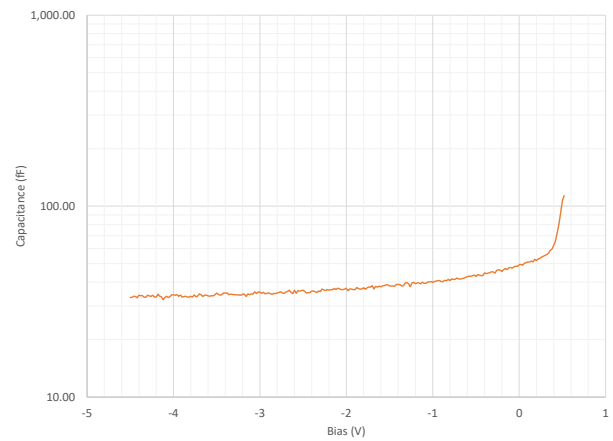

Capacitance vs. Reverse Bias Voltage,
MADZ-011002

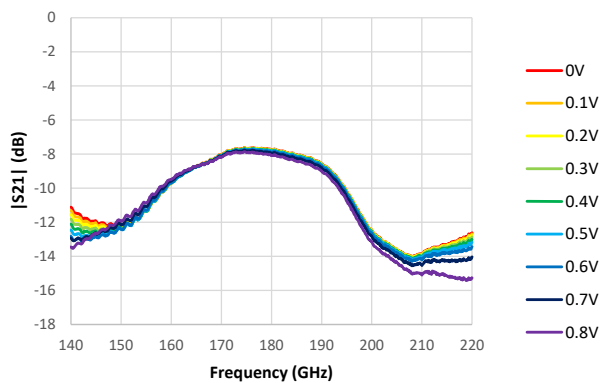

$|s_{21}|$ vs. Forward Bias Voltage, Series Connection, G Band, MADZ-011002

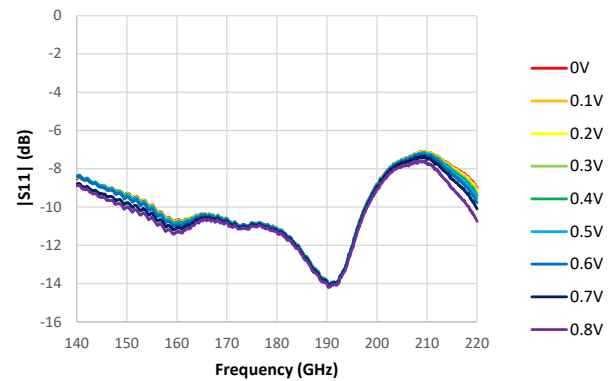

$|s_{11}|$ vs. Forward Bias Voltage, Series Connection, G Band, MADZ-011002

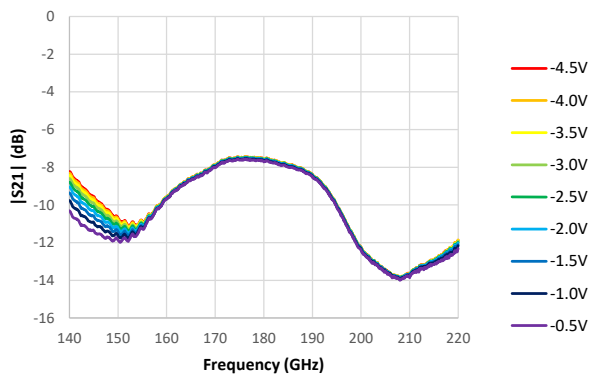

$|s_{21}|$ vs. Reverse Bias Voltage, Series Connection, G Band, MADZ-011002

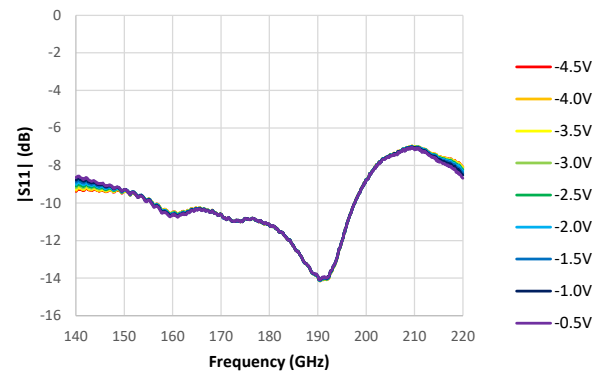

$|s_{11}|$ vs. Reverse Bias Voltage, Series Connection, G Band, MADZ-011002

Typical Performance @ +25 °C, $Z_0 = 50 \Omega$

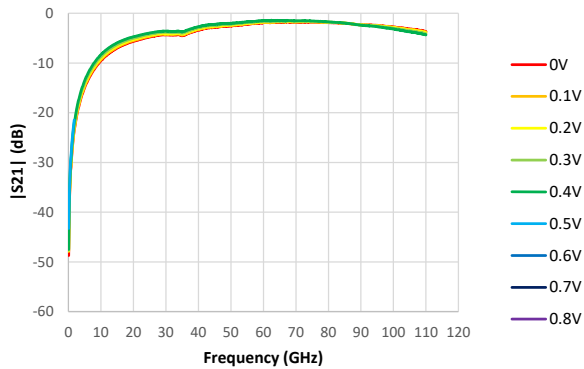

$|s_{21}|$ vs. Forward Bias Voltage, Series Connection, W Band, MADZ-011002

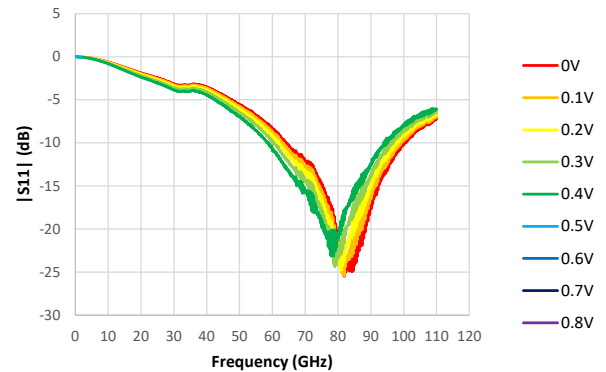

$|s_{11}|$ vs. Forward Bias Voltage, Series Connection, W Band, MADZ-011002

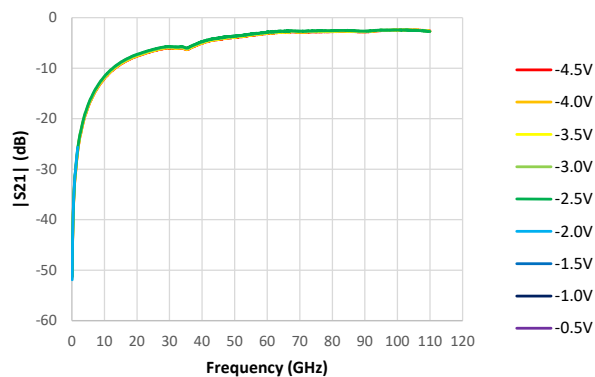

$|s_{21}|$ vs. Reverse Bias Voltage, Series Connection, W Band, MADZ-011002

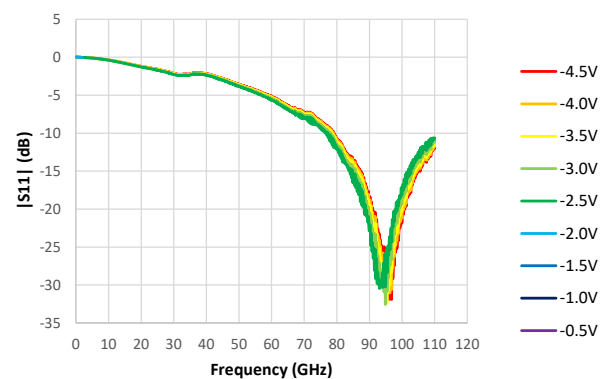

$|s_{11}|$ vs. Reverse Bias Voltage, Series Connection, W Band, MADZ-011002

SPICE Parameters (per junction)

Parameter	Area	Periphery	I_s	N	R_s	J_{sw}	N_s
Value	1	1	7.774e-12	1.09	5.05	98.9e-15	1.16

Parameter	R_{sw}	Gleak	Bv	I_{bv}	Nbv	I_{bv1}	Nbv1
Value	250	1.12e-18	2	1.05e-11	20	4.51e-11	51.7

Outline Drawings

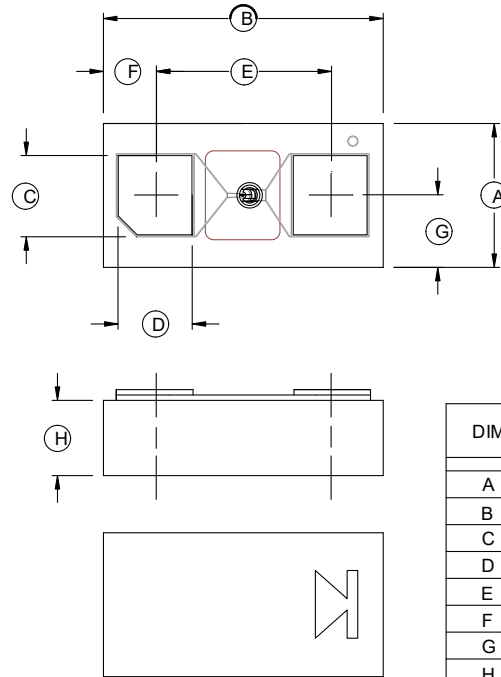

DIM.	INCHES		MILLIMETERS	
	MIN.	MAX.	MIN.	MAX.
A	0.013	0.014	0.330	0.335
B	0.026	0.027	0.660	0.685
C	0.008	0.009	0.203	0.228
D	0.007	0.008	0.177	0.203
E	0.016	0.017	0.406	0.430
F	0.004	0.006	0.101	0.152
G	0.006	0.007	0.152	0.177
H	0.0075	0.0085	0.190	0.216

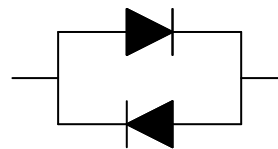
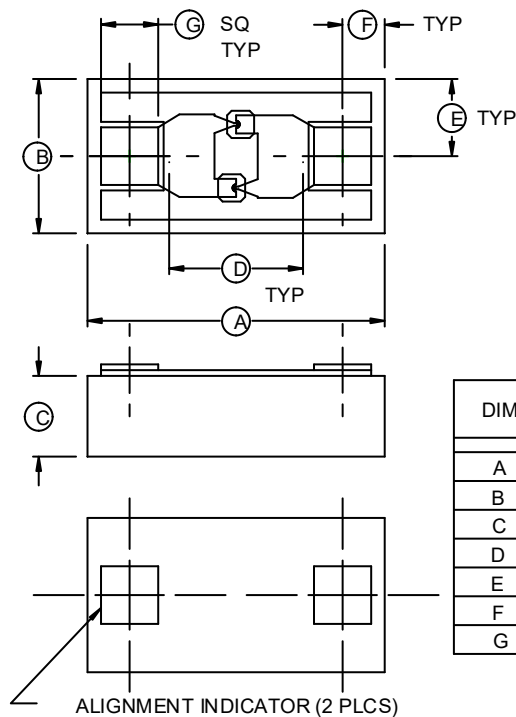

DIM.	INCHES		MILLIMETERS	
	MIN.	MAX.	MIN.	MAX.
A	.025	.027	.64	.69
B	.012	.015	.32	.37
C	.006	.008	.15	.20
D	.018	.020	.45	.50
E	.0075	.0085	.190	.216
F	.003	.005	.08	.13
G	.004	.006	.10	.15

Outline Drawings

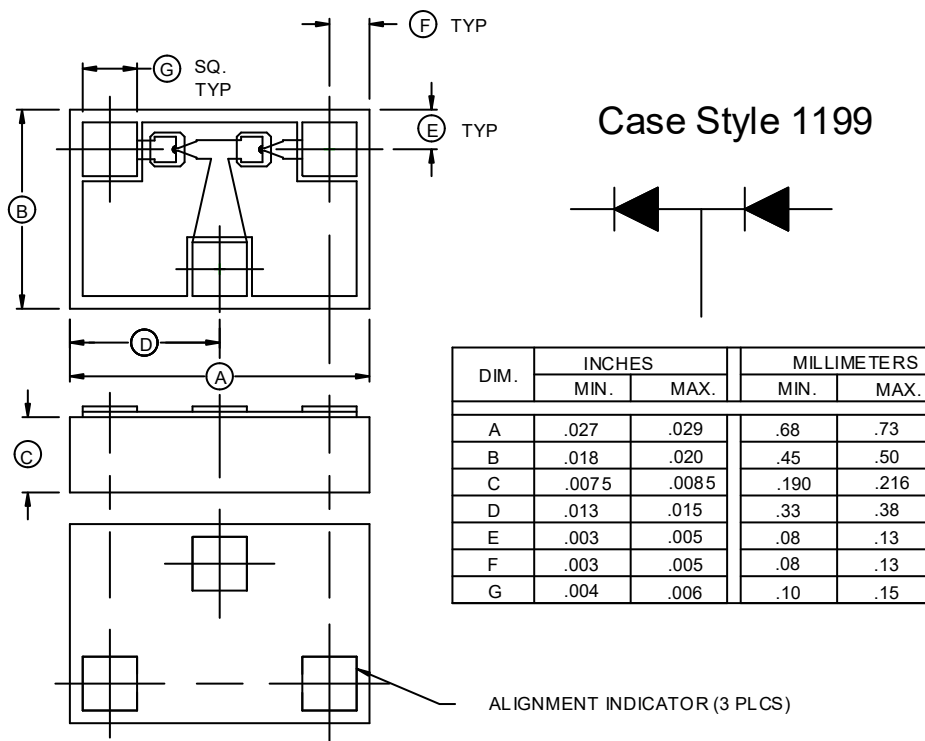

Outline Drawings

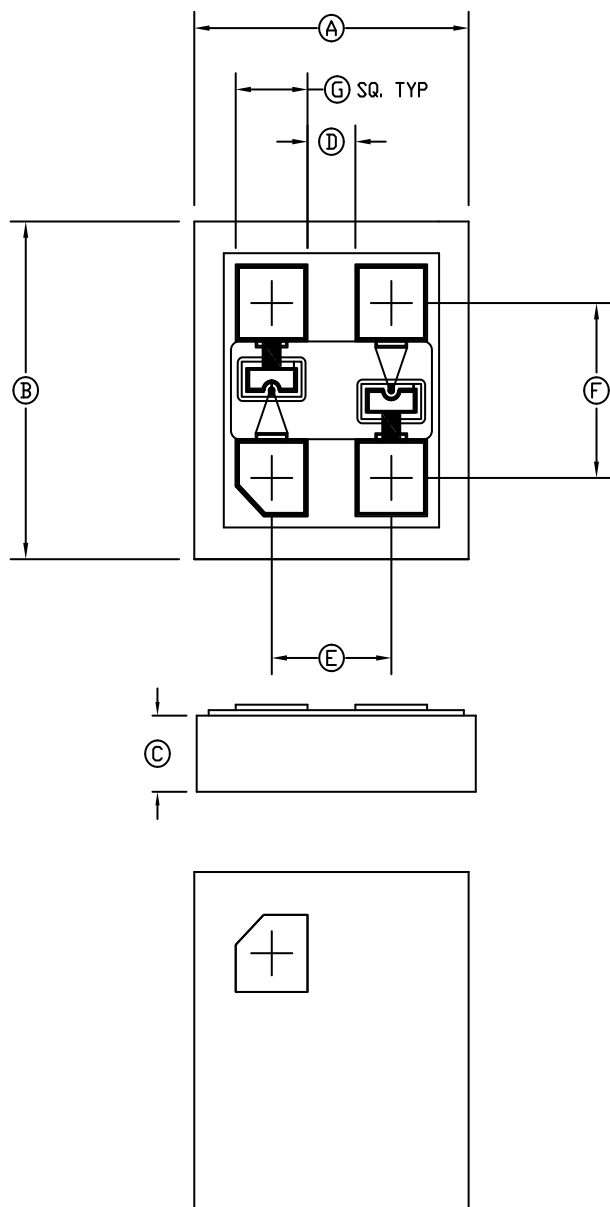

Case Style 1262

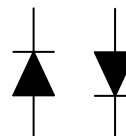

DIM.	INCHES		MILLIMETERS	
	MIN.	MAX.	MIN.	MAX.
A	.012	.013	.30	.33
B	.014	.015	.350	.38
C	.006	.008	.152	.203
D	.002	.003	.048	.073
E	.005	.006	.138	.163
F	.008	.009	.192	.217
G	.0035 TYPICAL		.090 TYPICAL	

MACOM Technology Solutions Inc. ("MACOM"). All rights reserved.

These materials are provided in connection with MACOM's products as a service to its customers and may be used for informational purposes only. Except as provided in its Terms and Conditions of Sale or any separate agreement, MACOM assumes no liability or responsibility whatsoever, including for (i) errors or omissions in these materials; (ii) failure to update these materials; or (iii) conflicts or incompatibilities arising from future changes to specifications and product descriptions, which MACOM may make at any time, without notice. These materials grant no license, express or implied, to any intellectual property rights.

THESE MATERIALS ARE PROVIDED "AS IS" WITH NO WARRANTY OR LIABILITY, EXPRESS OR IMPLIED, RELATING TO SALE AND/OR USE OF MACOM PRODUCTS INCLUDING FITNESS FOR A PARTICULAR PURPOSE, MERCHANTABILITY, INFRINGEMENT OF INTELLECTUAL PROPERTY RIGHT, ACCURACY OR COMPLETENESS, OR SPECIAL, INDIRECT, INCIDENTAL, OR CONSEQUENTIAL DAMAGES WHICH MAY RESULT FROM USE OF THESE MATERIALS.

MACOM products are not intended for use in medical, lifesaving or life sustaining applications. MACOM customers using or selling MACOM products for use in such applications do so at their own risk and agree to fully indemnify MACOM for any damages resulting from such improper use or sale.