

90° Hybrid Coupler 2 - 5 GHz



MACP-011097
Rev. V2

Features

- Broadband: 2 - 5 GHz
- Low Insertion Loss: 1 dB
- Excellent Phase Balance: 5°
- Miniature Lead-Free Surface Mount Package
- RoHS* Compliant

Applications

- Test and Measurement

Description

The MACP-011097 is a fully integrated 2 - 5 GHz 90° hybrid coupler. Offering best in class RF performance in a miniature package.

Functional Schematic

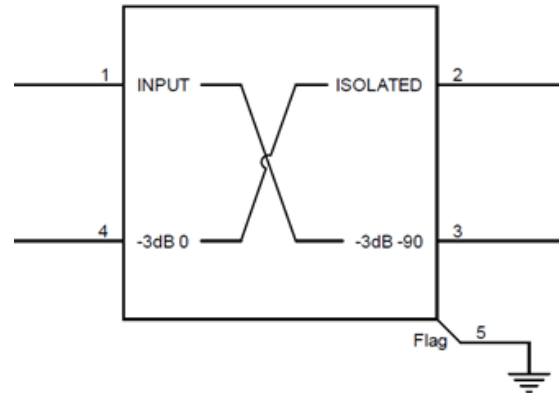

Ordering Information^{1,2}

Part Number	Package
MACP-011097	Gel Pack
MACP-011097-W00001	Wafer Frame
MACP-011097-TR0100	100 Piece Reel
MACP-011097-TR0500	500 Piece Reel
MACP-011097-SB1	Sample Board

1. Reference Application Note M513 for reel size information.
2. All sample boards include 5 loose parts.

Pin Names

Pin #	Function
1 - 4	R_{FIN} / R_{FOUT}
5	GND ³

3. The exposed die backside GND metal must be connected to RF, DC and thermal ground.

* Restrictions on Hazardous Substances, compliant to current RoHS EU directive.

90° Hybrid Coupler 2 - 5 GHz



MACP-011097
Rev. V2

Pin Description⁴

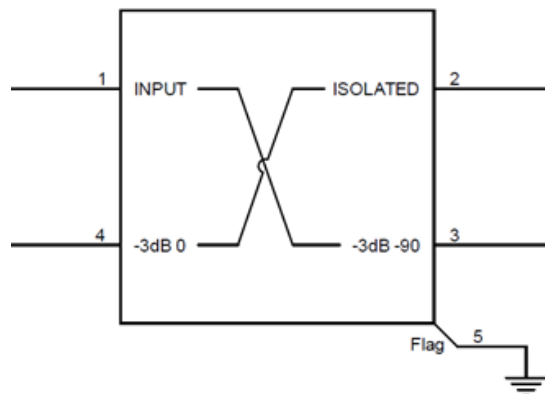

Configuration	Pin 1	Pin 2	Pin 3	Pin 4	Pin 5
Configuration 1	Input	Isolated	-3dB -90°	-3dB 0°	GND
Configuration 2	Isolated	Input	-3dB 0°	-3dB -90°	GND

4. Pin descriptions shown on diagram for Configuration 1.

AC Electrical Specifications: Freq. = 2 - 5 GHz, T_A = 25°C, Z₀ = 50 Ω

Parameter	Test Conditions	Units	Min.	Typ.	Max.
Insertion Loss	Configurations 1 & 2	dB	—	0.75	1.2
Amplitude Balance	Configurations 1 & 2	dB	—	1	—
Phase Balance from 90°	Configurations 1 & 2	°	—	3.5	6
Isolation	Configurations 1 & 2	dB	—	30	—
Return Loss	All ports & Configurations	dB	—	20	—

90° Hybrid Coupler 2 - 5 GHz



MACP-011097
Rev. V2

Recommended Operating Conditions⁵

Parameter	Unit	Min.	Typ.	Max.
RF Input Power ⁶	dBm	—	—	30
DC Current ⁶	mA	—	—	140
Operating Temperature	°C	-55	—	+105

5. All pins and frequencies
6. See derating graph below

Absolute Maximum Ratings^{7,8}

Parameter	Unit	Min	Max
RF Input Power	dBm	—	+34
DC current	mA	—	200
Storage Temperature	°C	-55	+105

7. Exceeding any one or combination of these limits may cause permanent damage to this device.
8. MACOM does not recommend sustained operation near these survivability limits.

Maximum RF vs. DC Input De-Rating Curve @
T_A = +105°C

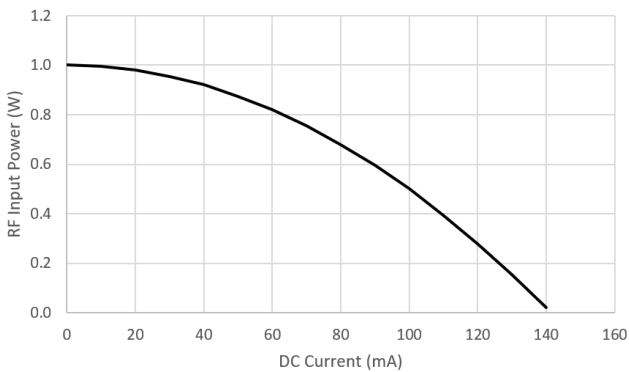

90° Hybrid Coupler 2 - 5 GHz



MACP-011097
Rev. V2

Die Back Metallization

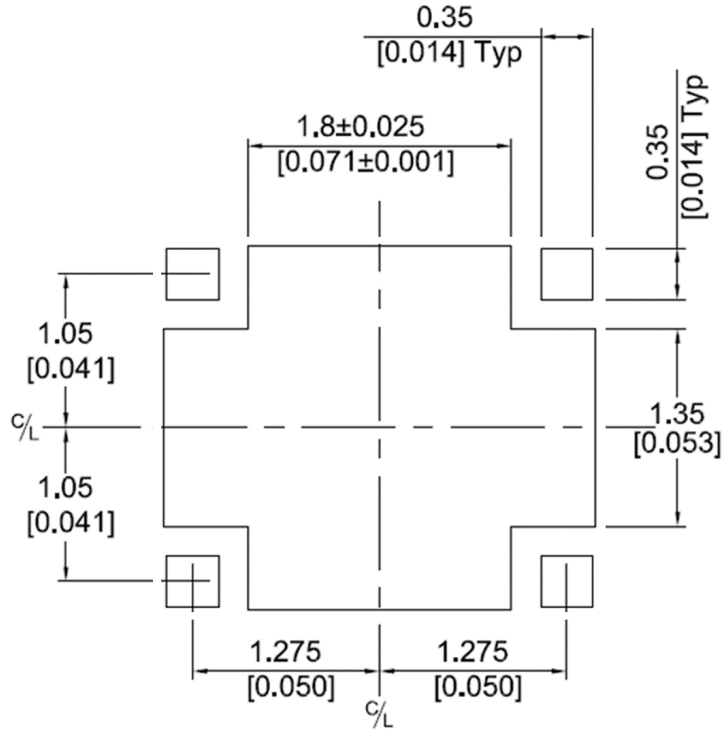

Application Schematic

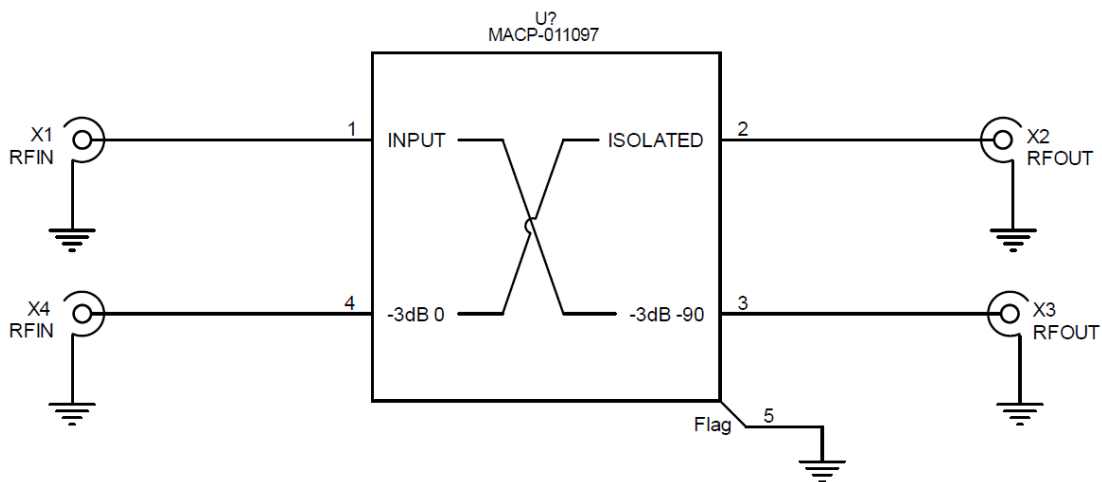

Recommended PCB footprint⁹

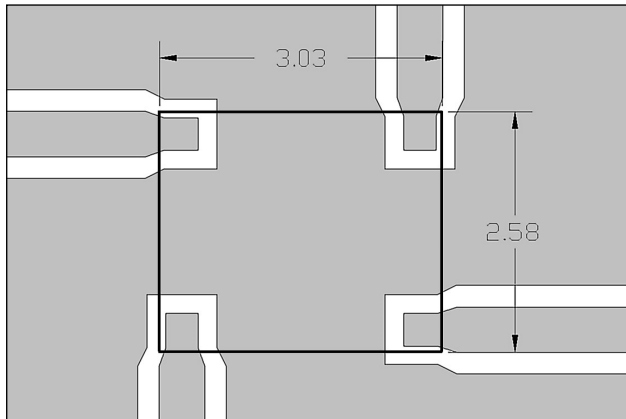

Solder mask coverage⁹

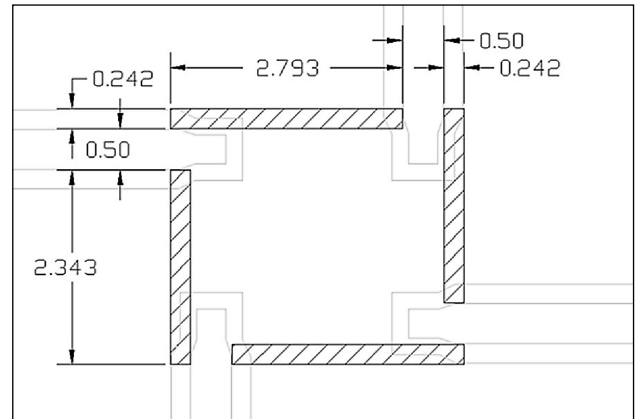

Solder paste template⁹

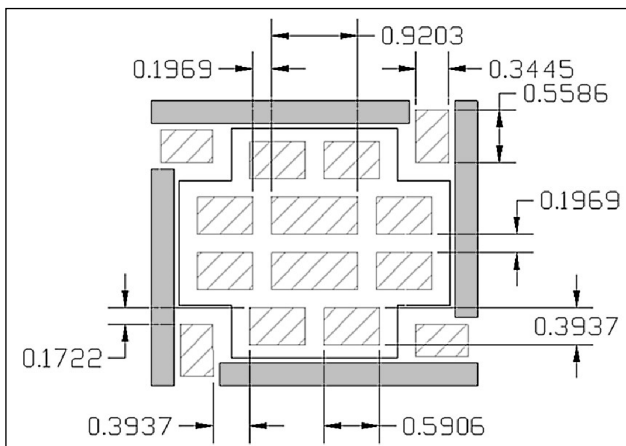

RF line dimensions⁹

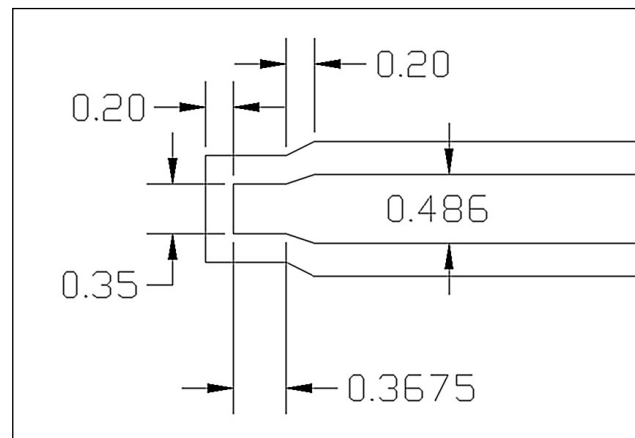

9. Dimensions in mm.

Die Exclusion Area For Pickup Tool

Keep out area for surface contact type pickup collets

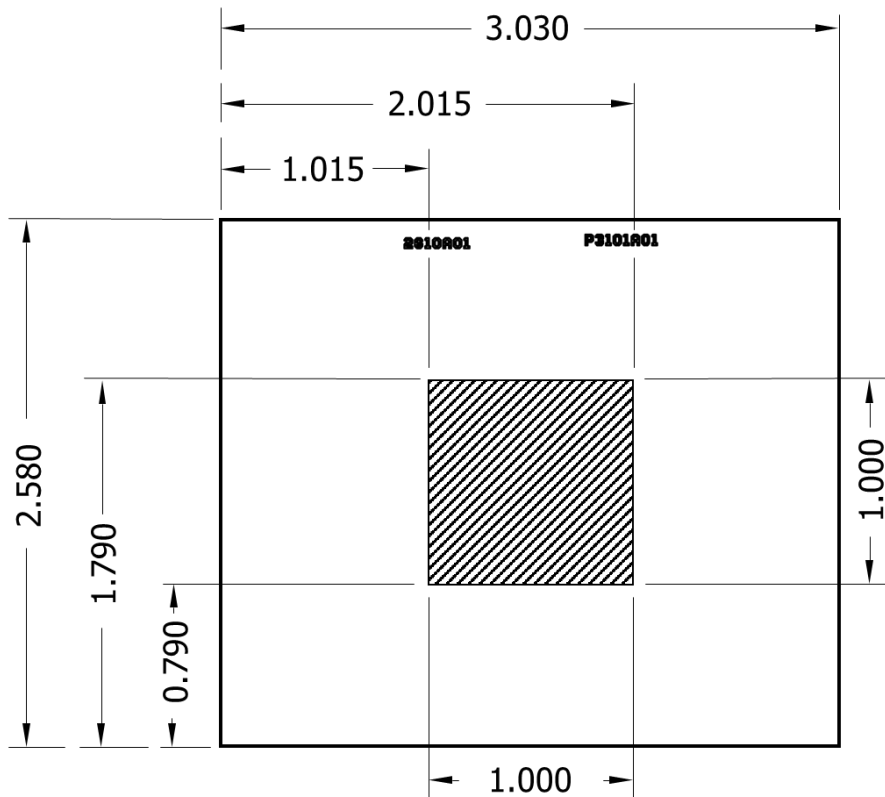

EXCLUSION AREA FOR PICKUP
Dimensions in mm

90° Hybrid Coupler 2 - 5 GHz



MACP-011097
Rev. V2

Typical Performance Curves: Configuration 1

Coupling

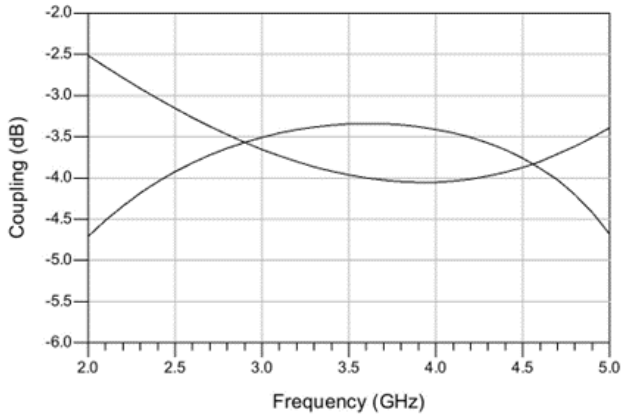

Phase Balance

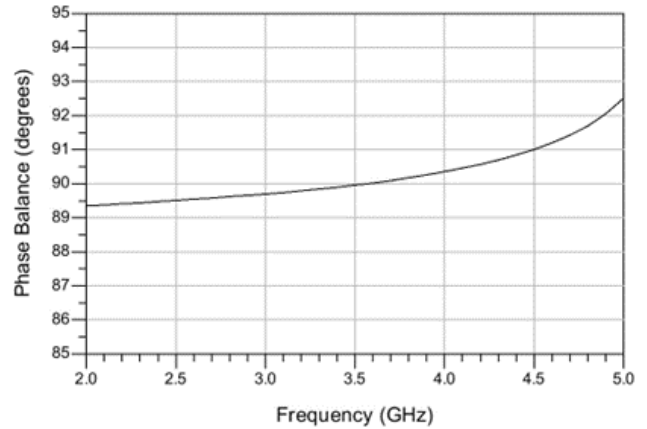

Return Losses

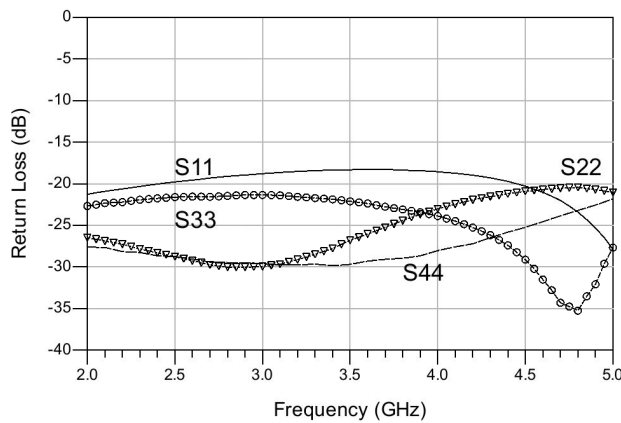

Isolation

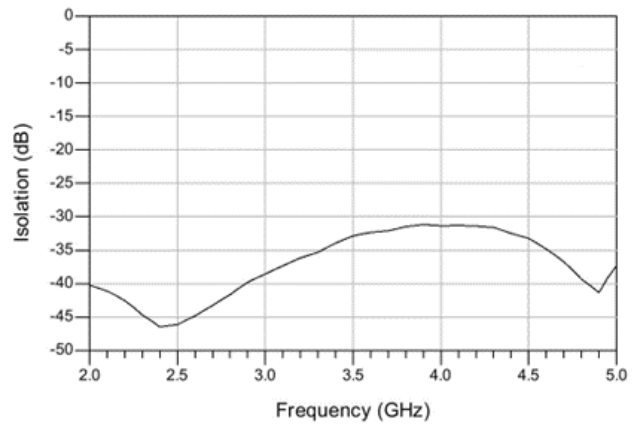

Insertion Loss

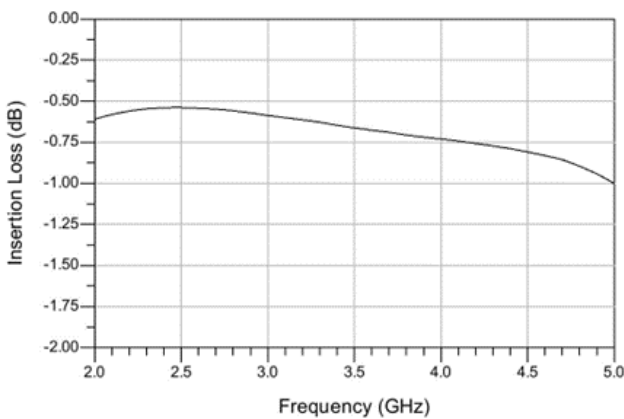

90° Hybrid Coupler 2 - 5 GHz



MACP-011097
Rev. V2

Typical Performance Curves: Configuration 2

Coupling

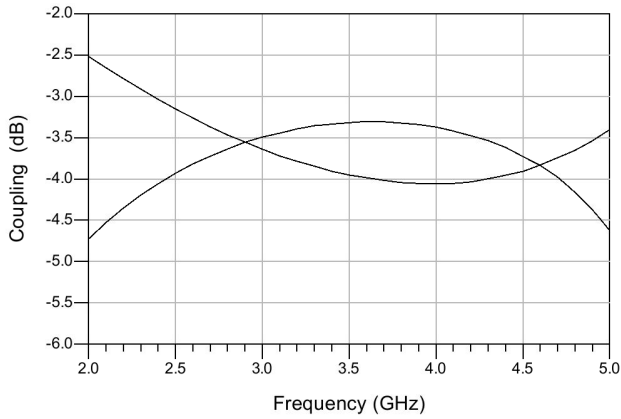

Phase Balance

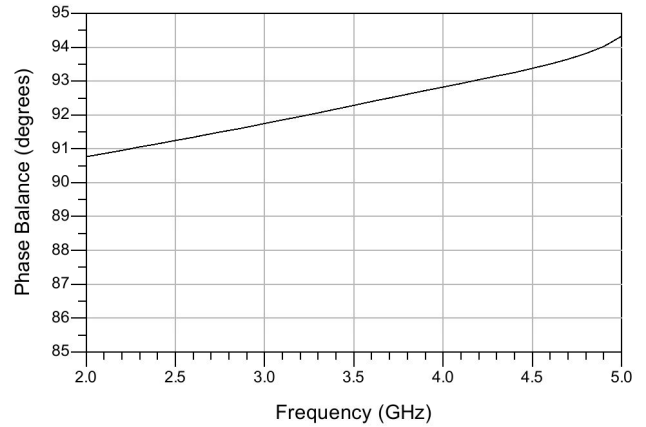

Return Losses

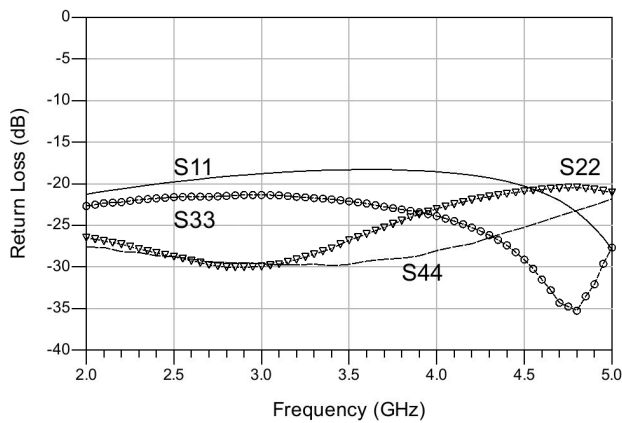

Isolation

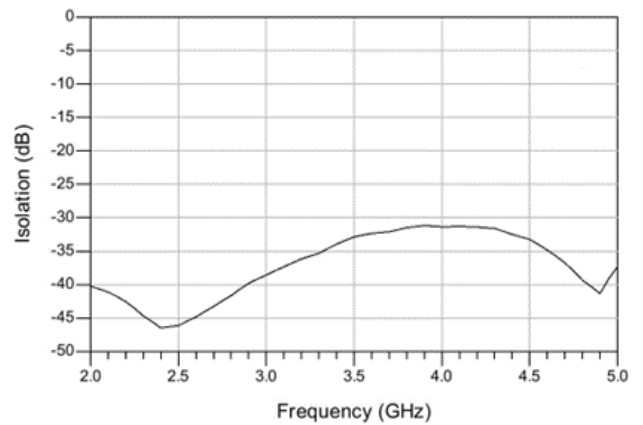

Insertion Loss

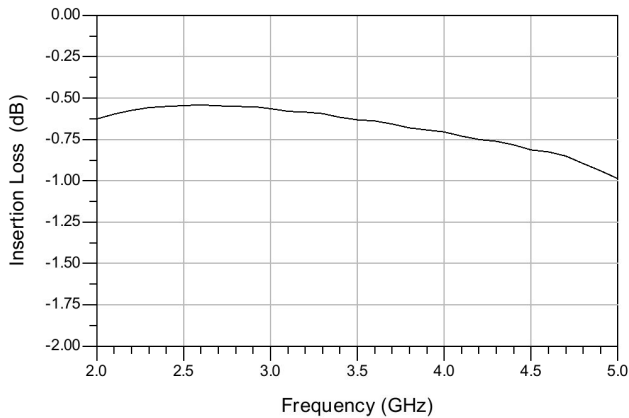

Die Outline Drawing

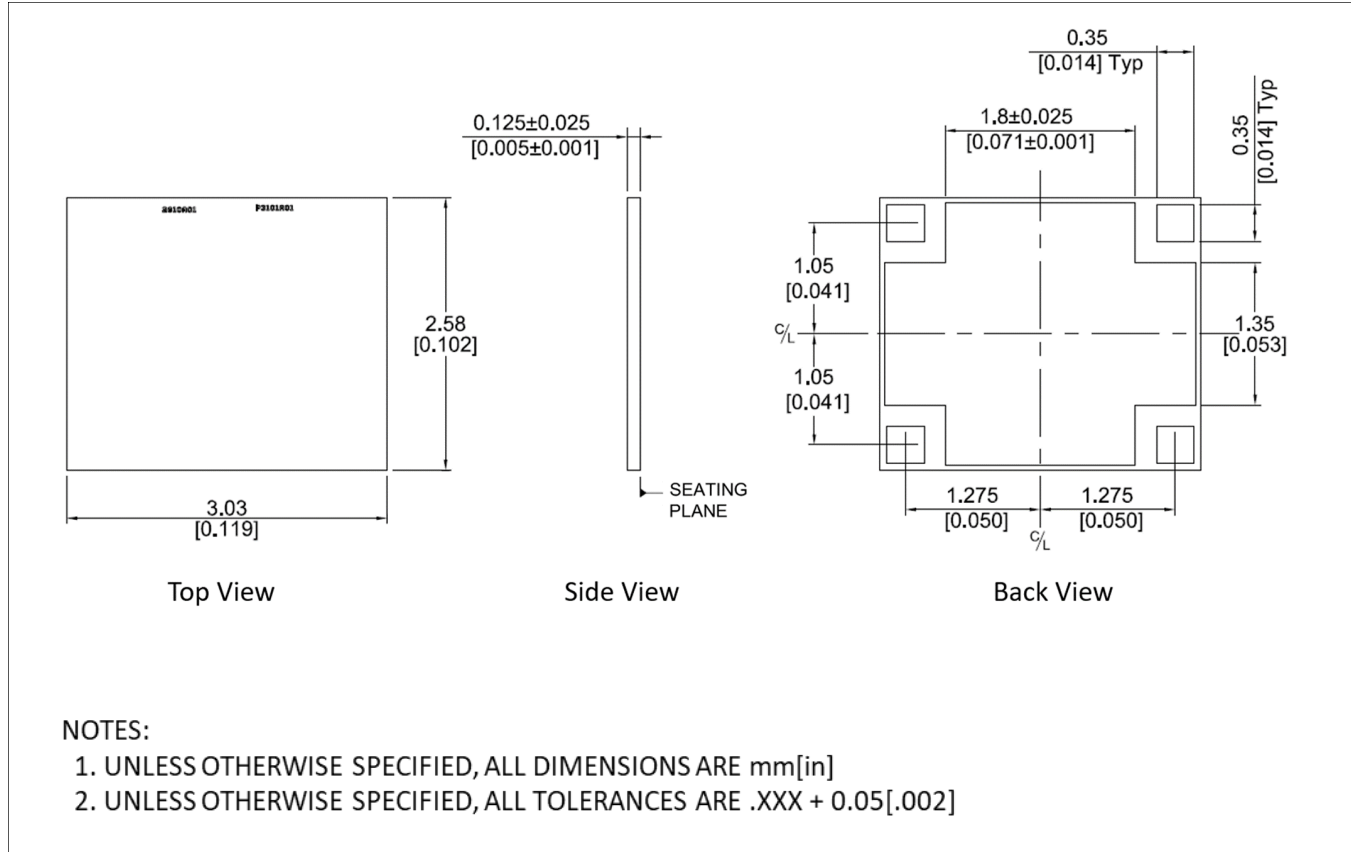

Mounting Techniques

Reference MACOM Application Note M538 for lead-free solder reflow recommendations. The gold plating on the back side of the die is 0.1 μm thick. For a suitable solder attach ensure the PCB is gold plated with a thickness of between 0.05 - 0.15 μm.

Static Sensitivity

These electronic devices are sensitive to electrostatic discharge (ESD) and can be damaged by static electricity. Proper ESD control techniques should be used when handling these devices.

90° Hybrid Coupler 2 - 5 GHz



MACP-011097
Rev. V2

Application Note¹⁰

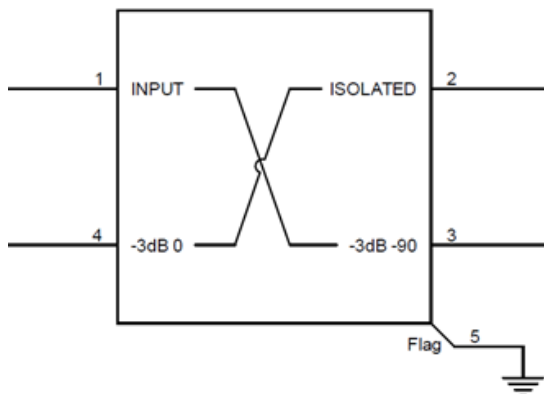

Configuration	Pin 1	Pin 2	Pin 3	Pin 4	Pin 5
Configuration 1	Input	Isolated	-3dB -90°	-3dB 0°	GND
Configuration 2	Isolated	Input	-3dB 0°	-3dB -90°	GND
Configuration 3	-3dB -90°	-3dB 0°	Input	Isolated	GND
Configuration 4	-3dB 0°	-3dB -90°	Isolated	Input	GND

10. Pin descriptions shown on diagram for Configuration 1.

AC Electrical Specifications: Freq. = 2 - 5 GHz, T_A = 25°C, Z₀ = 50 Ω

Parameter	Test Conditions	Units	Min.	Typ.	Max.
Insertion Loss	All Configurations	dB	—	0.75	—
Amplitude Balance	All Configurations	dB	—	1	—
Phase Balance from 90°	Configuration 1 Configuration 2	°	—	3 5	—
Isolation	Configurations 1 & 2	dB	—	30	—
Return Loss	All Ports & Configurations	dB	—	20	—

Typical Performance Curves: Configuration 3

Coupling

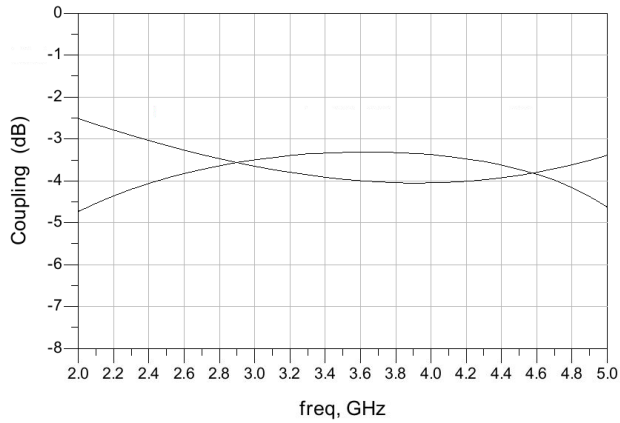

Phase Balance

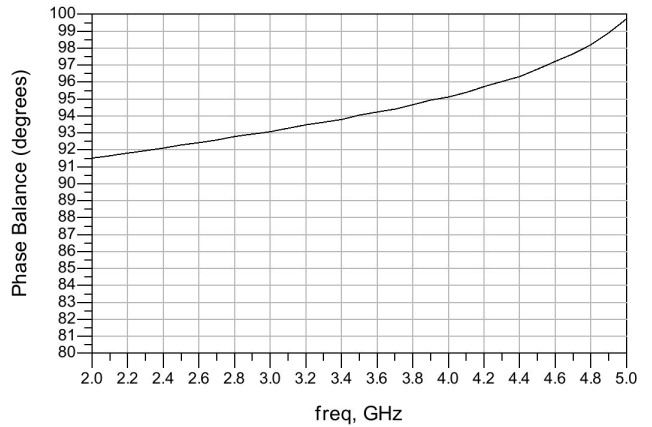

Return Losses

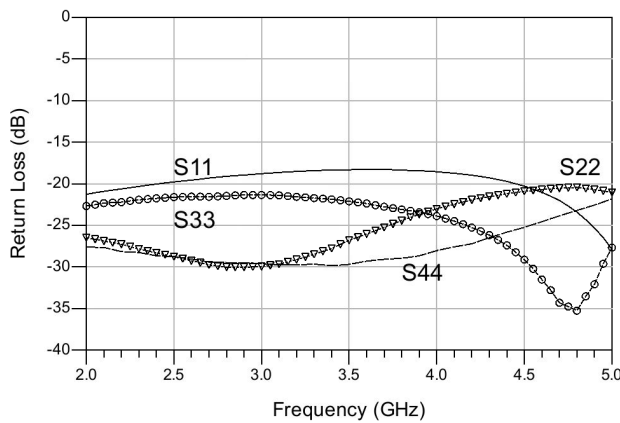

Isolation

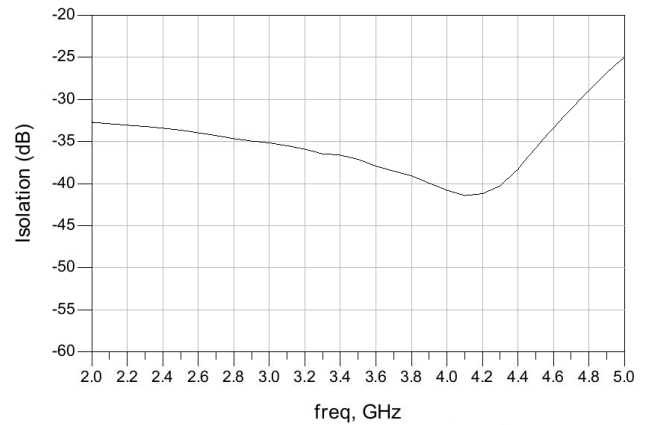

Insertion Loss

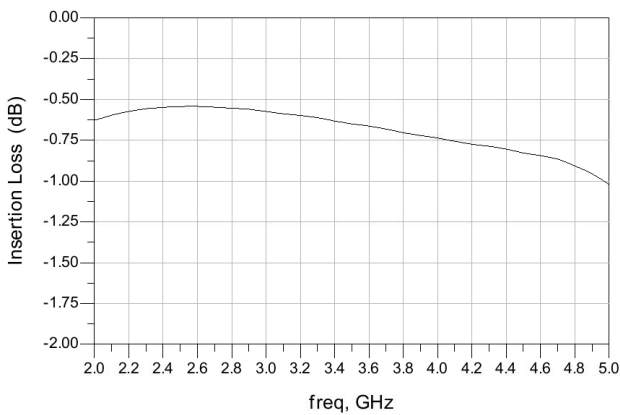

90° Hybrid Coupler 2 - 5 GHz



MACP-011097
Rev. V2

Typical Performance Curves: Configuration 4

Coupling

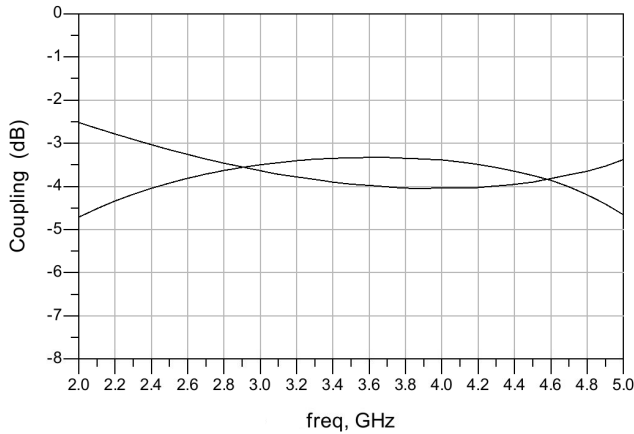

Phase Balance

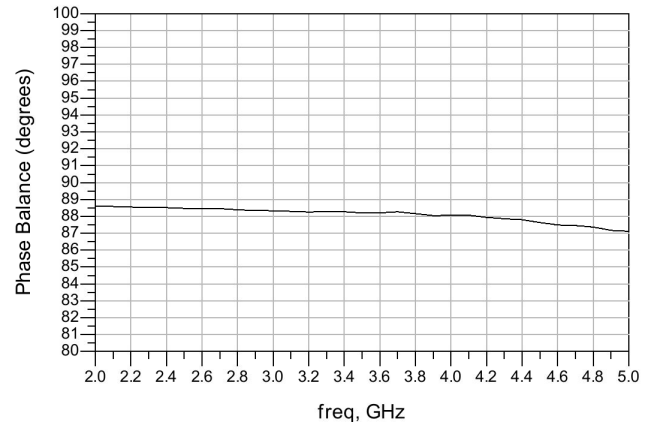

Return Losses

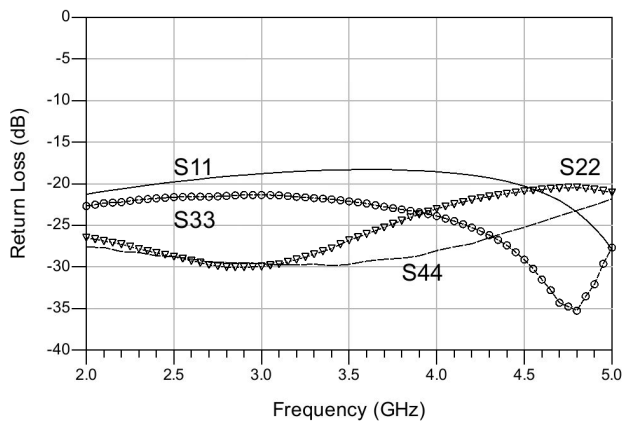

Isolation

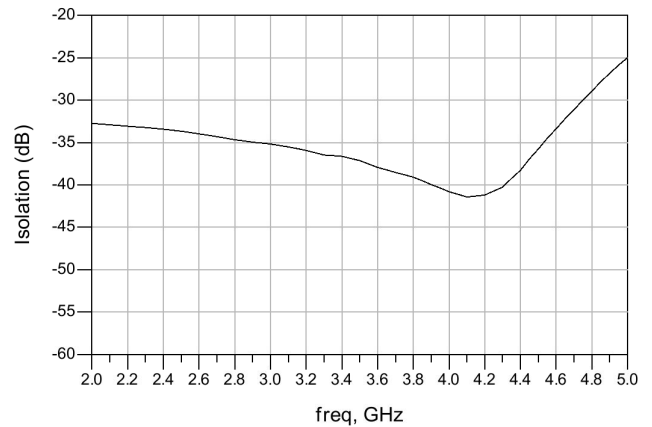

Insertion Loss

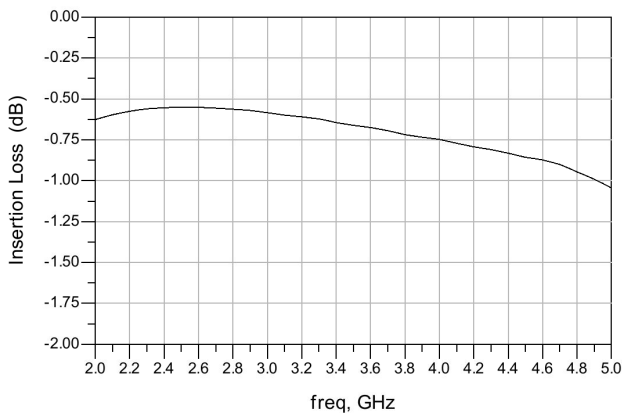

90° Hybrid Coupler

2 - 5 GHz



MACP-011097
Rev. V2

MACOM Technology Solutions Inc. ("MACOM"). All rights reserved.

These materials are provided in connection with MACOM's products as a service to its customers and may be used for informational purposes only. Except as provided in its Terms and Conditions of Sale or any separate agreement, MACOM assumes no liability or responsibility whatsoever, including for (i) errors or omissions in these materials; (ii) failure to update these materials; or (iii) conflicts or incompatibilities arising from future changes to specifications and product descriptions, which MACOM may make at any time, without notice. These materials grant no license, express or implied, to any intellectual property rights.

THESE MATERIALS ARE PROVIDED "AS IS" WITH NO WARRANTY OR LIABILITY, EXPRESS OR IMPLIED, RELATING TO SALE AND/OR USE OF MACOM PRODUCTS INCLUDING FITNESS FOR A PARTICULAR PURPOSE, MERCHANTABILITY, INFRINGEMENT OF INTELLECTUAL PROPERTY RIGHT, ACCURACY OR COMPLETENESS, OR SPECIAL, INDIRECT, INCIDENTAL, OR CONSEQUENTIAL DAMAGES WHICH MAY RESULT FROM USE OF THESE MATERIALS.

MACOM products are not intended for use in medical, lifesaving or life sustaining applications. MACOM customers using or selling MACOM products for use in such applications do so at their own risk and agree to fully indemnify MACOM for any damages resulting from such improper use or sale.