

E-Series RF 1:4 Flux Coupled Step-up Transformer 1 - 350 MHz

Rev. V2

Features

- 1:4 Impedance Ratio
- Surface Mount Package
- Centre Tap on Frequency
- Tape and Reel Packaging Available
- RoHS* Compliant & Lead Free

Description

The MABA-011020 is a RoHS compliant 1:4 RF flux coupled step-up transformer in a surface mount package.

Ideally suited for CATV application.

Schematic

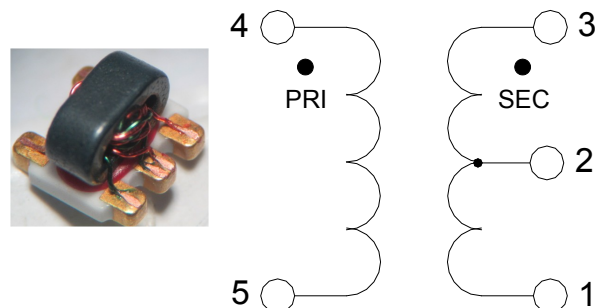

Pin Configuration

Pin #	Function	Pin #	Function
1	Secondary	4	Primary Dot
2	Secondary CT	5	Primary
3	Secondary Dot		

Electrical Specifications: Freq. = 1 - 350 MHz, $T_A = 25^\circ\text{C}$, $Z_0 = 50 \Omega$, $P_{IN} = 0 \text{ dBm}$

Parameter	Freq. Test Conditions (MHz)	Units	Min.	Typ.	Max.
Insertion Loss	5 - 100	dB	—	0.5	1.0
	2 - 300			0.9	2.0
	1 - 350			0.8	3.0
Amplitude Balance	5 - 100	dB	—	0.0	± 0.1
	1 - 350			0.0	± 0.5
Phase Balance	5 - 100	°	—	0.1	± 1.0
	1 - 350			0.2	± 5.0

Ordering Information

Parameter	Package
MABA-011020	2000 piece reel
MABA-011020-TB	customer evaluation board

Absolute Maximum Ratings

Parameter	Absolute Maximum
RF Power	250 mW
DC Current	30 mA
Operating Temperature	-40°C to +85°C

Typical Performance Curves

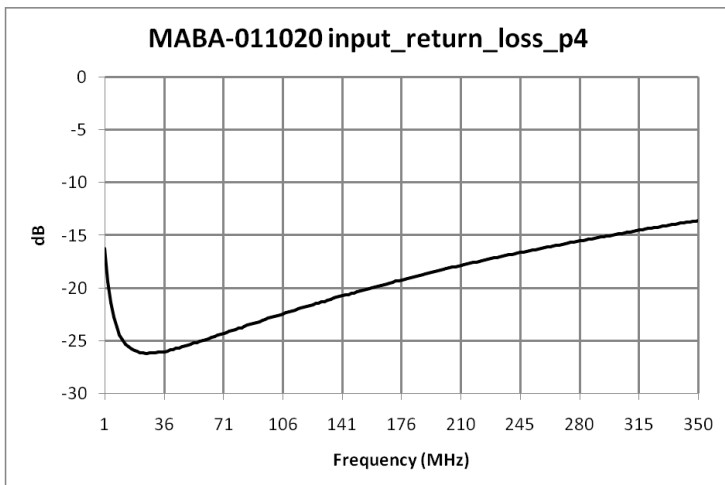
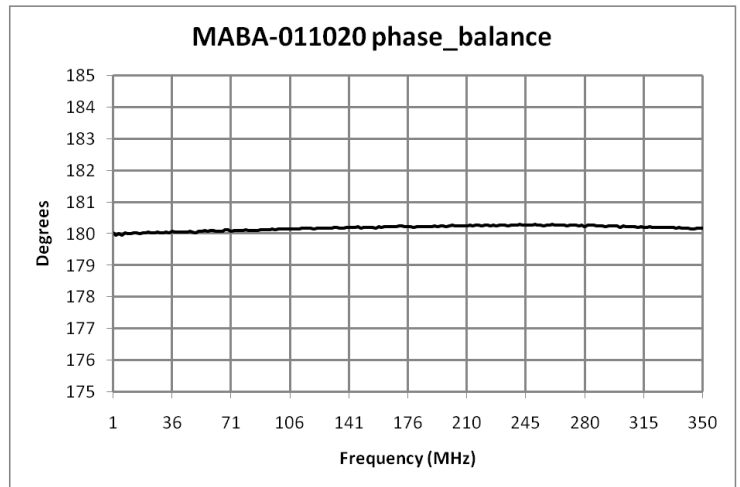
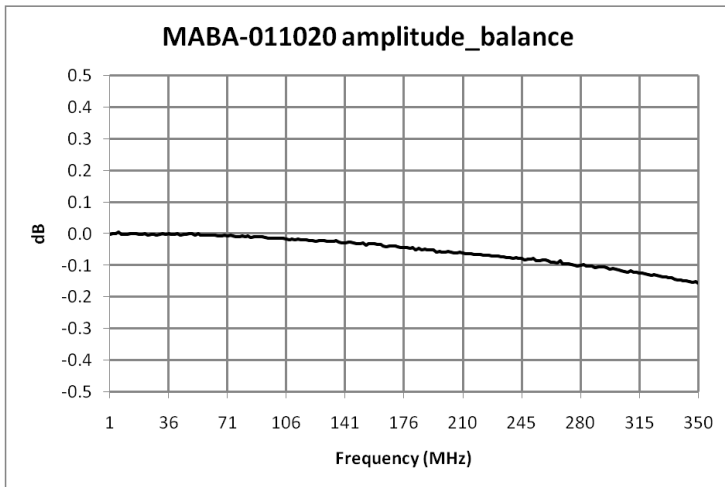
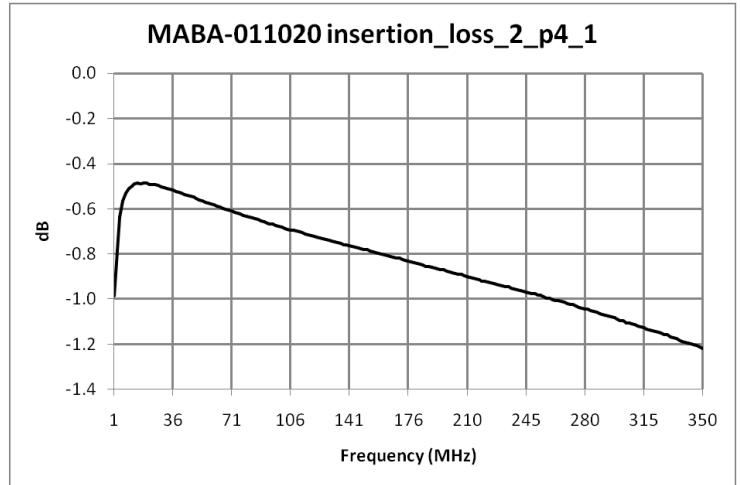
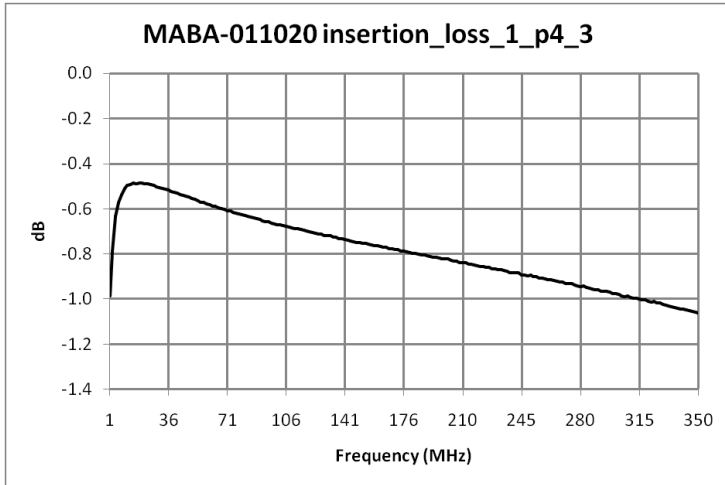

Application Circuit

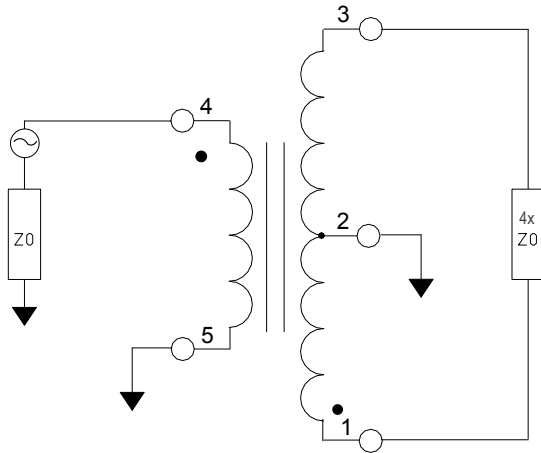

Outline Drawing

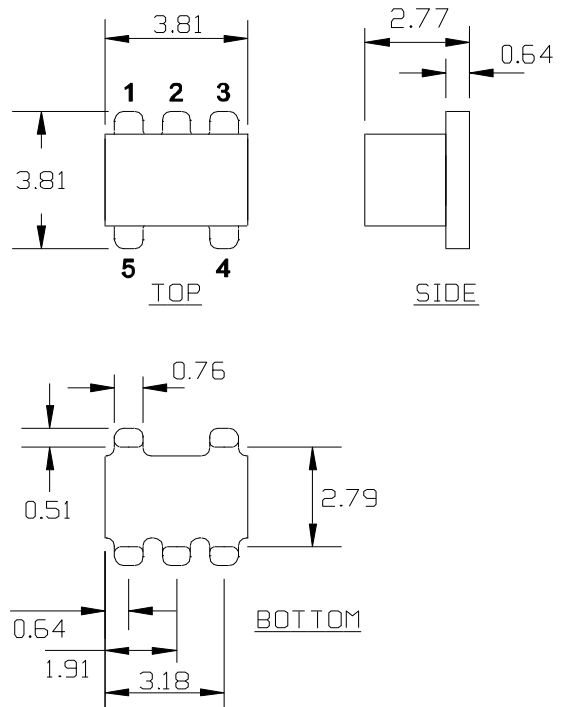

Recommended Footprint

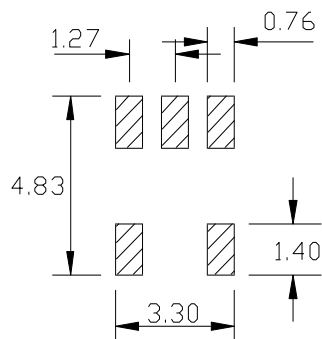

1. Dimensions in mm.
2. Tolerance: ± 0.2 mm unless otherwise noted.
3. Model number and lot code printed on reel.
4. Plating finish: Au

Tape & Reel Information

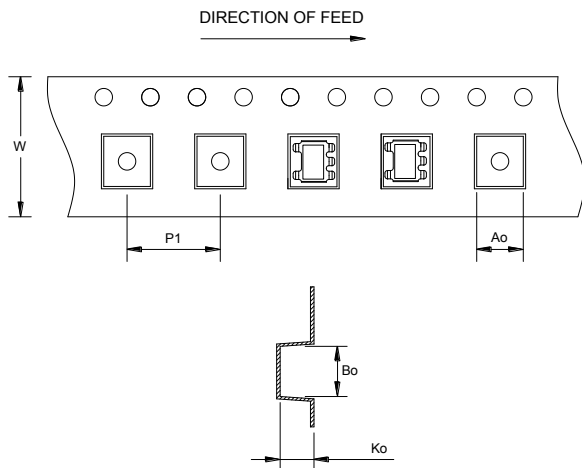

Dimensions

Item	Dimension (mm)
A _o	4.00 +/-0.1
B _o	4.00 +/-0.1
K _o	2.90 +/-0.1
W	12.00 +/-0.3
P1	8.00 +/-0.1
Orientation	F5
Reference Application note ANI-019 for orientation	

MACOM Technology Solutions Inc. All rights reserved.

Information in this document is provided in connection with MACOM Technology Solutions Inc ("MACOM") products. These materials are provided by MACOM as a service to its customers and may be used for informational purposes only. Except as provided in MACOM's Terms and Conditions of Sale for such products or in any separate agreement related to this document, MACOM assumes no liability whatsoever. MACOM assumes no responsibility for errors or omissions in these materials. MACOM may make changes to specifications and product descriptions at any time, without notice. MACOM makes no commitment to update the information and shall have no responsibility whatsoever for conflicts or incompatibilities arising from future changes to its specifications and product descriptions. No license, express or implied, by estoppel or otherwise, to any intellectual property rights is granted by this document.

THESE MATERIALS ARE PROVIDED "AS IS" WITHOUT WARRANTY OF ANY KIND, EITHER EXPRESS OR IMPLIED, RELATING TO SALE AND/OR USE OF MACOM PRODUCTS INCLUDING LIABILITY OR WARRANTIES RELATING TO FITNESS FOR A PARTICULAR PURPOSE, CONSEQUENTIAL OR INCIDENTAL DAMAGES, MERCHANTABILITY, OR INFRINGEMENT OF ANY PATENT, COPYRIGHT OR OTHER INTELLECTUAL PROPERTY RIGHT. MACOM FURTHER DOES NOT WARRANT THE ACCURACY OR COMPLETENESS OF THE INFORMATION, TEXT, GRAPHICS OR OTHER ITEMS CONTAINED WITHIN THESE MATERIALS. MACOM SHALL NOT BE LIABLE FOR ANY SPECIAL, INDIRECT, INCIDENTAL, OR CONSEQUENTIAL DAMAGES, INCLUDING WITHOUT LIMITATION, LOST REVENUES OR LOST PROFITS, WHICH MAY RESULT FROM THE USE OF THESE MATERIALS.

MACOM products are not intended for use in medical, lifesaving or life sustaining applications. MACOM customers using or selling MACOM products for use in such applications do so at their own risk and agree to fully indemnify MACOM for any damages resulting from such improper use or sale.