

# MABA-010655-CF1A40



1:1 10/10Base-T Ethernet Transformer  
1 - 100 MHz

V4

## Features

- Surface Mount
- 1:1 Impedance
- Suited for both R<sub>X</sub> & T<sub>X</sub> Channel
- Available on Tape and Reel
- RoHS Compliant and Pb Free
- 260°C Reflow Compatible

## Description

The MABA-010655-CF1A40 is a 10/100BASE-T Ethernet Transformer surface mount package.

Ideally suited for CATV Broadband applications.

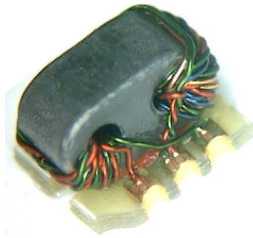

## Functional Schematic

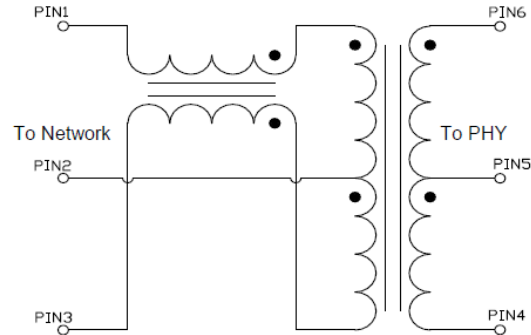

## Pin Configuration

Pin No.	Function
1	Primary Dot
2, 5	Ground
3	Primary
4	Secondary
6	Secondary Dot

Electrical Specifications: Freq. = 50 - 1200 MHz, T<sub>A</sub> = 25°C, Z<sub>0</sub> = 50 Ω, P<sub>in</sub> = 0 dBm

Parameter	Conditions	Units	Min.	Typ.	Max.
Impedance Ratio	—	ratio	—	1:1	—
Insertion Loss	1 - 3 MHz	dB	-0.25	-0.20	—
	3 - 10 MHz		-0.50	-0.20	
	10 - 65 MHz		-0.50	-0.30	
	65 - 100 MHz		-0.60	-0.43	
Return Loss	1 - 100 MHz	dB	—	-30	-20
Differential to Common Mode Rejection	1 - 100 MHz	dB	—	-37	-35
DC Resistance Balance	—	%	—	1.5	3.5

## Ordering Information

Part Number	Description
MABA-010655-CF1A40	900 piece reel
MABA-010655-CF1ATB	sample board

## Absolute Maximum Ratings

Parameter	Absolute Maximum
Input RF Power	250 mW
DC Current	600 mA
Operating Temperature	-40°C to +110°C
Storage Temperature	-55°C to +100°C

# MABA-010655-CF1A40



1:1 10/10Base-T Ethernet Transformer  
1 - 100 MHz

V4

Typical Performance Curves:  $T_A = 25^\circ\text{C}$ ,  $Z_0 = 50 \Omega$ ,  $P_{IN} = 0 \text{ dBm}$

Insertion Loss

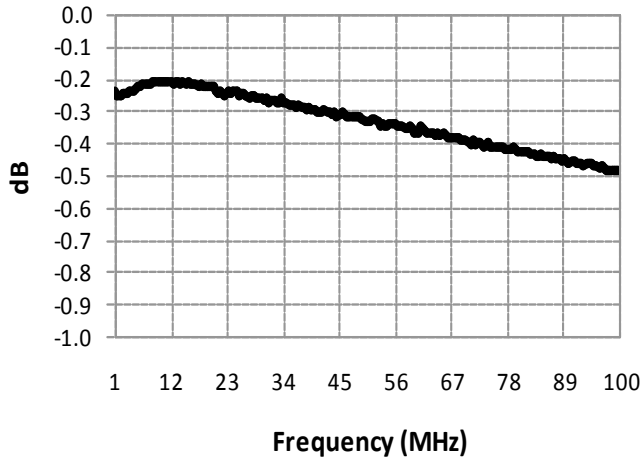

Input Return Loss

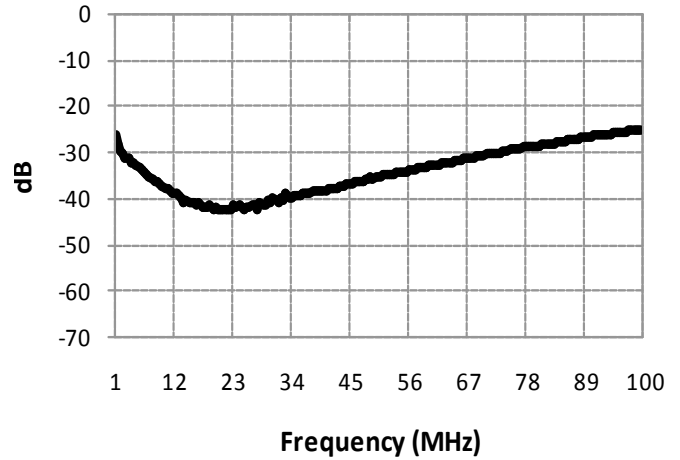

Differential to Common Mode Rejection

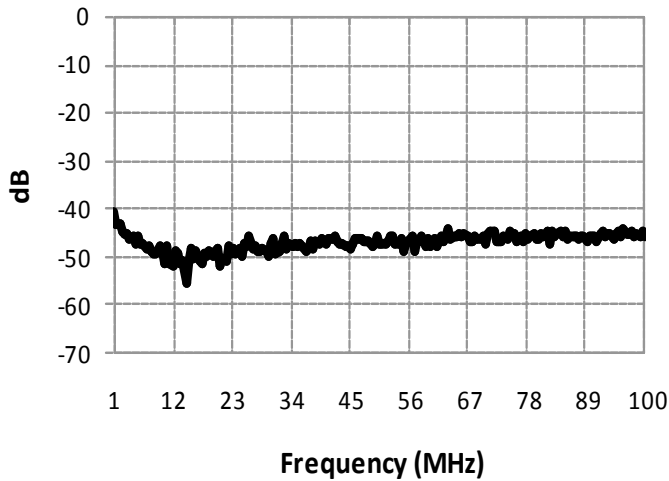

Output Return Loss

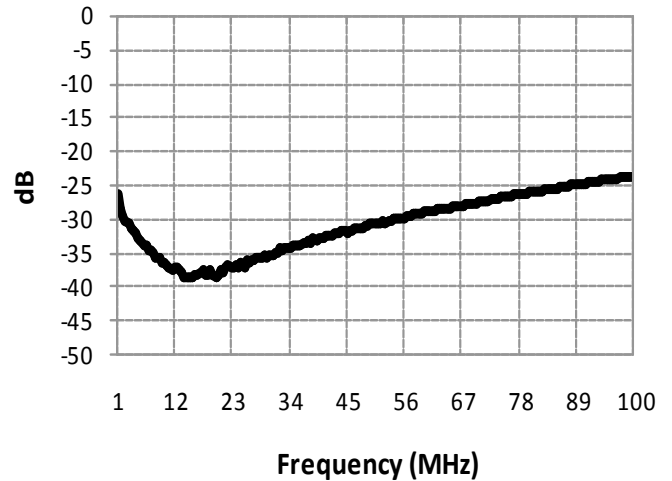

Full temperature plots available on request

## Application Circuit

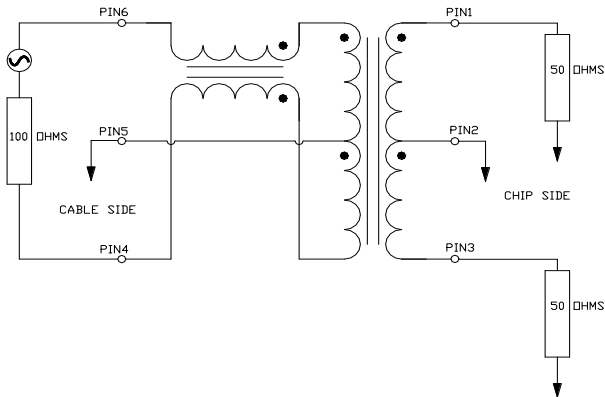

## Recommended Board Layout

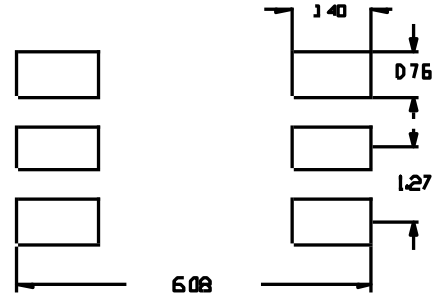

## Outline Drawing

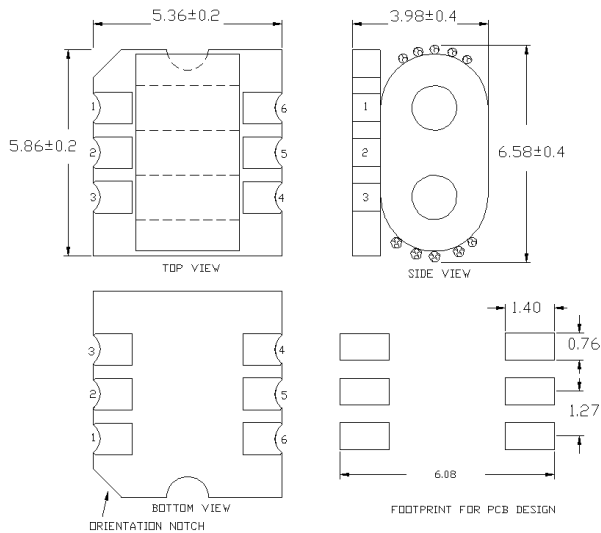

## Tape & Reel Information

Parameter	Units	Value
Qty per reel	-	900
Reel Size	mm	330
Tape Width	mm	16.00
Pitch	mm	8.00
Ao	mm	5.70
Bo	mm	7.00
Ko	mm	4.20
Orientation	-	F46
Reference Application Note ANI-019 for orientation		

Dimensions in mm.  
 Tolerance:  $\pm 0.2$  mm unless otherwise noted.  
 Model number and lot code printed on reel.  
 Plating finish: ENIG on both sides, 0.05 to 0.1  $\mu\text{m}$  gold over 3 to 6  $\mu\text{m}$  nickel

MACOM Technology Solutions Inc. All rights reserved.

Information in this document is provided in connection with MACOM Technology Solutions Inc ("MACOM") products. These materials are provided by MACOM as a service to its customers and may be used for informational purposes only. Except as provided in MACOM's Terms and Conditions of Sale for such products or in any separate agreement related to this document, MACOM assumes no liability whatsoever. MACOM assumes no responsibility for errors or omissions in these materials. MACOM may make changes to specifications and product descriptions at any time, without notice. MACOM makes no commitment to update the information and shall have no responsibility whatsoever for conflicts or incompatibilities arising from future changes to its specifications and product descriptions. No license, express or implied, by estoppel or otherwise, to any intellectual property rights is granted by this document.

THESE MATERIALS ARE PROVIDED "AS IS" WITHOUT WARRANTY OF ANY KIND, EITHER EXPRESS OR IMPLIED, RELATING TO SALE AND/OR USE OF MACOM PRODUCTS INCLUDING LIABILITY OR WARRANTIES RELATING TO FITNESS FOR A PARTICULAR PURPOSE, CONSEQUENTIAL OR INCIDENTAL DAMAGES, MERCHANTABILITY, OR INFRINGEMENT OF ANY PATENT, COPYRIGHT OR OTHER INTELLECTUAL PROPERTY RIGHT. MACOM FURTHER DOES NOT WARRANT THE ACCURACY OR COMPLETENESS OF THE INFORMATION, TEXT, GRAPHICS OR OTHER ITEMS CONTAINED WITHIN THESE MATERIALS. MACOM SHALL NOT BE LIABLE FOR ANY SPECIAL, INDIRECT, INCIDENTAL, OR CONSEQUENTIAL DAMAGES, INCLUDING WITHOUT LIMITATION, LOST REVENUES OR LOST PROFITS, WHICH MAY RESULT FROM THE USE OF THESE MATERIALS.

MACOM products are not intended for use in medical, lifesaving or life sustaining applications. MACOM customers using or selling MACOM products for use in such applications do so at their own risk and agree to fully indemnify MACOM for any damages resulting from such improper use or sale.