

Features

- 1:1 Impedance Ratio
- Surface Mount Package
- Tape and Reel Packaging Available
- RoHS* Compliant & 260°C Reflow Compatible

Description

The MABA-010125-TC1113 is a RoHS compliant 1:1 RF transmission line transformer in a surface mount package. The windings are welded to the package substrate for improved reliability and to eliminate lead content.

Ideally suited for high volume cellular and wireless application.

Schematic

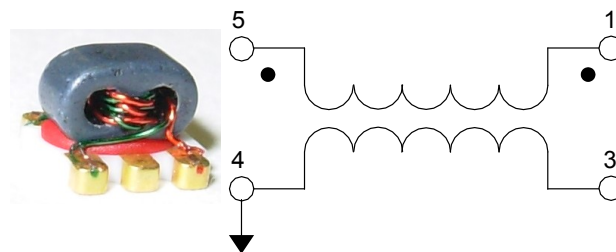

Pin Configuration

Pin #	Function	Pin #	Function
1	Secondary Dot	4	Primary
2	No Connection	5	Primary Dot
3	Secondary		

Electrical Specifications: Freq. = 4.5 - 3000 MHz, $T_A = 25^\circ\text{C}$, $Z_0 = 50 \Omega$, $P_{IN} = 0 \text{ dBm}$

Parameter	Freq. Test Conditions (MHz)	Units	Min.	Typ.	Max.
Insertion Loss	4.5 - 1000	dB	—	0.3	1.0
	1000 - 2000			1.5	2.0
	2000 - 3000			2.8	—
Amplitude Unbalance	4.5 - 3000	dB	—	0.5	1.0
Phase Unbalance	4.5 - 3000	°	—	5	20

Ordering Information

Parameter	Package
MABA-010125-TC1113	2000 piece reel

Absolute Maximum Ratings

Parameter	Absolute Maximum
RF Power	250 mW
DC Current	50 mA
Operating Temperature	-40°C to +85°C
Storage Temperature	-55°C to +125°C

Typical Performance Curves

Insertion Loss

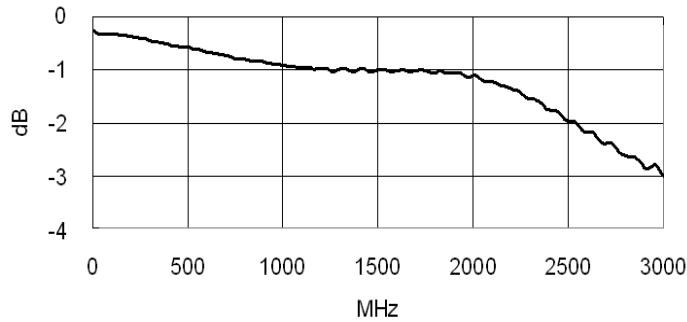

Input Return Loss

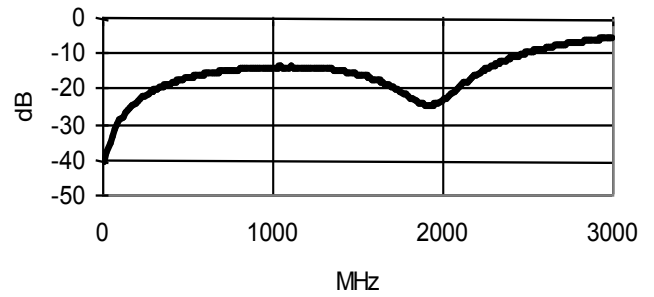

Amplitude Unbalance

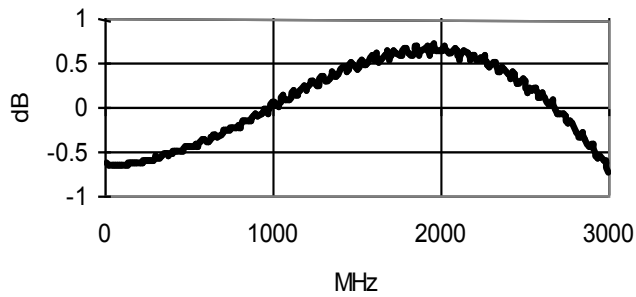

Phase Unbalance

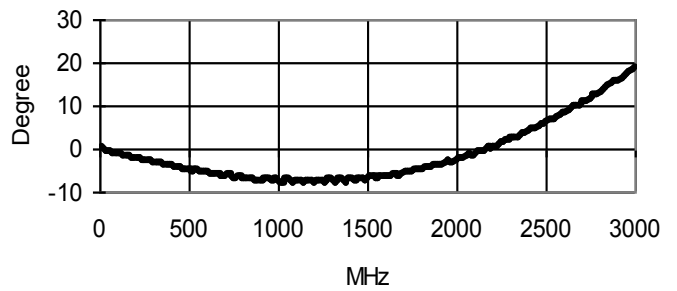

Outline Drawing

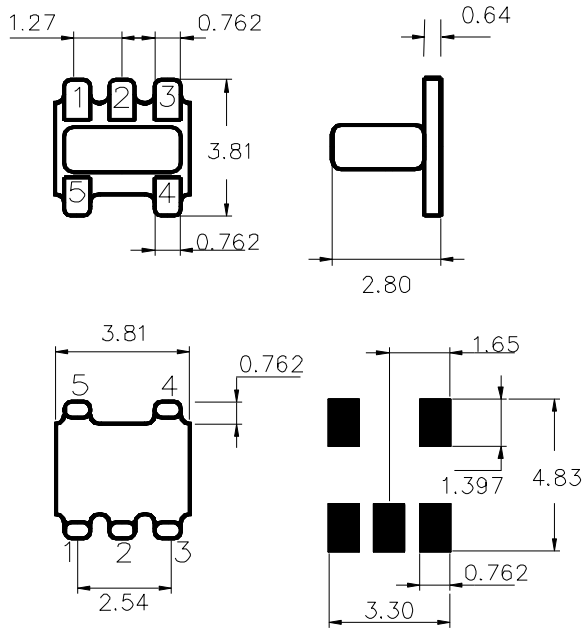

Dimensions are inches (millimeters) ± 0.015 (0.38) unless otherwise specified.
 Drawing not to scale.

Tape & Reel Information

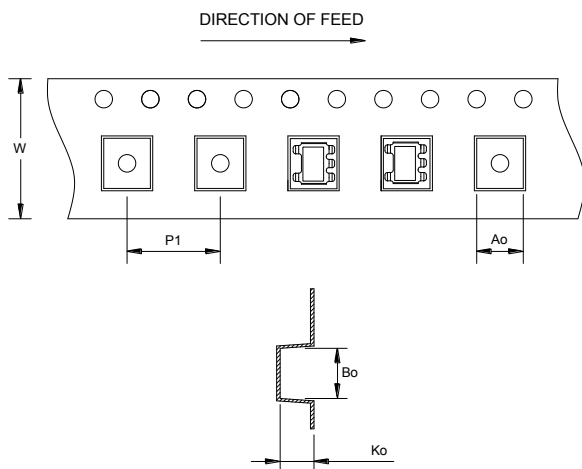

Dimensions

Item	Dimension (mm)
A _o	4.00 +/-0.1
B _o	4.00 +/-0.1
K _o	2.90 +/-0.1
W	12.00 +/-0.3
P1	8.00 +/-0.1

MACOM Technology Solutions Inc. All rights reserved.

Information in this document is provided in connection with MACOM Technology Solutions Inc ("MACOM") products. These materials are provided by MACOM as a service to its customers and may be used for informational purposes only. Except as provided in MACOM's Terms and Conditions of Sale for such products or in any separate agreement related to this document, MACOM assumes no liability whatsoever. MACOM assumes no responsibility for errors or omissions in these materials. MACOM may make changes to specifications and product descriptions at any time, without notice. MACOM makes no commitment to update the information and shall have no responsibility whatsoever for conflicts or incompatibilities arising from future changes to its specifications and product descriptions. No license, express or implied, by estoppel or otherwise, to any intellectual property rights is granted by this document.

THESE MATERIALS ARE PROVIDED "AS IS" WITHOUT WARRANTY OF ANY KIND, EITHER EXPRESS OR IMPLIED, RELATING TO SALE AND/OR USE OF MACOM PRODUCTS INCLUDING LIABILITY OR WARRANTIES RELATING TO FITNESS FOR A PARTICULAR PURPOSE, CONSEQUENTIAL OR INCIDENTAL DAMAGES, MERCHANTABILITY, OR INFRINGEMENT OF ANY PATENT, COPYRIGHT OR OTHER INTELLECTUAL PROPERTY RIGHT. MACOM FURTHER DOES NOT WARRANT THE ACCURACY OR COMPLETENESS OF THE INFORMATION, TEXT, GRAPHICS OR OTHER ITEMS CONTAINED WITHIN THESE MATERIALS. MACOM SHALL NOT BE LIABLE FOR ANY SPECIAL, INDIRECT, INCIDENTAL, OR CONSEQUENTIAL DAMAGES, INCLUDING WITHOUT LIMITATION, LOST REVENUES OR LOST PROFITS, WHICH MAY RESULT FROM THE USE OF THESE MATERIALS.

MACOM products are not intended for use in medical, lifesaving or life sustaining applications. MACOM customers using or selling MACOM products for use in such applications do so at their own risk and agree to fully indemnify MACOM for any damages resulting from such improper use or sale.