

# MABA-009109-CF1A40

1:1 Flux Coupled Balun Transformer  
5 - 120 MHz

M/A-COM Products  
Part Status: Released Rev V2

## Features

- Surface Mount
- 1:1 Impedance
- 75 Ohm
- RoHS Compliant

## Description

M/A-COM's MABA-009109-CF1A40 is a 1:1 RF flux coupled Transformer in a low cost surface mount package. Ideally suited for high volume CATV application.

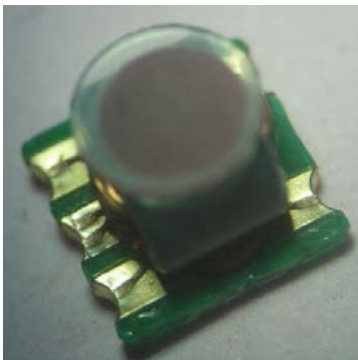

## Schematic

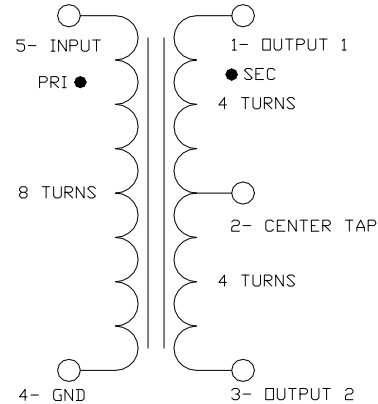

## Case Style SM-164A

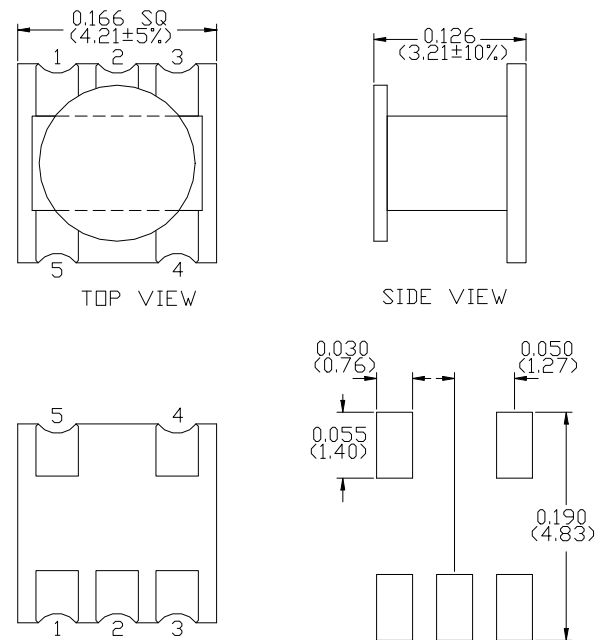

## Pin Configuration

Function	Pin Number
Secondary Dot (Output 1)	1
Secondary Centre Tap	2
Secondary (Output 2)	3
Primary (Ground)	4
Primary Dot (Input)	5

## Ordering Information

Part Number	Package
MABA-009109-CF1A40	2000 pieces per reel
MABA-009109-CF1ATB	Customer test board

## Electrical Specifications: $T_A = 25^\circ\text{C}$ , 0dBm, $Z_0 = 75\Omega$

Parameter	Test Conditions	Units	Min.	Typ.	Max.
Frequency Range	5 – 120 MHz				
Insertion Loss 1 (Pin 5 to Pin 1)	5 – 75 MHz	dB	–	0.1	0.4
	75 – 120 MHz	dB	–	0.3	0.6
Insertion Loss 2 (Pin 5 to Pin 3)	5 – 75 MHz	dB	–	0.2	0.4
	75 – 120 MHz	dB	–	0.4	0.5
Amplitude Un-Balance	5 – 75 MHz	dB	–	$\pm 0.03$	$\pm 0.17$
	75 – 120 MHz	dB	–	$\pm 0.12$	$\pm 0.38$
Phase Un-Balance	5 – 75 MHz	$^\circ$	–	$\pm 0.05$	$\pm 2.0$
	75 – 120 MHz	$^\circ$	–	$\pm 0.10$	$\pm 3.0$
Input Return Loss (Pin 5)	5 – 75 MHz	dB	20	28	–
	75 – 120 MHz	dB	15	19	–

## Absolute Maximum Ratings

Parameter	Absolute Maximum
RF Power	250mW
DC Current	30mA
Operating Temperature	$-40^\circ\text{C}$ to $+100^\circ\text{C}$
Storage Temperature	$-40^\circ\text{C}$ to $+100^\circ\text{C}$

## Recommended PCB Configuration

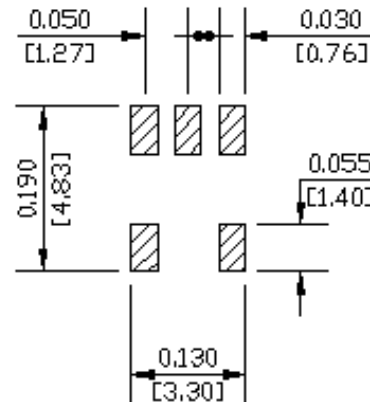

# MABA-009109-CF1A40



1:1 Flux Coupled Balun Transformer  
5 - 120 MHz

M/A-COM Products  
Part Status: Released Rev V2

Typical Performance:  $T_A = 25^\circ\text{C}$ , 0dBm,  $Z_0 = 75\Omega$

### Insertion Loss 1 (Pin 5 - Pin 1)

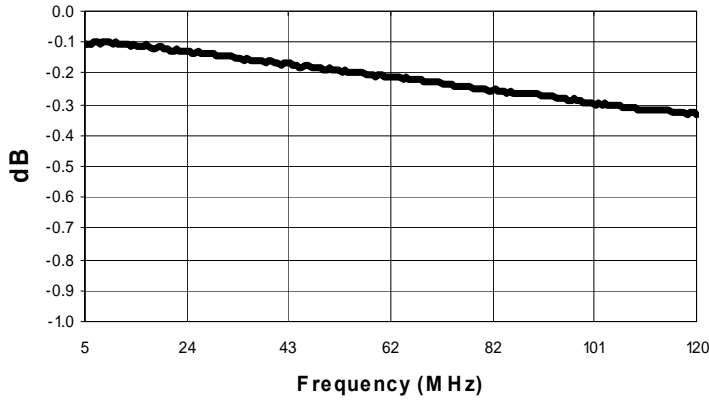

### Insertion Loss 2 (Pin 5 - Pin 3)

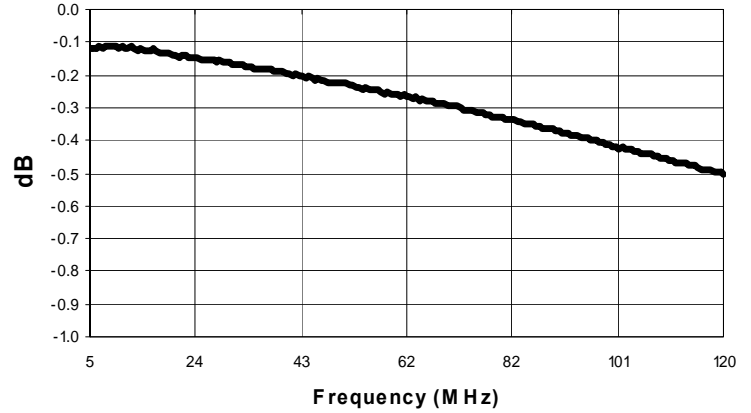

### Amplitude Balance

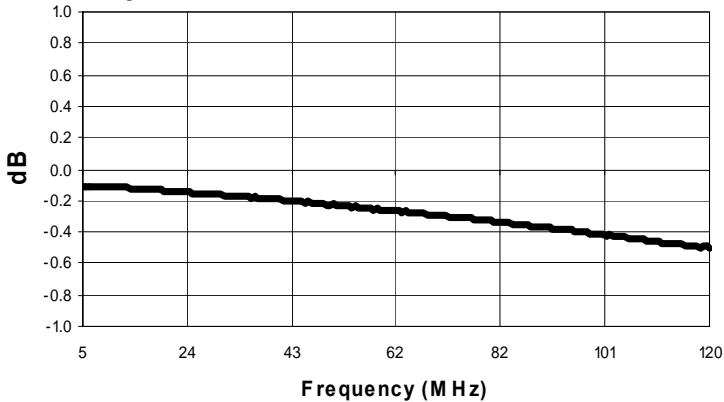

### Phase Balance

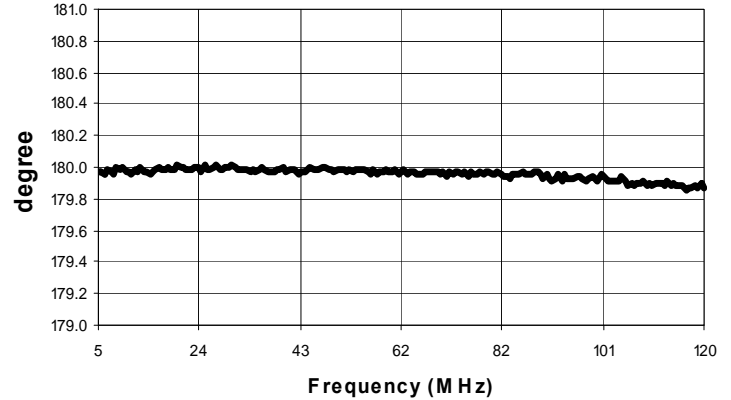

### Return Loss: Input (Pin 5)

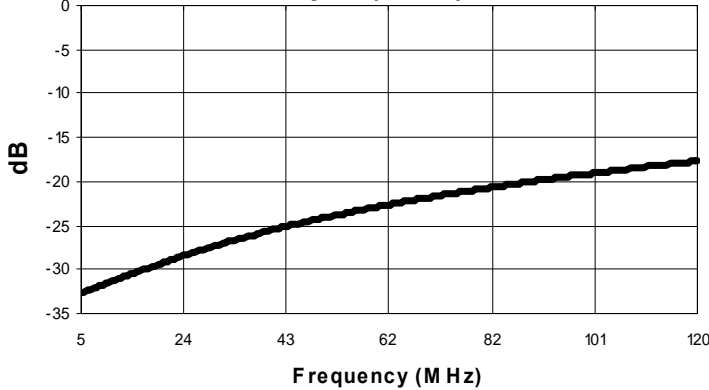

3

**ADVANCED:** Data Sheets contain information regarding a product M/A-COM Technology Solutions is considering for development. Performance is based on target specifications, simulated results, and/or prototype measurements. Commitment to develop is not guaranteed.

**PRELIMINARY:** Data Sheets contain information regarding a product M/A-COM Technology Solutions has under development. Performance is based on engineering tests. Specifications are typical. Mechanical outline has been fixed. Engineering samples and/or test data may be available. Commitment to produce in volume is not guaranteed.

• North America Tel: 800.366.2266 • Europe Tel: +353.21.244.6400  
• India Tel: +91.80.4155721 • China Tel: +86.21.2407.1588  
Visit [www.macomtech.com](http://www.macomtech.com) for additional data sheets and product information.

M/A-COM Technology Solutions Inc. and its affiliates reserve the right to make changes to the product(s) or information contained herein without notice.