

### Features

- 5.8 - 12 GHz Frequency Range
- 2 dB Insertion Loss @ 10 GHz
- >30 dB Attenuation Range
- High Linearity, 29 dBm IIP3
- Lead-Free 3 mm, 16-Lead QFN Package
- RoHS\* Compliant

### Description

The MAAT-010521-L2 is a voltage variable attenuator with analog control and >30 dB of attenuation. Excellent linearity is maintained over the full attenuation range. The attenuation level is set by two control voltages of 0 to -2 V. This device is assembled in a lead free 3 mm 16 lead PQFN plastic package.

Applications include transceivers for cellular infrastructure.

### Functional Block Diagram

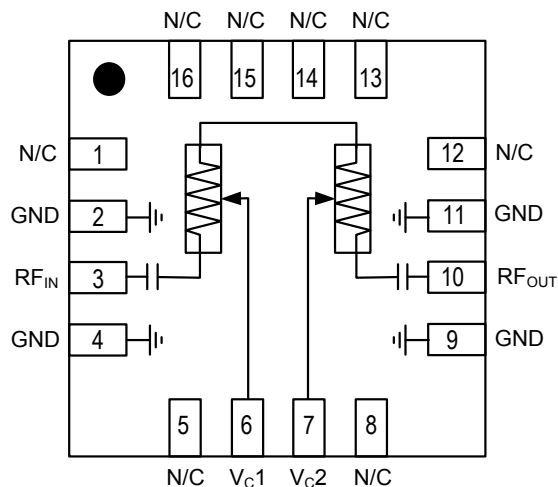

### Pin Configuration<sup>1,2</sup>

Pin #	Function
1, 5, 8, 12 - 16	No Connection
2, 4, 9, 11	Ground
3	RF Input
6	V <sub>C1</sub>
7	V <sub>C2</sub>
10	RF Output

1. It is recommended to connect No Connection (N/C) pins to ground.
2. The exposed pad centered on the package bottom must be connected to RF, DC and thermal ground.

### Ordering Information

Part Number	Package
MAAT-010521-L2TR05	500 Part Reel
MAAT-010521-L2TR1K	1000 Part Reel
MAAT-010521-L2BSMB	Sample Board

\* Restrictions on Hazardous Substances, compliant to current RoHS EU directive.

## Voltage Variable Attenuator 5.8 - 12 GHz

Rev. V1

**Electrical Specifications:  $T_A = +25^\circ\text{C}$ ,  $Z_0 = 50 \Omega$ ,  $P_{IN} = -10 \text{ dBm}$**

Parameter	Test Conditions	Units	Min.	Typ.	Max.
Insertion Loss ( $V_{C1} = V_{C2} = -2 \text{ V}$ )	5.8 - 7.1 GHz 7.1 - 8.5 GHz 10.0 - 12.0 GHz	dB	—	2.5 1.8 2.5	4
Attenuation ( $V_{C1} = V_{C2} = 0 \text{ V}$ ) <sup>3</sup>	5.8 - 7.1 GHz 7.1 - 8.5 GHz 10.0 - 12.0 GHz	dB	—	30.5 33 37	—
Dynamic Range	5.8 - 7.1 GHz 7.1 - 8.5 GHz 10.0 - 12.0 GHz	dB	25 27.5 31	28 31 34	—
Input P1dB <sup>4</sup>	5.8 - 12 GHz	dBm	20	22	—
IIP3	$P_{IN} = 12 \text{ dBm/tone @ } 5.8 - 12 \text{ GHz}$  $V_{C1} \leq 0 \text{ V} \ \& \ V_{C2} \leq -0.8 \text{ V}$ $V_{C1} = 0 \text{ V} \ \& \ V_{C2} > -0.8 \text{ V}$ $V_{C1} = V_{C2} = -2 \text{ V}$	dBm	26 27.8 35	29 31 40	—
Input Return Loss	—	dB	—	10	—
Output Return Loss	—	dB	—	10	—

3. To increase attenuation from minimum attenuation state ( $V_{C1} = -2 \text{ V}$  and  $V_{C2} = -2 \text{ V}$ ) to maximum attenuation state ( $V_{C1} = 0 \text{ V}$  and  $V_{C2} = 0 \text{ V}$ ),  $V_{C1}$  increases to full range prior to adjusting  $V_{C2}$ .

4. Guaranteed on MACOM Sample Board only.

### Absolute Maximum Ratings<sup>5,6</sup>

Parameter	Absolute Maximum
Input Power	30 dBm
Voltage (RF pins)	30 V
Voltage (control pins)	+1 V to -6 V
Storage Temperature	-55°C to +150°C
Case Temperature	-40°C to +85°C

5. Exceeding any one or combination of these limits may cause permanent damage to this device.

6. MACOM does not recommend sustained operation near these survivability limits.

### Handling Procedures

The following precautions should be observed to avoid damage:

### Static Sensitivity

Gallium Arsenide Integrated Circuits are sensitive to electrostatic discharge (ESD) and can be damaged by static electricity. Proper ESD control techniques should be used when handling these HBM Class 1A devices.

## Voltage Variable Attenuator 5.8 - 12 GHz

Rev. V1

### Typical Performance Curves: @ +25°C

**Gain**

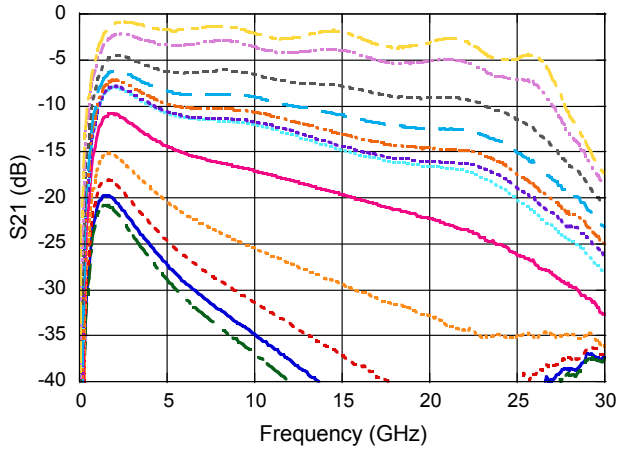

**Input Return Loss**

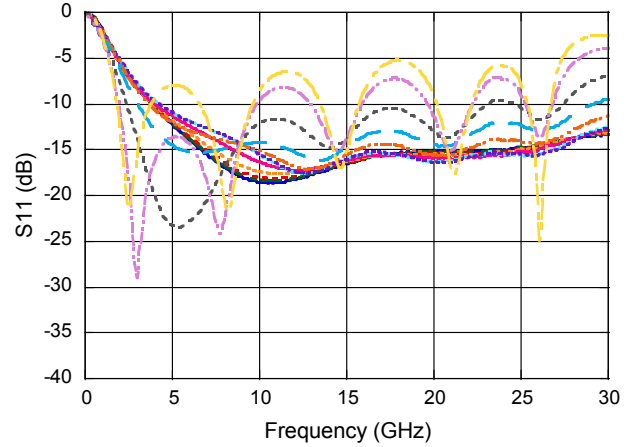

**Output Return Loss**

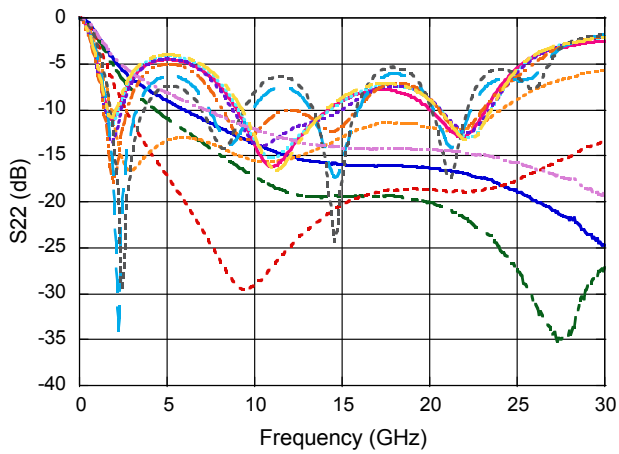

- VC1=0, VC2=0
- - VC1=0, VC2=0.2
- - - VC1=0, VC2=0.4
- - - - VC1=0, VC2=0.6
- VC1=0, VC2=0.8
- · - · VC1=0, VC2=1.0
- · - · - VC1=0, VC2=2.0
- · - · - - VC1=0.2, VC2=2.0
- · - · - - - VC1=0.4, VC2=2.0
- · - · - - - - VC1=0.6, VC2=2.0
- · - · - - - - - VC1=0.8, VC2=2.0
- · - · - - - - - - VC1=2.0, VC2=2.0

**Dynamic Range**

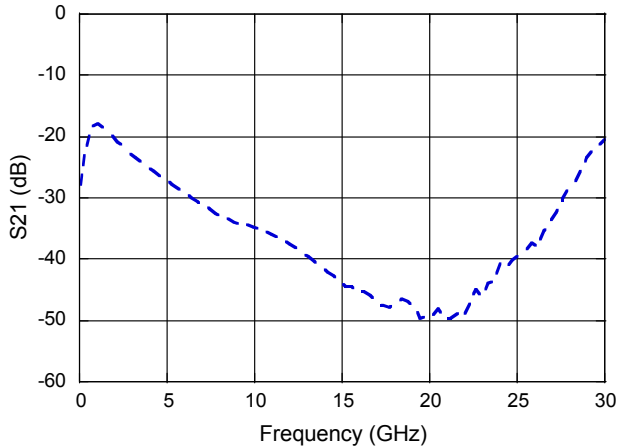

## Voltage Variable Attenuator 5.8 - 12 GHz

Rev. V1

### Typical Performance Curves: S-Parameters @ +25°C

**S-Parameters  $V_{C1} = -2.0\text{ V}$ ,  $V_{C2} = -2.0\text{ V}$**

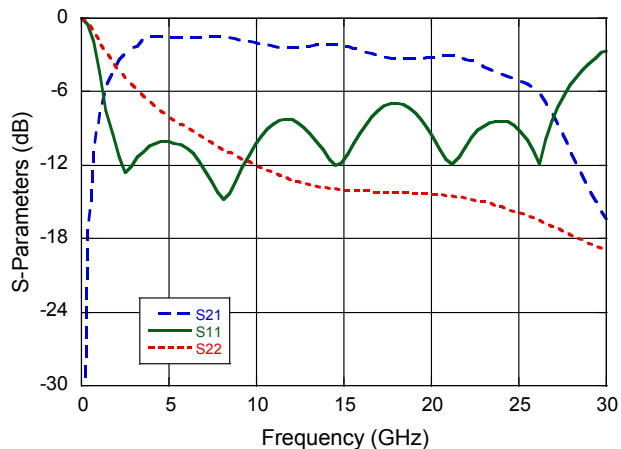

**S-Parameters  $V_{C1} = -0.6\text{ V}$ ,  $V_{C2} = -2.0\text{ V}$**

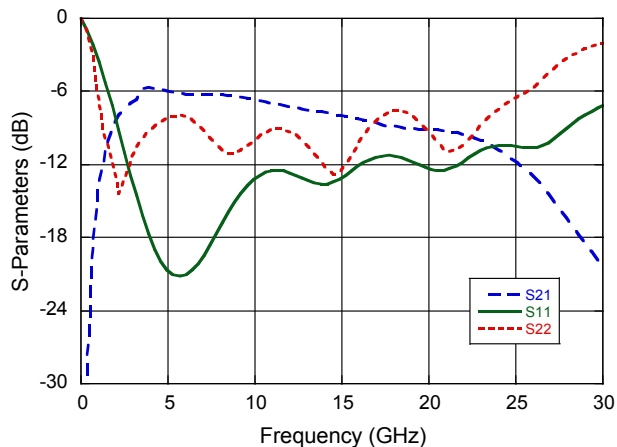

**S-Parameters  $V_{C1} = -0.4\text{ V}$ ,  $V_{C2} = -2.0\text{ V}$**

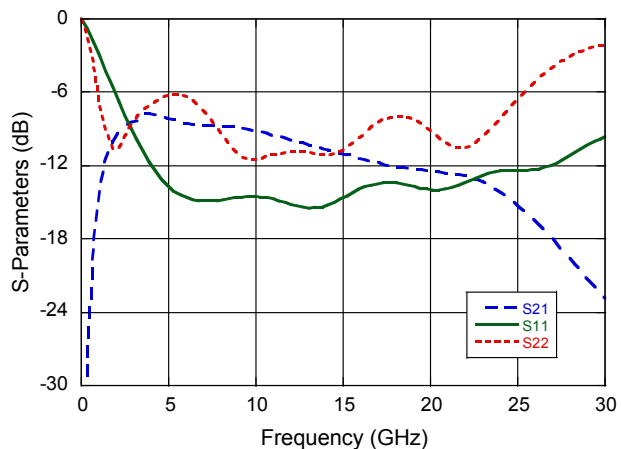

**S-Parameters  $V_{C1} = -0.2\text{ V}$ ,  $V_{C2} = -2.0\text{ V}$**

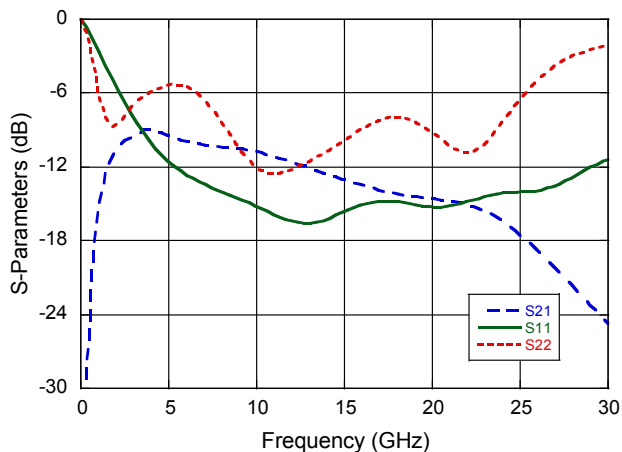

**S-Parameters  $V_{C1} = 0\text{ V}$ ,  $V_{C2} = -0.6\text{ V}$**

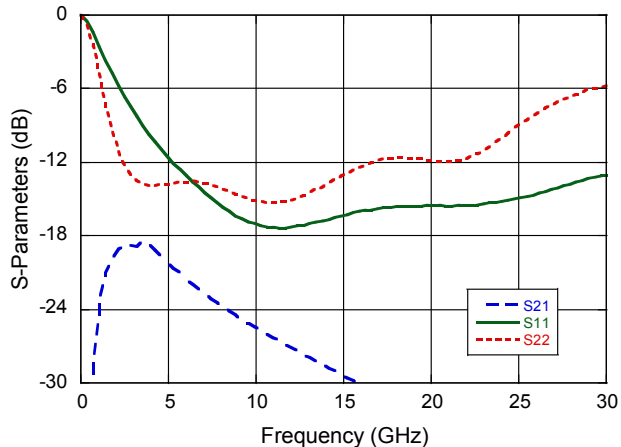

## Voltage Variable Attenuator 5.8 - 12 GHz

Rev. V1

### Typical Performance Curves: Power Gain @ +25°C

Power Gain @  $V_{C1} = -2.0\text{ V}$ ,  $V_{C2} = -2.0\text{ V}$

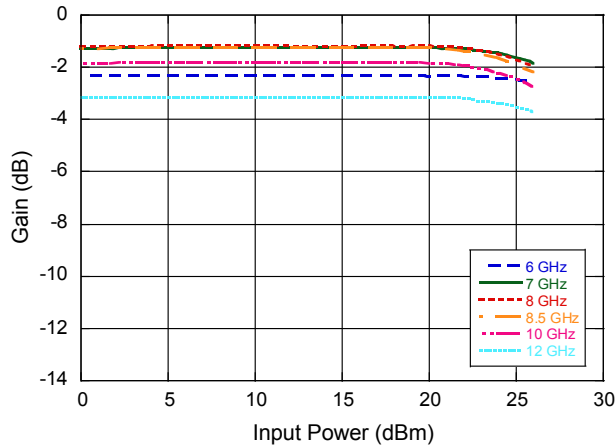

Power Gain @  $V_{C1} = 0\text{ V}$ ,  $V_{C2} = -2.0\text{ V}$

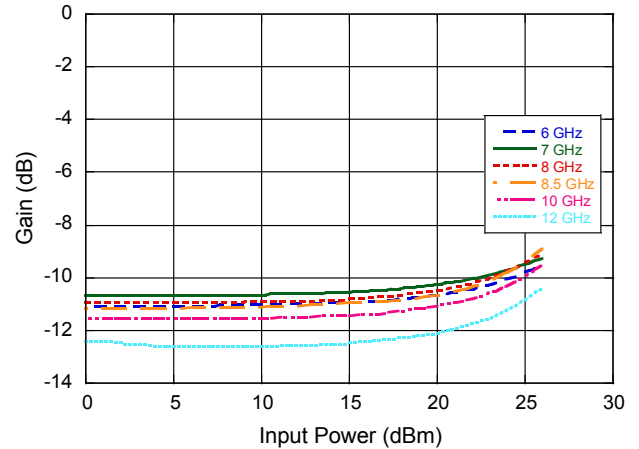

Power Gain @  $V_{C1} = -0.4\text{ V}$ ,  $V_{C2} = -2.0\text{ V}$

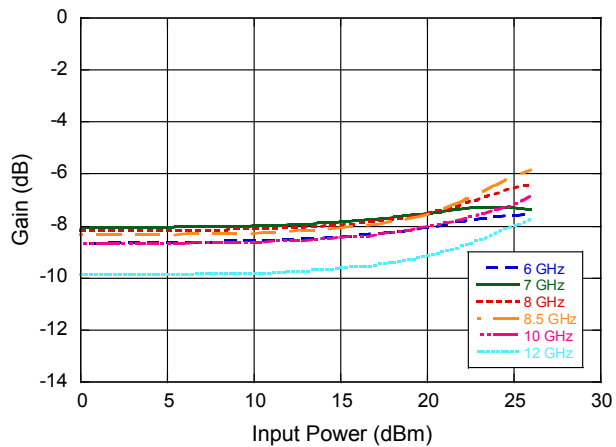

Power Gain @  $V_{C1} = 0\text{ V}$ ,  $V_{C2} = -0.6\text{ V}$

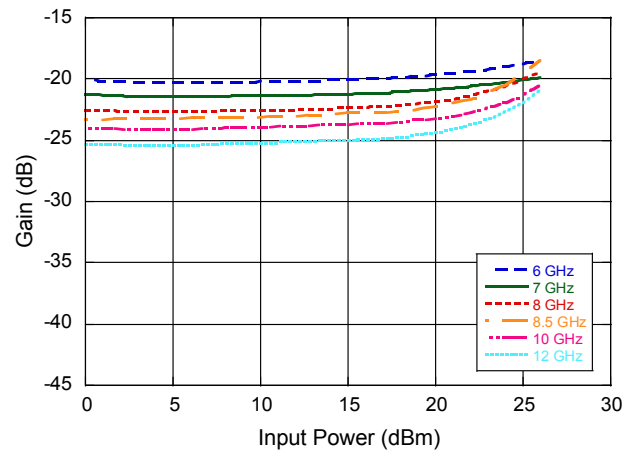

Power Gain @  $V_{C1} = 0\text{ V}$ ,  $V_{C2} = 0\text{ V}$

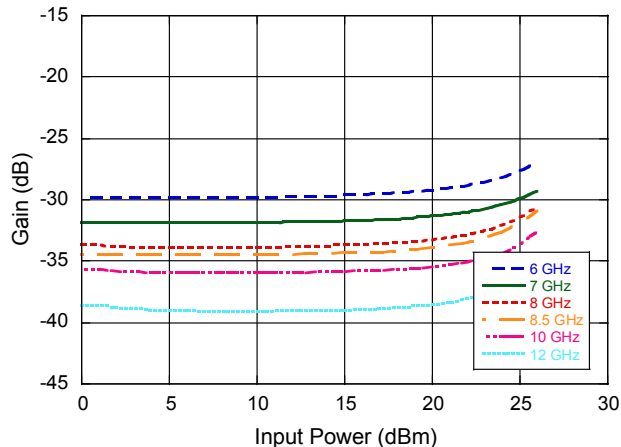

### Typical Performance Curves: Input IP3

**Input IP3 vs. Frequency**  
@  $V_{C1} = -2.0\text{ V}$ ,  $V_{C2} = -2.0\text{ V}$

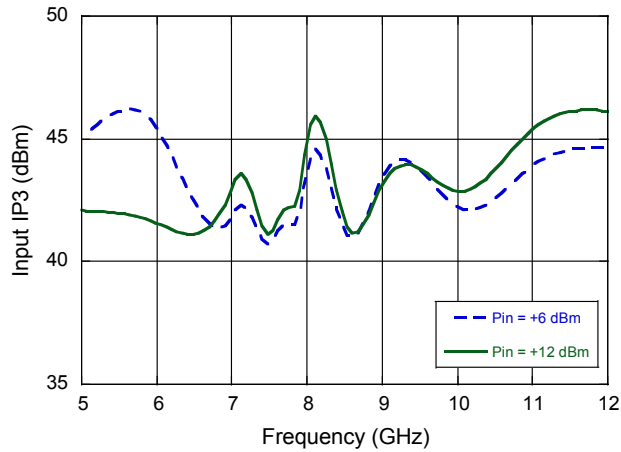

**Input IP3 vs. SCL Input Power**  
@  $V_{C1} = -2.0\text{ V}$ ,  $V_{C2} = -2.0\text{ V}$

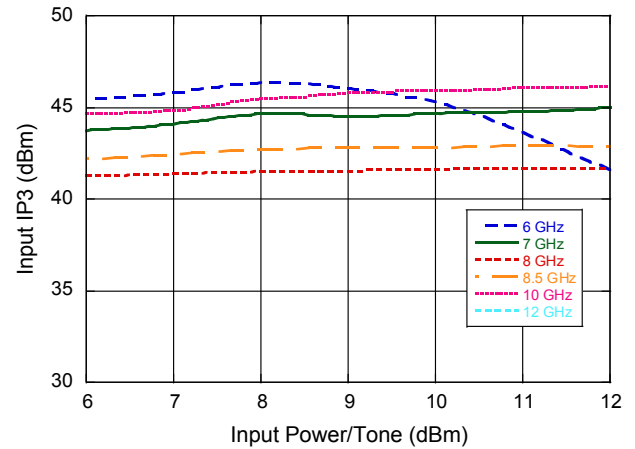

**Input IP3 vs. Attenuation, SCL  $P_{IN} = 6\text{ dBm}$**

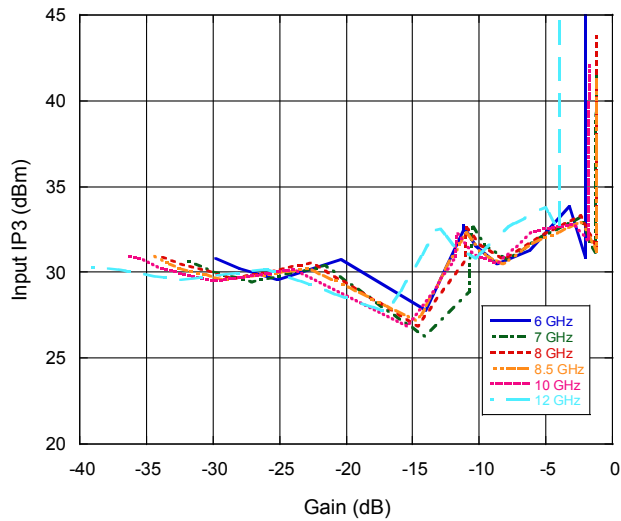

**Input IP3 vs. Attenuation, SCL  $P_{IN} = 12\text{ dBm}$**

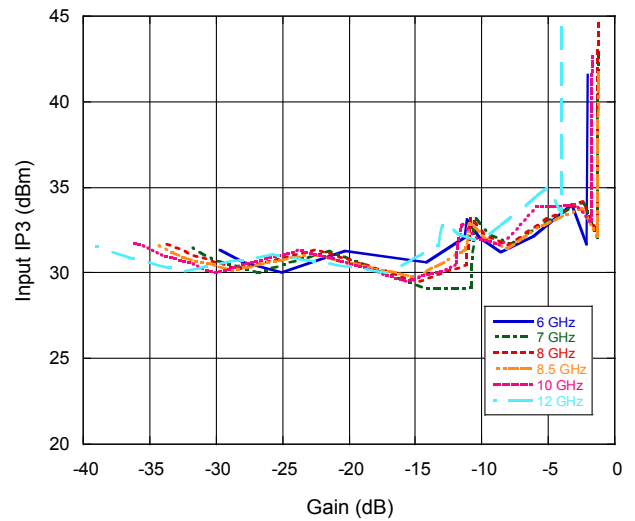

**Lead-Free 3 mm 16-Lead PQFN<sup>†</sup>**

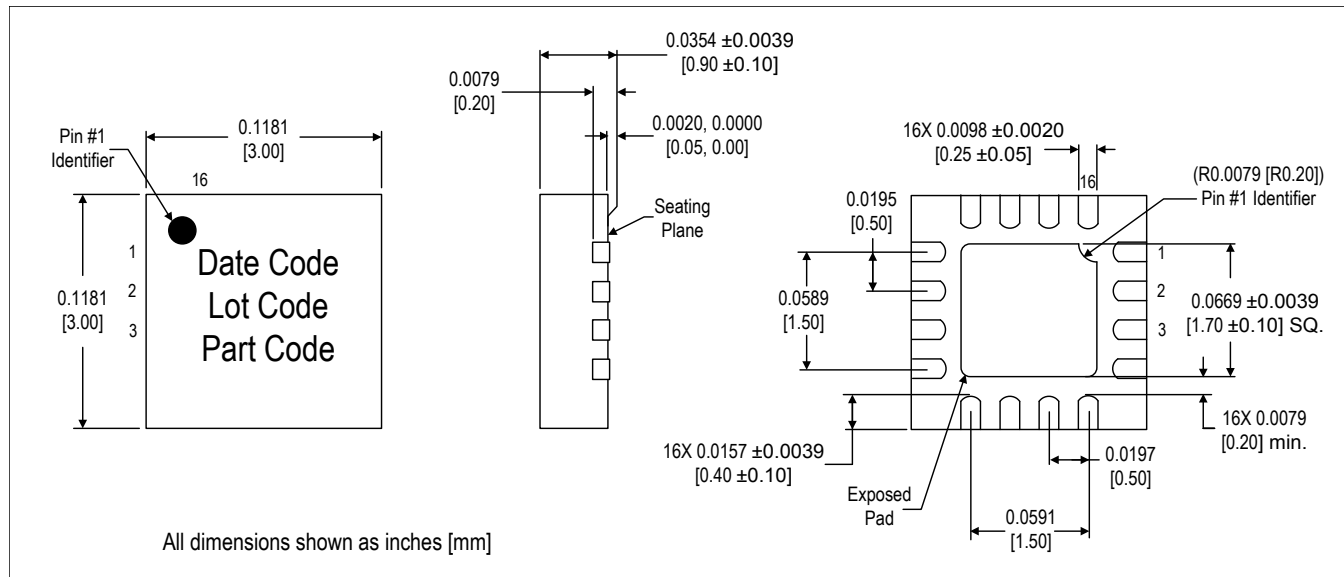

<sup>†</sup> Reference Application Note S2083 for lead-free solder reflow recommendations.  
Meets JEDEC moisture sensitivity level 1 requirements.  
Plating is NiPdAuAg.

MACOM Technology Solutions Inc. All rights reserved.

Information in this document is provided in connection with MACOM Technology Solutions Inc ("MACOM") products. These materials are provided by MACOM as a service to its customers and may be used for informational purposes only. Except as provided in MACOM's Terms and Conditions of Sale for such products or in any separate agreement related to this document, MACOM assumes no liability whatsoever. MACOM assumes no responsibility for errors or omissions in these materials. MACOM may make changes to specifications and product descriptions at any time, without notice. MACOM makes no commitment to update the information and shall have no responsibility whatsoever for conflicts or incompatibilities arising from future changes to its specifications and product descriptions. No license, express or implied, by estoppel or otherwise, to any intellectual property rights is granted by this document.

THESE MATERIALS ARE PROVIDED "AS IS" WITHOUT WARRANTY OF ANY KIND, EITHER EXPRESS OR IMPLIED, RELATING TO SALE AND/OR USE OF MACOM PRODUCTS INCLUDING LIABILITY OR WARRANTIES RELATING TO FITNESS FOR A PARTICULAR PURPOSE, CONSEQUENTIAL OR INCIDENTAL DAMAGES, MERCHANTABILITY, OR INFRINGEMENT OF ANY PATENT, COPYRIGHT OR OTHER INTELLECTUAL PROPERTY RIGHT. MACOM FURTHER DOES NOT WARRANT THE ACCURACY OR COMPLETENESS OF THE INFORMATION, TEXT, GRAPHICS OR OTHER ITEMS CONTAINED WITHIN THESE MATERIALS. MACOM SHALL NOT BE LIABLE FOR ANY SPECIAL, INDIRECT, INCIDENTAL, OR CONSEQUENTIAL DAMAGES, INCLUDING WITHOUT LIMITATION, LOST REVENUES OR LOST PROFITS, WHICH MAY RESULT FROM THE USE OF THESE MATERIALS.

MACOM products are not intended for use in medical, lifesaving or life sustaining applications. MACOM customers using or selling MACOM products for use in such applications do so at their own risk and agree to fully indemnify MACOM for any damages resulting from such improper use or sale.