

Power Amplifier, 0.25 W DC - 27 GHz



MAAP-011324-DIE

Rev. V2

Features

- High Gain: 18 dB
- P1dB: 25 dBm
- P3dB: 26 dBm
- Output IP3: 35 dBm
- Bias Voltage: $V_{DD} = 8\text{ V}$
- Bias Current: $I_{DSQ} = 220\text{ mA}$
- 50 Ω Matched Input / Output
- Temperature Compensated Output Power Detector
- Die Size: 2800 x 1300 x 100 μm
- RoHS* Compliant

Applications

- Test & Measurement
- EW
- ECM
- Radar

Description

The MAAP-011324-DIE is a 0.25 W distributed power amplifier offered in bare die form. The power amplifier operates from DC to 27 GHz and provides 18 dB of linear gain and 26 dBm of output power at 3-dB compression. The device is fully matched across the band and includes a temperature compensated output power detector.

The MAAP-011324-DIE can be used as a power amplifier stage or as a driver stage in higher power applications.

This product is fabricated using a GaAs pHEMT process which features full passivation for enhanced reliability.

Functional Schematic

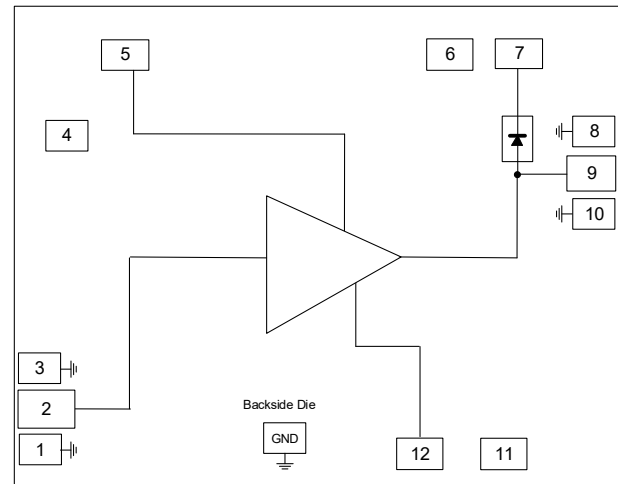

Pin Configuration³

| Pin # | Pin Name | Description |
|----------|------------------------------------|---------------------------|
| 1,3,8,10 | GND | Ground |
| 2 | RF _{IN} | RF Input |
| 4,6,11 | Not Used | Not Used |
| 5 | V _{D_AUX} | V _{D_Auxiliary} |
| 7 | DET | Power Detector |
| 9 | RF _{OUT} /V _{DD} | RF Output / Drain Voltage |
| 12 | V _G | Gate Voltage |

3. Backside of die must be connected to RF, DC and thermal ground.

Ordering Information^{1,2}

| Part Number | Package |
|--------------------|-----------------|
| MAAP-011324-DIE | DIE in Gel Pack |
| MAAP-011324-DIESMB | Sample Board |

1. Reference Application Note M513 for reel size information.
2. Sample Board is DIE EVAL. Module.

* Restrictions on Hazardous Substances, compliant to current RoHS EU directive.

1

MACOM Technology Solutions Inc. (MACOM) and its affiliates reserve the right to make changes to the product(s) or information contained herein without notice. Visit www.macom.com for additional data sheets and product information.

For further information and support please visit:
<https://www.macom.com/support>

DC-0026171

Power Amplifier, 0.25 W DC - 27 GHz



MAAP-011324-DIE

Rev. V2

Electrical Specifications (Measure on Bare DIE):

$T_A = +25^\circ\text{C}$, $V_{DD} = 8\text{ V}$, $I_{DSQ} = 220\text{ mA}$, $Z_0 = 50\ \Omega$

| Parameter | Test Conditions | Units | Min. | Typ. | Max. |
|--------------------------|--|-------|---------------------------|------------------------------|------|
| Gain | 2 GHz 12 GHz 22 GHz 27 GHz | dB | 17.0 17.0 17.0 — | 18.5 18.0 18.0 17.5 | — |
| P_{OUT} | $P_{IN} = +10\text{ dBm}$ 2 GHz 12 GHz 22 GHz 27 GHz | dBm | — | 27.5 26.5 24.5 21.0 | — |
| P1dB | 2 GHz 12 GHz 22 GHz 27 GHz | dBm | 24.0 23.0 20.5 — | 26.0 25.0 22.0 20.5 | — |
| OIP3 | $P_{OUT} = +14\text{ dBm/tone}$ (10 MHz Tone Spacing) 2 GHz 12 GHz 22 GHz 27 GHz | dBm | — | 38.0 34.5 33.5 32.5 | — |
| PAE | $P_{IN} = +10\text{ dBm}$ 2 GHz 12 GHz 22 GHz 27 GHz | % | — | 29 24 14 6.5 | — |
| Vdet | 10 dBm P_{OUT} , 7 GHz 25 dBm P_{OUT} , 7 GHz | mV | — | 150 350 | — |
| Input Return Loss | $P_{IN} = -10\text{ dBm}$ | dB | — | 15 | — |
| Output Return Loss | $P_{IN} = -10\text{ dBm}$ | dB | — | 15 | — |
| I_{DD} (with RF drive) | $P_{IN} = +10\text{ dBm}$ | mA | — | 250 | — |
| I_G | — | mA | — | 4 | — |

Maximum Operating Ratings

| Parameter | Rating |
|-------------------------------------|----------------|
| Input Power | 13 dBm |
| Junction Temperature ^{4,5} | +150°C |
| Operating Temperature | -40°C to +85°C |

- Operating at nominal conditions with junction temperature $\leq +150^\circ\text{C}$ will ensure MTTF $> 1 \times 10^6$ hours.
- Junction Temperature (T_J) = $T_C + \Theta_{JC} * ((V * I) - (P_{OUT} - P_{IN}))$
Typical thermal resistance (Θ_{JC}) = 10.1 °C/W.
a) For $T_C = +25^\circ\text{C}$,
 $T_J = +41.7^\circ\text{C}$ @ 8 V, 235 mA, $P_{OUT} = 23.6\text{ dBm}$, $P_{IN} = 8\text{ dBm}$
b) For $T_C = +85^\circ\text{C}$,
 $T_J = +102.1^\circ\text{C}$ @ 8 V, 235 mA, $P_{OUT} = 22.9\text{ dBm}$, $P_{IN} = 8\text{ dBm}$

Absolute Maximum Ratings^{6,7,8}

| Parameter | Absolute Maximum |
|-----------------------------------|------------------|
| Input Power | 25 dBm |
| Drain Voltage | +10 V |
| Gate Voltage | -5 to 0 V |
| Junction Temperature ⁹ | +175°C |
| Storage Temperature | -65°C to +125°C |

- Exceeding any one or combination of these limits may cause permanent damage to this device.
- MACOM does not recommend sustained operation near these survivability limits.
- Junction temperature directly effects device MTTF. Junction temperature should be kept as low as possible to maximize lifetime.

Application Schematic

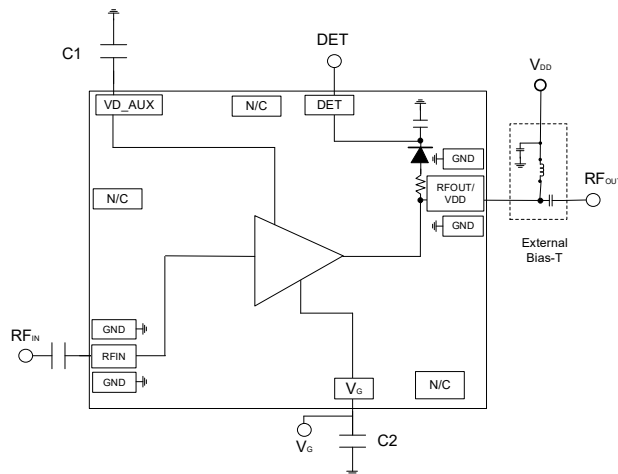

Operating the MAAP-011324-DIE

Turn-on

1. Apply V_{G1} (-4.5 V).
2. Increase V_{DD} to 8 V.
3. Set I_{DSQ} by adjusting V_G more positive (typically -0.53 V for $I_{DSQ} = 220$ mA).
4. Apply RF_{IN} signal.

Turn-off

1. Remove RF_{IN} signal.
2. Decrease V_G to -4.5 V.
3. Decrease V_{DD} to 0 V.

Bill of Materials^{9,10,11}

| Part | Value | Size | Comment |
|--------|-----------|------|---------|
| C1, C2 | 1 μ F | 0402 | bypass |

9. C1 & C2 are required for operation below 1 GHz.
10. High power external bias tee was used for measurements.
11. External DC block was used on input.

Biasing Conditions

Recommended biasing conditions are $V_{DD} = 8$ V, $I_{DSQ} = 220$ mA (controlled with V_G).

By-pass capacitor C1 for the auxiliary pad is for a low frequency operation extension (below 1 GHz). This provides wide band performance of 100 kHz - 27 GHz (depending on the bandwidth of the bias tees).

To bias the drain:

1. The required V_{DD} is applied at RF_{OUT}/V_{DD} through the bias tee.

There are 2 possible methods to bias the gate:

1. V_G is applied using the V_G pad (pin 12) and set using to provide the required current bias (I_{DSQ}). No external bias tee is required at the RF input but an external DC block is required.
2. V_G is applied at the RF input (pin 2) through an external bias tee on the RF input line and set to provide the required current bias (I_{DSQ}).

Handling Procedures

Please observe the following precautions to avoid damage:

Static Sensitivity

These electronic devices are sensitive to electrostatic discharge (ESD) and can be damaged by static electricity. Proper ESD control techniques should be used when handling these HBM Class 1B devices.

Recommended PCB Information

RF input and output are 50 Ω transmission lines. Single layer 8 mil Rogers RO4008 with 1/2 oz. Cu. Use copper filled vias under ground paddle.

Grounding

It is recommended that the total ground (common mode) inductance not exceed 0.03 nH (30 pH). This is equivalent to placing at least four 8-mil (200- μ m) diameter vias under the device, assuming an 8-mil (200- μ m) thick RF layer to ground.

PCB Layout:

RF input and output traces on 901-10101B board are cut such that die can fit between them with out shorting them to ground.

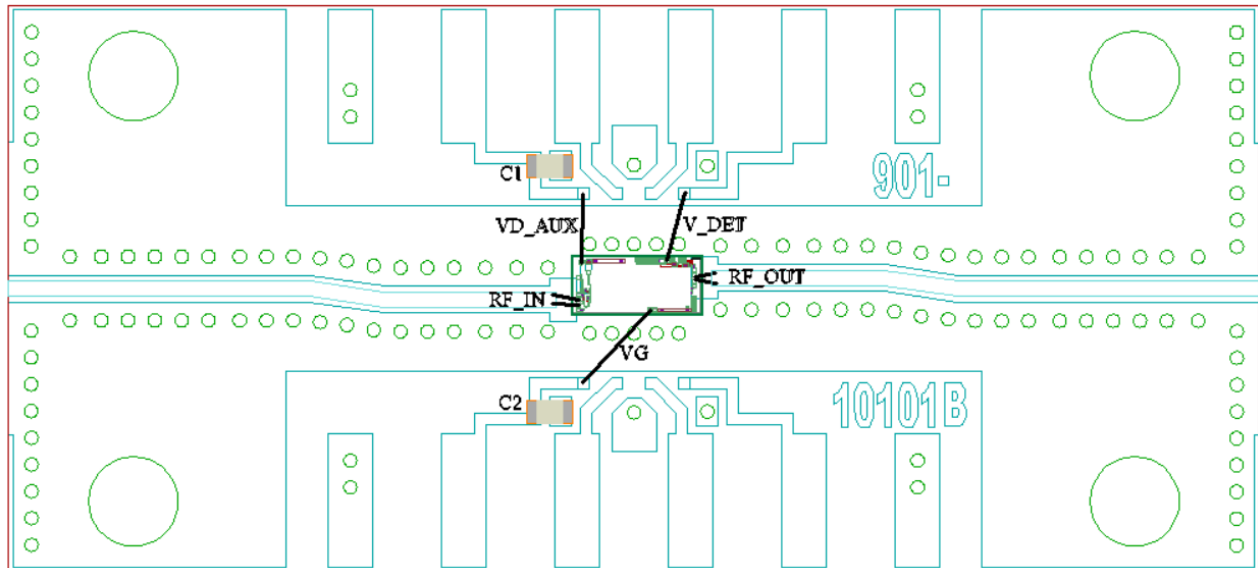

Close Up:

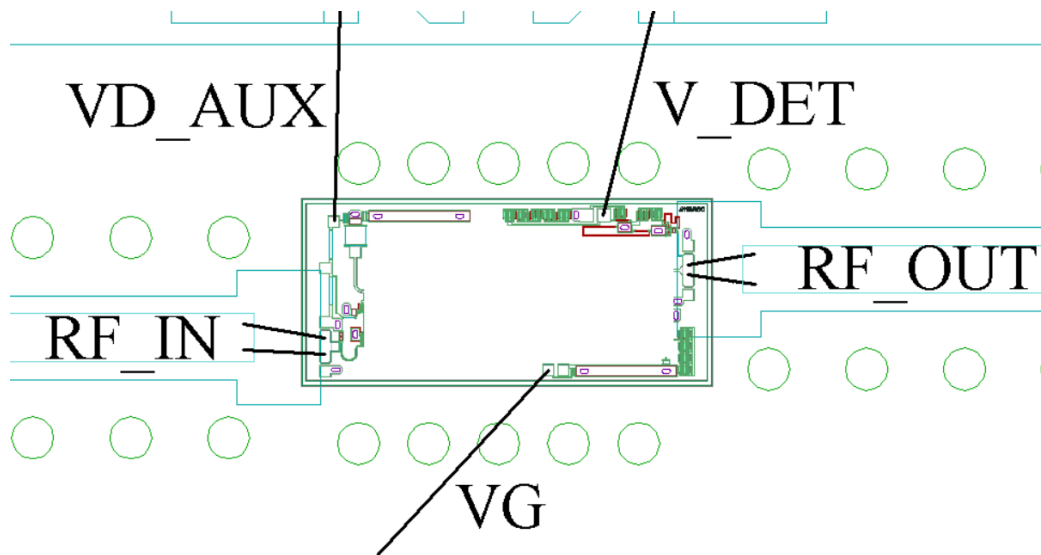

Power Amplifier, 0.25 W DC - 27 GHz



MAAP-011324-DIE

Rev. V2

Typical Performance Curves (Measurement includes Wirebond):

$V_{DD} = 8\text{ V}$, $I_{DSQ} = 220\text{ mA}$, $V_G = -0.53\text{ V}$ typical

S Parameters

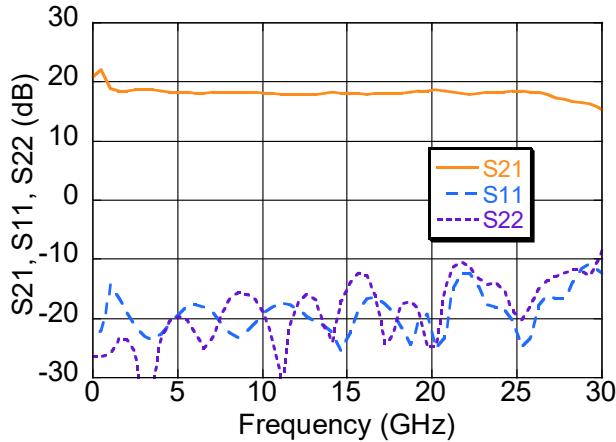

Gain

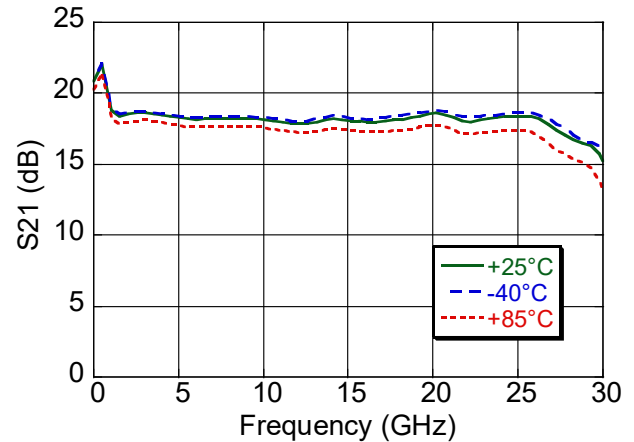

Input Return Loss

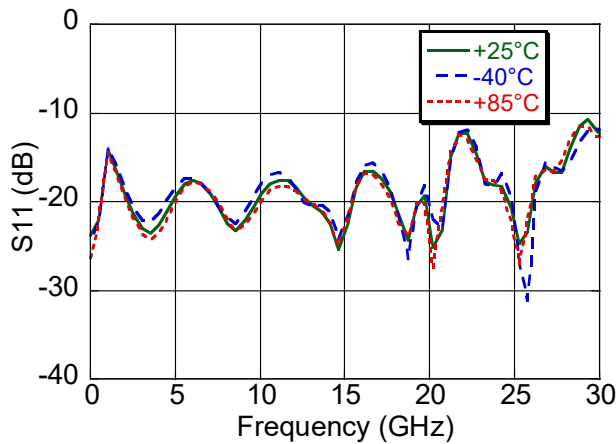

Output Return Loss

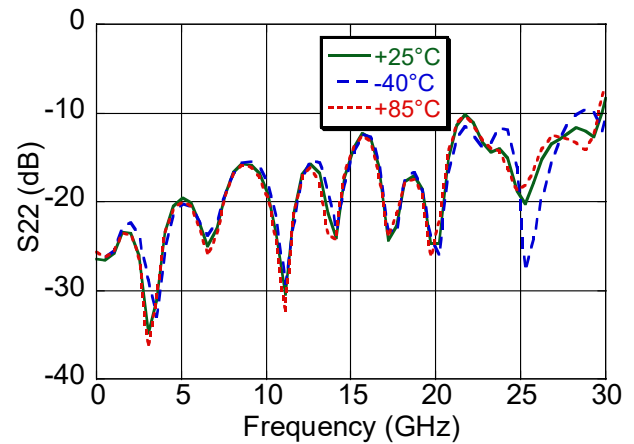

Isolation

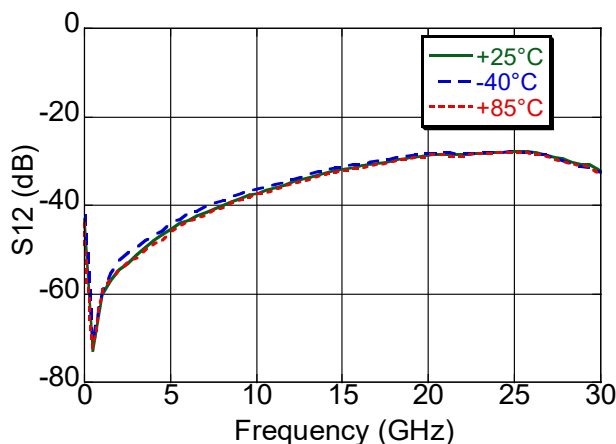

Power Amplifier, 0.25 W DC - 27 GHz



MAAP-011324-DIE

Rev. V2

Typical Performance Curves (Measurement includes Wirebond):

$V_{DD} = 8\text{ V}$, $I_{DSQ} = 220\text{ mA}$, $V_G = -0.53\text{ V}$ typical

Noise Figure over Temperature

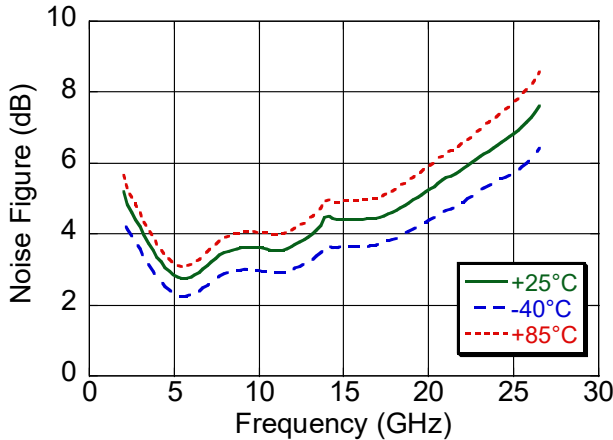

P1dB over Temperature

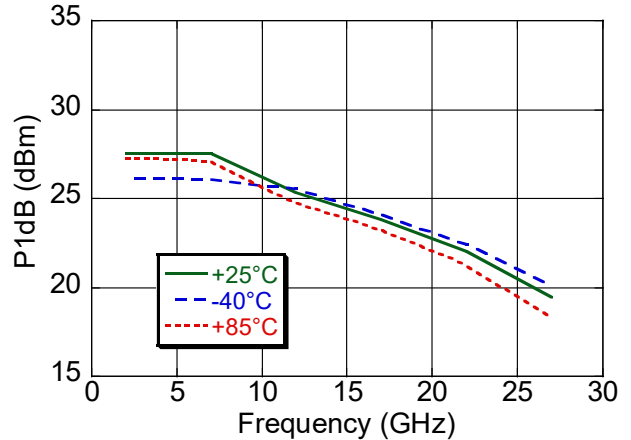

P_{SAT} over Temperature

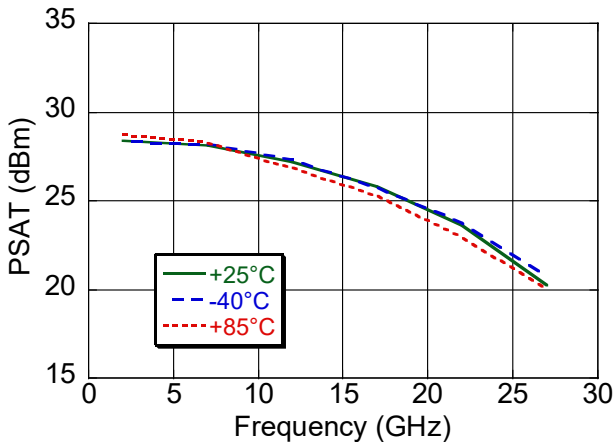

Output IP3 over Temperature @ 14 dBm per tone

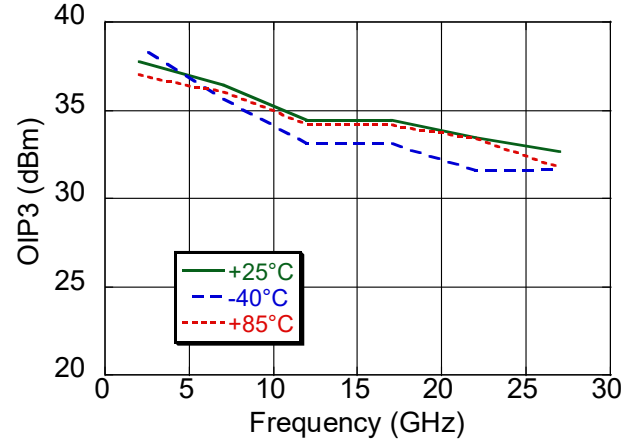

2nd Harmonic

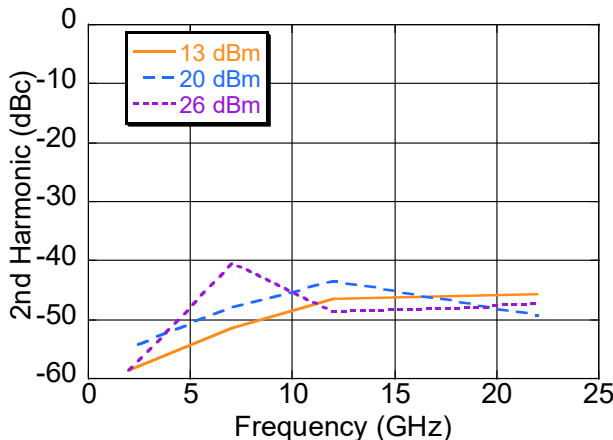

Detected Voltage

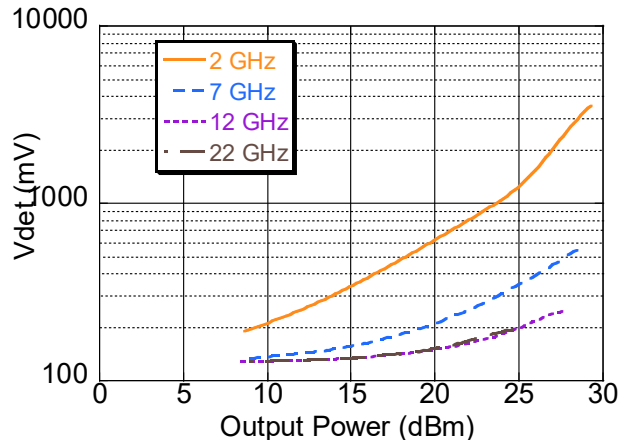

Power Amplifier, 0.25 W DC - 27 GHz



MAAP-011324-DIE

Rev. V2

Typical Performance Curves (Measurement includes Wirebond):

$V_{DD} = 8\text{ V}$, $I_{DSQ} = 220\text{ mA}$, $V_G = -0.53\text{ V}$ typical

Power Compression @ 2 GHz

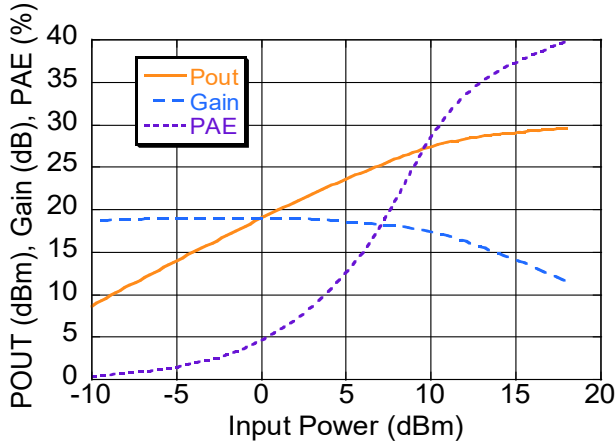

Power Compression @ 12 GHz

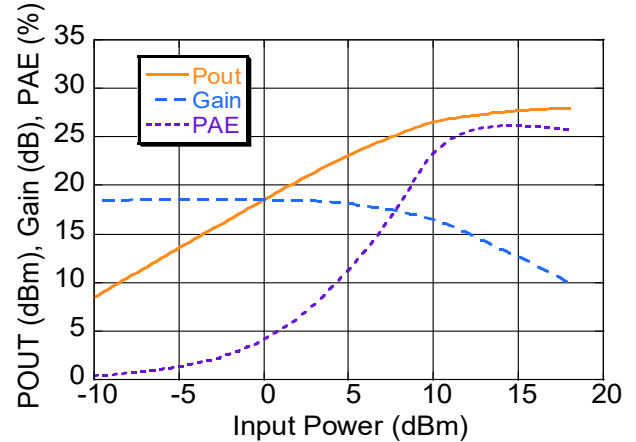

Power Compression @ 22 GHz

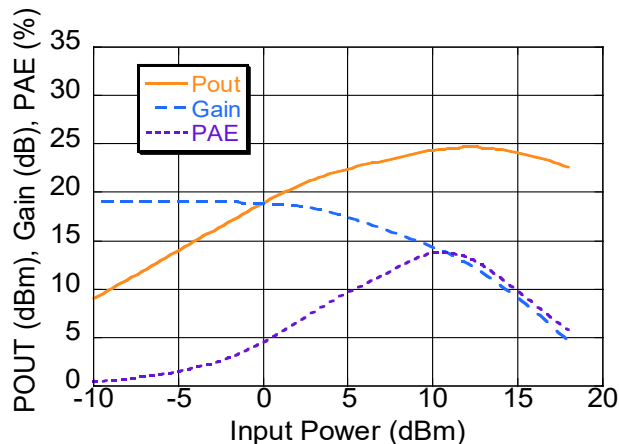

Power Compression @ 27 GHz

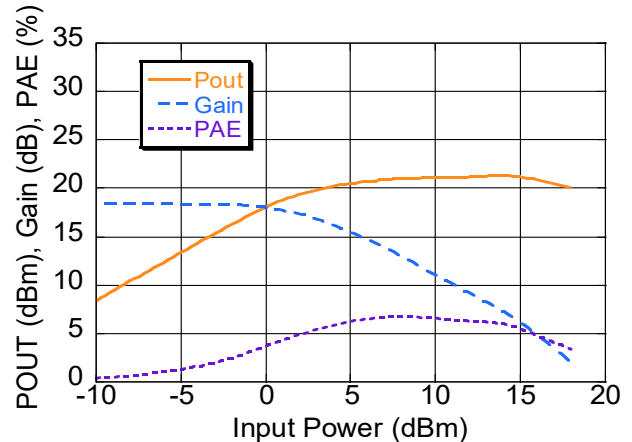

Current

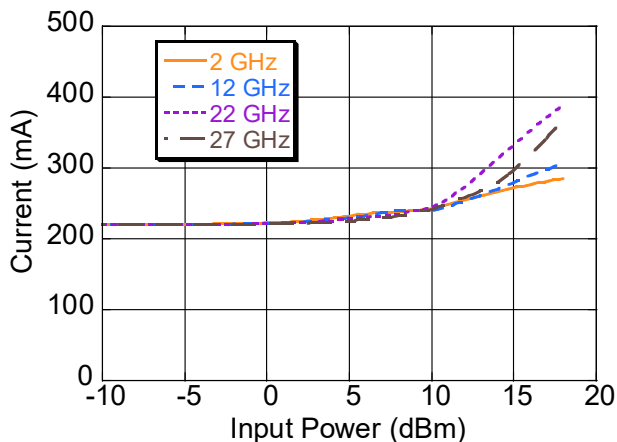

Test Board Loss including Connector

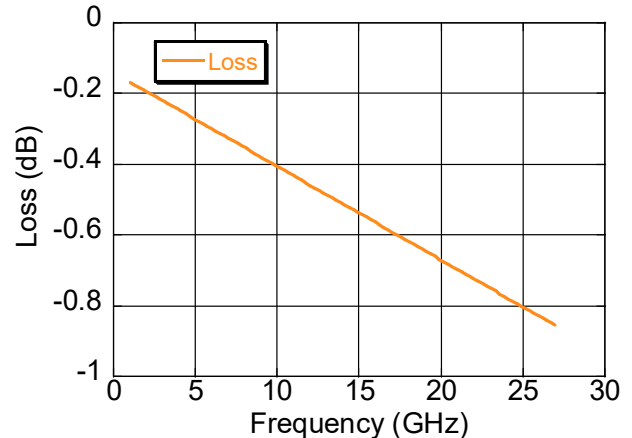

Die Dimensions^{12,13,14,15}

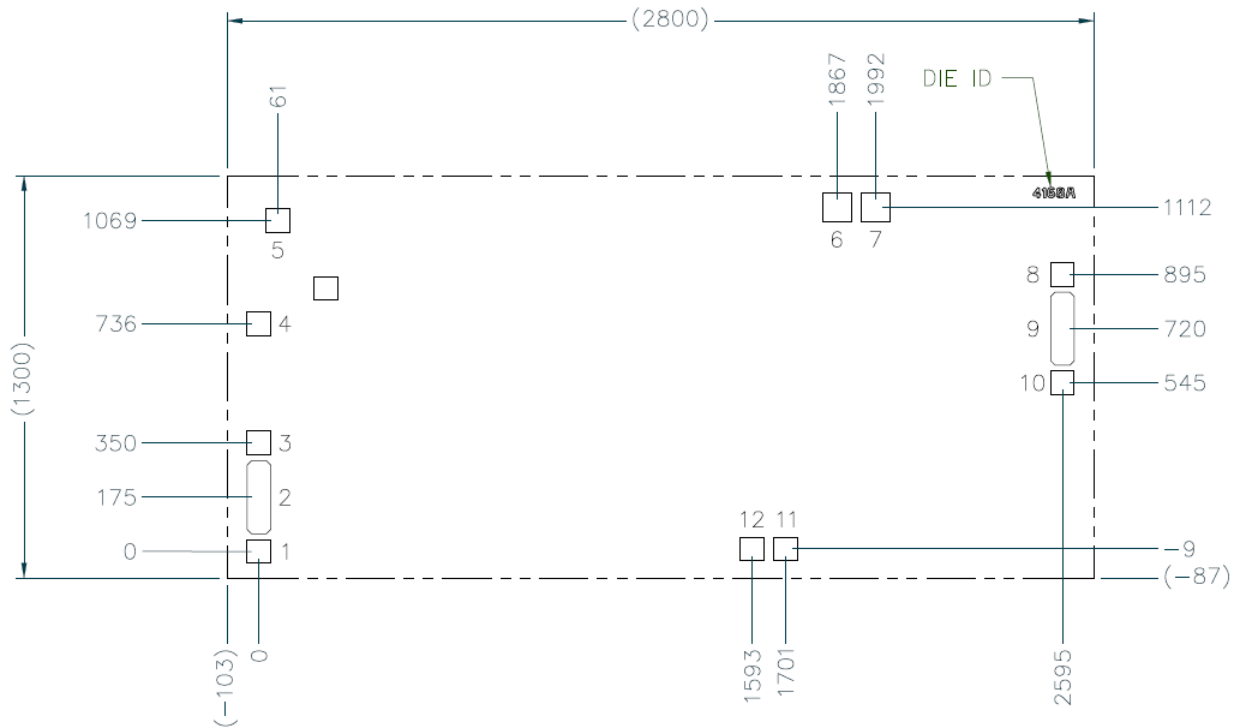

- 12. All units in μm, unless otherwise noted, with a tolerance of ± 5 μm.
- 13. Die thickness is 100 ± 10 μm.
- 14. Die size reflects un-cut dimensions. Laser kerf reduces die size by ~ 25 μm each dimension.
- 15. Bond Pad / Backside Metallization : Gold
- 16. The un-numbered bondpad near pads 4 and 5 is for DC probe test only.

Bond Pad Dimensions (μm)

| Pad | X | Y |
|----------------------------|----|-----|
| 1,3,4,5,6,7, 8,10,11,12 | 76 | 76 |
| 2,9 | 76 | 236 |

MACOM Technology Solutions Inc. ("MACOM"). All rights reserved.

These materials are provided in connection with MACOM's products as a service to its customers and may be used for informational purposes only. Except as provided in its Terms and Conditions of Sale or any separate agreement, MACOM assumes no liability or responsibility whatsoever, including for (i) errors or omissions in these materials; (ii) failure to update these materials; or (iii) conflicts or incompatibilities arising from future changes to specifications and product descriptions, which MACOM may make at any time, without notice. These materials grant no license, express or implied, to any intellectual property rights.

THESE MATERIALS ARE PROVIDED "AS IS" WITH NO WARRANTY OR LIABILITY, EXPRESS OR IMPLIED, RELATING TO SALE AND/OR USE OF MACOM PRODUCTS INCLUDING FITNESS FOR A PARTICULAR PURPOSE, MERCHANTABILITY, INFRINGEMENT OF INTELLECTUAL PROPERTY RIGHT, ACCURACY OR COMPLETENESS, OR SPECIAL, INDIRECT, INCIDENTAL, OR CONSEQUENTIAL DAMAGES WHICH MAY RESULT FROM USE OF THESE MATERIALS.

MACOM products are not intended for use in medical, lifesaving or life sustaining applications. MACOM customers using or selling MACOM products for use in such applications do so at their own risk and agree to fully indemnify MACOM for any damages resulting from such improper use or sale.