

### Features

- Gain: 14 dB @ 6 V, 30 GHz
- P1dB: 18 dBm @ 6 V, 30 GHz
- P3dB: 20 dBm @ 6 V, 30 GHz
- Integrated Power Detector
- Gain control with only positive bias voltages
- 50  $\Omega$  Input and Output Match
- Bias Voltage:  $V_{DD} = 4 - 6$  V
- Bias Current:  $I_{DSQ} = 125 - 150$  mA
- Die size: 2.1 mm x 1.05 mm
- RoHS\* Compliant

### Description

MAAM-011238-DIE is an easy-to-use, wideband amplifier that operates from 100 kHz to 67.5 GHz. The amplifier provides 14 dB gain, 4.5 dB noise figure and 33 dBm of P3dB output power @ 30 GHz. It is matched to 50  $\Omega$  with typical return loss better than 12 dB. The amplifier requires only positive bias voltages and would typically be operated at 6V and 135 mA.

MAAM-011238-DIE is suitable for a wide range of applications in instrumentation and communication systems.

### Ordering Information

Part Number	Package
MAAM-011238-DIE	Die in Gel Pak

### Functional Schematic<sup>1</sup>

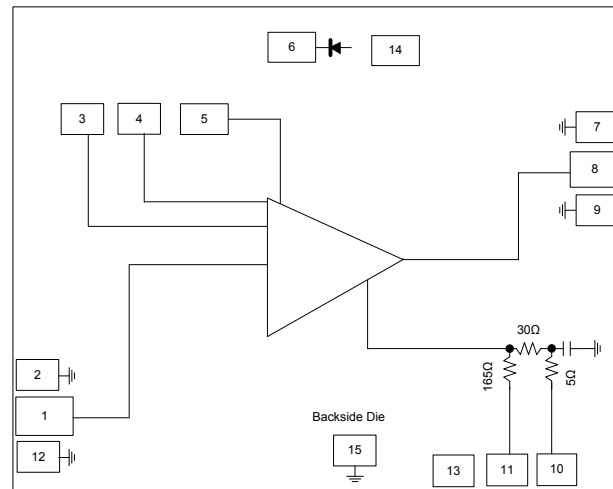

### Pad Configuration<sup>2</sup>

Pin #	Pin Name	Description
1	RF <sub>IN</sub>	RF Input / Gate Voltage
2, 7, 9, 11, 12, 15	GND	DC & RF Ground to Backside Via
3	V <sub>G2</sub>	Gate Voltage 2
4	V <sub>DD</sub>	Drain Voltage
5	V <sub>AUX</sub>	Auxiliary Drain Voltage
6	V <sub>DET</sub>	Detector Voltage
8	RF <sub>OUT</sub>	RF Output / Drain Voltage
10	V <sub>G1</sub>	Gate Voltage 1
13, 14	NC	Not Connected

1. Image not to scale.
2. The backside of the die must be connected to RF, DC and thermal ground.

\* Restrictions on Hazardous Substances, compliant to current RoHS EU directive.

## Wideband Distributed Amplifier 100 kHz - 67.5 GHz

Rev. V1

Electrical Specifications:  $T_C = +25^\circ\text{C}$ ,  $V_D = 6\text{ V}$ ,  $Z_0 = 50\ \Omega$

Parameter	Test Conditions	Units	Min.	Typ.	Max.
Gain	0.0001 - 10 GHz	dB	14	15.9	—
	10 - 20 GHz		13.8	15.5	
	20 - 30 GHz		13.3	15.0	
	30 - 40 GHz		12.5	14.0	
	40 - 50 GHz		11.5	13.0	
	50 - 60 GHz		—	11.5	
	60 - 67.5 GHz		—	7.0	
Noise Figure	2.8 - 10 GHz	dB	—	6.0	—
	10 - 20 GHz			4.1	
	20 - 30 GHz			4.7	
	30 - 40 GHz			6.0	
	40 - 50 GHz			9.0	
Input Return Loss	0.0001 - 10 GHz	dB	—	18.0	—
	10 - 20 GHz			17.0	
	20 - 30 GHz			17.0	
	30 - 40 GHz			16.6	
	40 - 67.5 GHz			15.0	
Output Return Loss	0.0001 - 10 GHz	dB	—	17.0	—
	10 - 20 GHz			15.0	
	20 - 30 GHz			13.0	
	30 - 40 GHz			13.5	
	40 - 67.5 GHz			12.0	
P1dB	40 GHz	dBm	15	17.6	—
P3dB	0.0001 - 10 GHz	dBm	—	22.0	—
	10 - 20 GHz			21.0	
	20 - 30 GHz			20.0	
	30 - 40 GHz			19.0	
	40 - 50 GHz			18.0	
	50 - 60 GHz			16.0	
	60 - 67.5 GHz			14.0	
Output IP3	0.0001 - 10 GHz	dBm	—	29.0	—
	10 - 20 GHz			28.0	
	20 - 30 GHz			27.0	
	30 - 40 GHz			26.5	
	40 - 50 GHz			25.0	
	50 - 60 GHz			22.0	
	60 - 67.5 GHz			16.0	
Drain Current	Quiescent Bias	mA	—	135	—

## Wideband Distributed Amplifier 100 kHz - 67.5 GHz

Rev. V1

Electrical Specifications:  $T_C = +25^\circ\text{C}$ ,  $V_D = 5\text{ V}$ ,  $Z_0 = 50\ \Omega$

Parameter	Test Conditions	Units	Min.	Typ.	Max.
Gain	0.0001 - 10 GHz	dB	—	16.5	—
	10 - 20 GHz			16.0	
	20 - 30 GHz			16.0	
	30 - 40 GHz			16.0	
	40 - 50 GHz			16.0	
	50 - 60 GHz			15.0	
	60 - 67.5 GHz			12.0	
Noise Figure	2.8 - 10 GHz	dB	—	6.0	—
	10 - 20 GHz			4.1	
	20 - 30 GHz			4.7	
	30 - 40 GHz			6.0	
	40 - 50 GHz			9.0	
Input Return Loss	0.0001 - 10 GHz	dB	—	18.0	—
	10 - 20 GHz			17.0	
	20 - 30 GHz			17.0	
	30 - 40 GHz			16.6	
	40 - 67.5 GHz			15.0	
Output Return Loss	0.0001 - 10 GHz	dB	—	17.0	—
	10 - 20 GHz			15.0	
	20 - 30 GHz			13.0	
	30 - 40 GHz			13.5	
	40 - 67.5 GHz			12.0	
P1dB	0.0001 - 10 GHz	dBm	—	18.0	—
	10 - 20 GHz			17.6	
	20 - 30 GHz			17.0	
	30 - 40 GHz			17.5	
	40 - 50 GHz			15.5	
	50 - 60 GHz			15.0	
	60 - 67.5 GHz			14.0	
P3dB	0.0001 - 10 GHz	dBm	—	21.5	—
	10 - 20 GHz			21.0	
	20 - 30 GHz			19.5	
	30 - 40 GHz			18.5	
	40 - 50 GHz			17.5	
	50 - 60 GHz			17.0	
	60 - 67.5 GHz			16.0	
Output IP3	0.0001 - 10 GHz	dBm	—	25.0	—
	10 - 20 GHz			26.0	
	20 - 30 GHz			25.5	
	30 - 40 GHz			25.5	
	40 - 50 GHz			24.0	
	50 - 60 GHz			22.5	
	60 - 67.5 GHz			17.0	
Drain Current	Quiescent bias	mA	—	150	—

## Wideband Distributed Amplifier 100 kHz - 67.5 GHz

Rev. V1

### Operating Conditions

One of the recommended biasing conditions is  $V_{DD} = 6\text{ V}$ ,  $I_{DSQ} = 135\text{ mA}$ . (controlled with  $V_{G1}$ ).  $I_{DSQ}$  is set by adjusting  $V_{G1}$  after correctly setting  $V_{DD}$ . (Refer to turn on sequence.)

There are two possible bias methods:

1. The use of an external DC block on the input and a bias tee. The required  $V_{DD}$  is applied at  $RF_{OUT}/V_{DD}$  through the bias tee and  $V_G$  is set to provide the required current bias ( $I_{DSQ}$ ). This provides wide band performance of 40 MHz - 67.5 GHz. (depending on the bandwidth of the bias tee)
2. The direct application of drain voltage to  $V_{DD}$  using a wideband conical. No external bias tee is required. However DC blocking is required on both the  $RF_{IN}$  and  $RF_{OUT}$ . Using this method provides for an operational frequency of 40 MHz - 67.5 GHz.

For low frequency extension, the addition of 2 bypass capacitors on  $V_{G1}$  and  $VAUX$  of 1200 pF and 10  $\mu\text{F}$  will improve the frequency of operation down to 100 kHz.. These capacitors should be positioned as close to the device as possible.

Dynamic gain control is available when operating in the linear gain region through the application of 0 to 1.6 V to  $V_{G2}$ .

The evaluation board is configured with bias option 1. Bypass capacitors on  $V_{G1}$  and  $VAUX$  are also included for operation down to 100 kHz. Data in this datasheet was measured using option 1.

### Operating the MAAM-011238-DIE

#### Turn-on

1. Apply  $V_{G1}$  to 0 V.
2. Apply  $V_{DD}$  to 6 V.
3. Set  $I_{DSQ}$  by adjusting  $V_{G1}$  more positive. (typically 3 V for  $I_{DSQ} = 135\text{ mA}$ ).
4. Apply  $RF_{IN}$  signal.

#### Turn-off

1. Remove  $RF_{IN}$  signal.
2. Decrease  $V_{G1}$  to 0 V.
3. Decrease  $V_{DD}$  to 0 V.

### Application Schematic

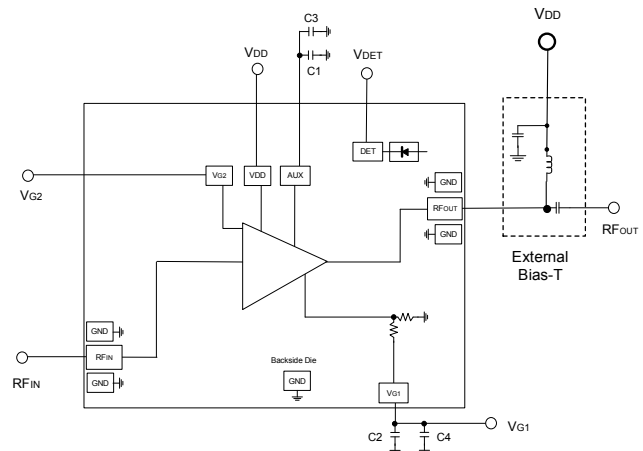

### Component List

Part	Value	Size	Part Number
C1, C2	1200 pF	25 mil	TECDIA SKT03C122V12A6
C3, C4	10 $\mu\text{F}$	0603	any

### Absolute Maximum Ratings<sup>3,4</sup>

Parameter	Absolute Maximum
Input Power	16 dBm
Drain Supply Voltage	8 V
Junction Temperature <sup>5,6</sup>	+150°C
Operating Temperature	-40°C to +85°C
Storage Temperature	-65°C to +150°C

3. Exceeding any one or combination of these limits may cause permanent damage to this device.
4. MACOM does not recommend sustained operation near these survivability limits.
5. Operating at nominal conditions with  $T_J \leq +150^\circ\text{C}$  will ensure  $MTTF > 1 \times 10^6$  hours.
6. Junction Temperature ( $T_J$ ) =  $T_A + \theta_{JA} * ((V * I) - (P_{OUT} - P_{IN}))$   
Typical thermal resistance ( $\theta_{JA}$ ) = 22.1 °C/W.  
For  $T_A = +85^\circ\text{C}$ ,  
 $T_J = +103^\circ\text{C}$  at  $V = 6\text{ V}$ ,  $I = 0.135\text{ A}$

## Wideband Distributed Amplifier 100 kHz - 67.5 GHz

Rev. V1

Typical Performance Curves:  $V_D = 6\text{ V}$ ,  $T_A = +25^\circ\text{C}$

**Gain**

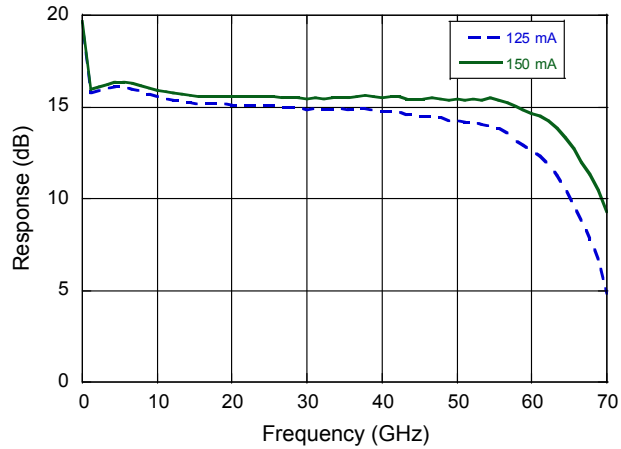

**Reverse Isolation**

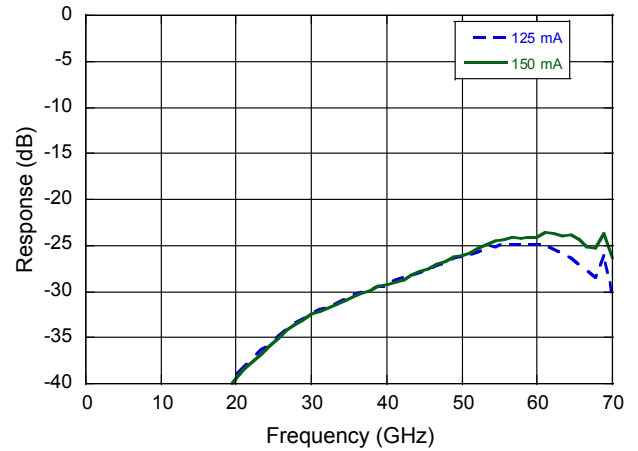

**Input Return Loss**

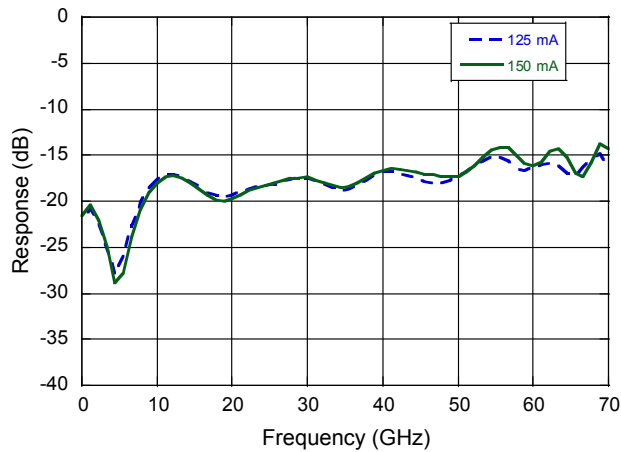

**Output Return Loss**

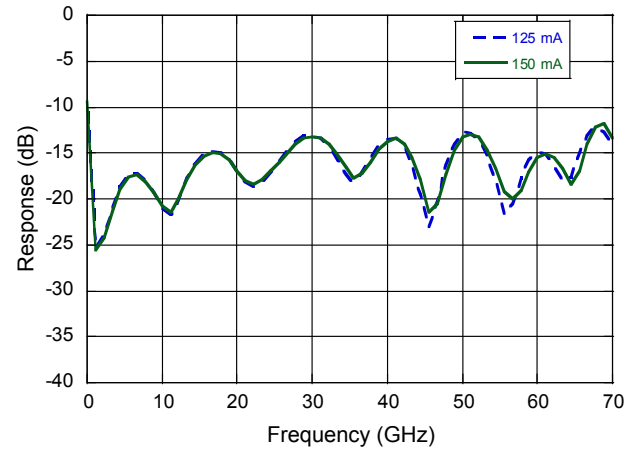

## Wideband Distributed Amplifier 100 kHz - 67.5 GHz

Rev. V1

Typical Performance Curves:  $V_D = 6\text{ V}$ ,  $I_D = 125\text{ mA}$

**Gain**

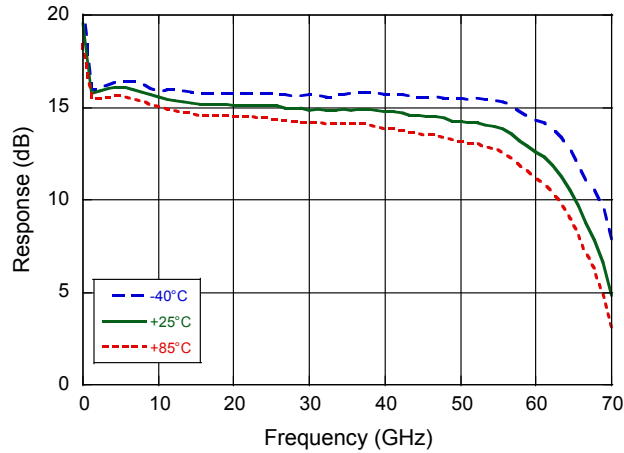

**Reverse Isolation**

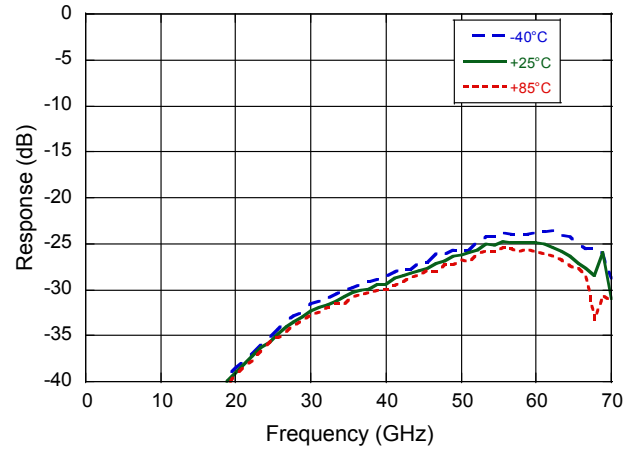

**Input Return Loss**

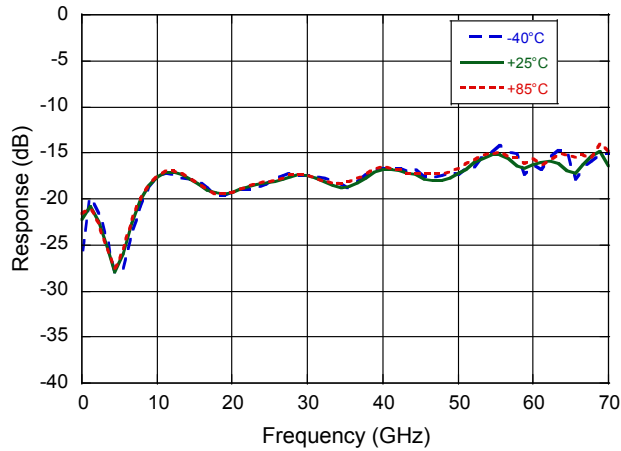

**Output Return Loss**

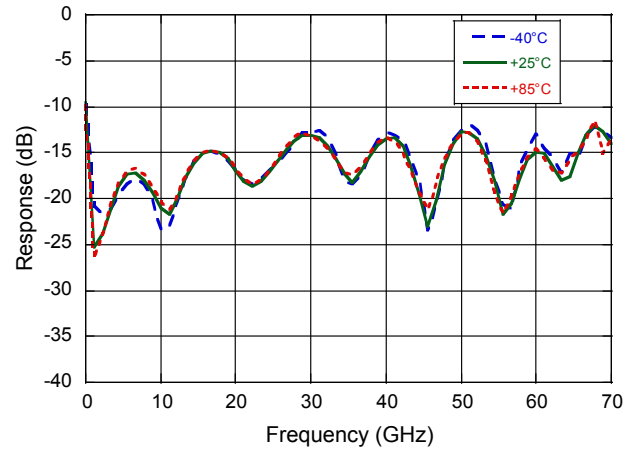

Typical Performance Curves:  $V_D = 6\text{ V}$ ,  $I_D = 135\text{ mA}$ ,  $T_A = +25^\circ\text{C}$

Output P1dB

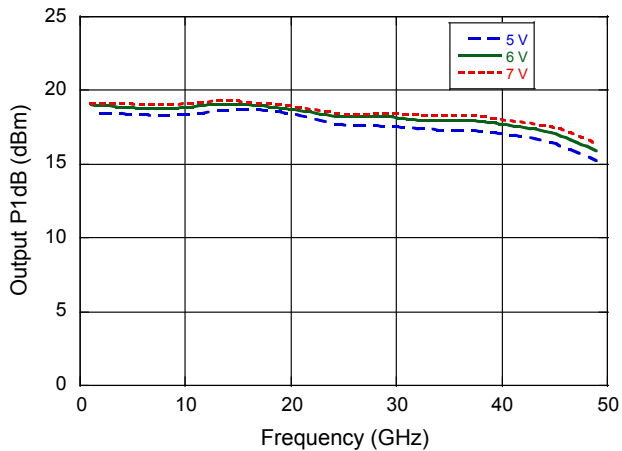

Output P3dB

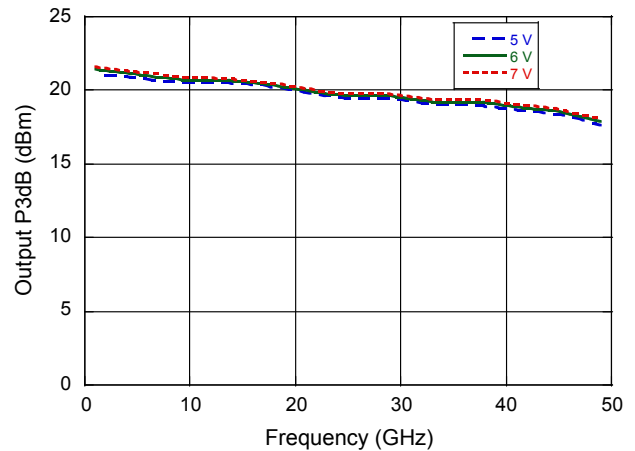

Noise Figure at  $T_A = 25^\circ\text{C}$

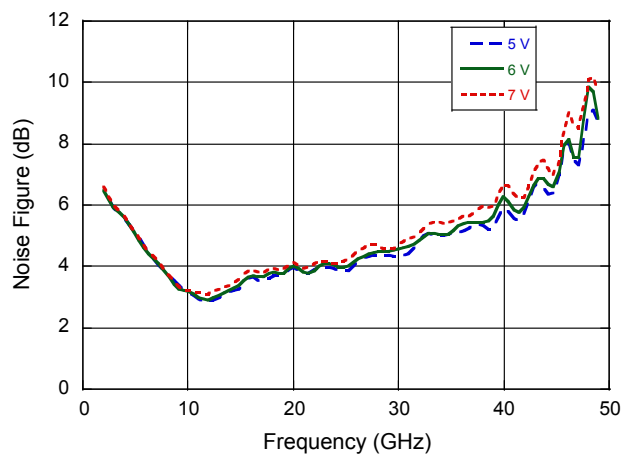

OIP3 at  $T_A = 25^\circ\text{C}$

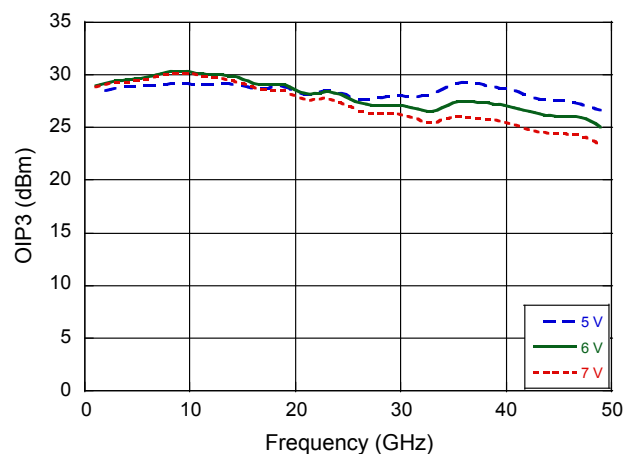

**Typical Performance Curves:  $V_D = 6\text{ V}$ ,  $I_D = 135\text{ mA}$**

**Output P1dB**

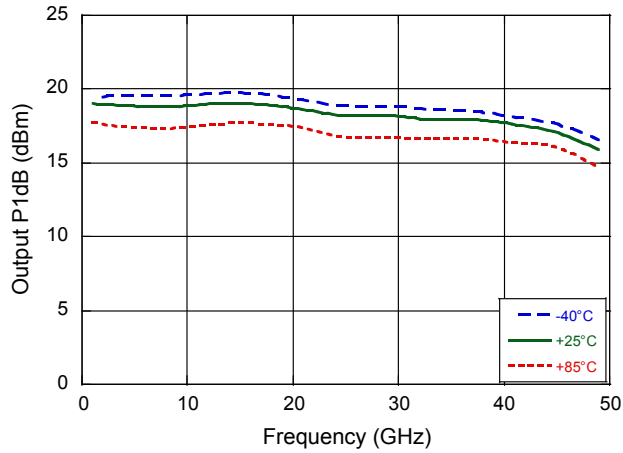

**Output P3dB**

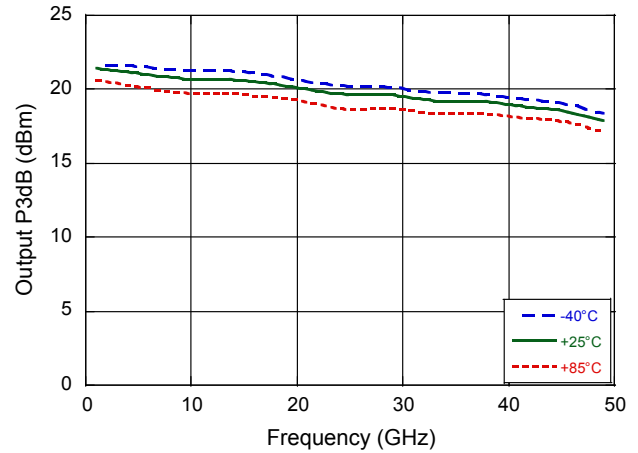

**Noise Figure**

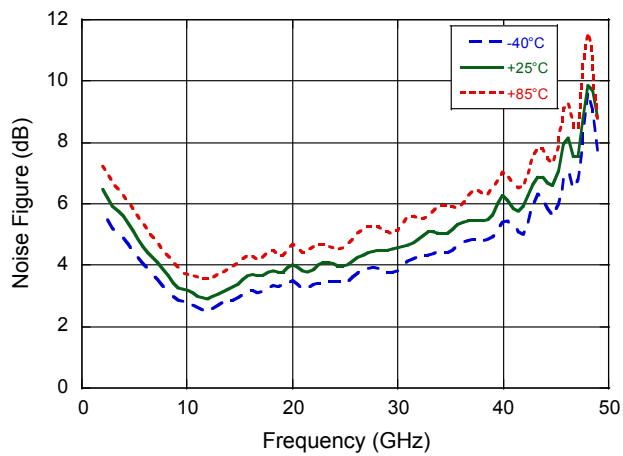

**OIP3**

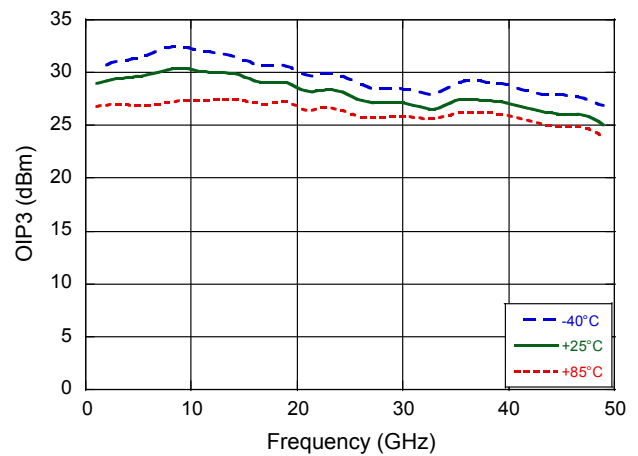



## Die Dimensions<sup>7,8</sup>

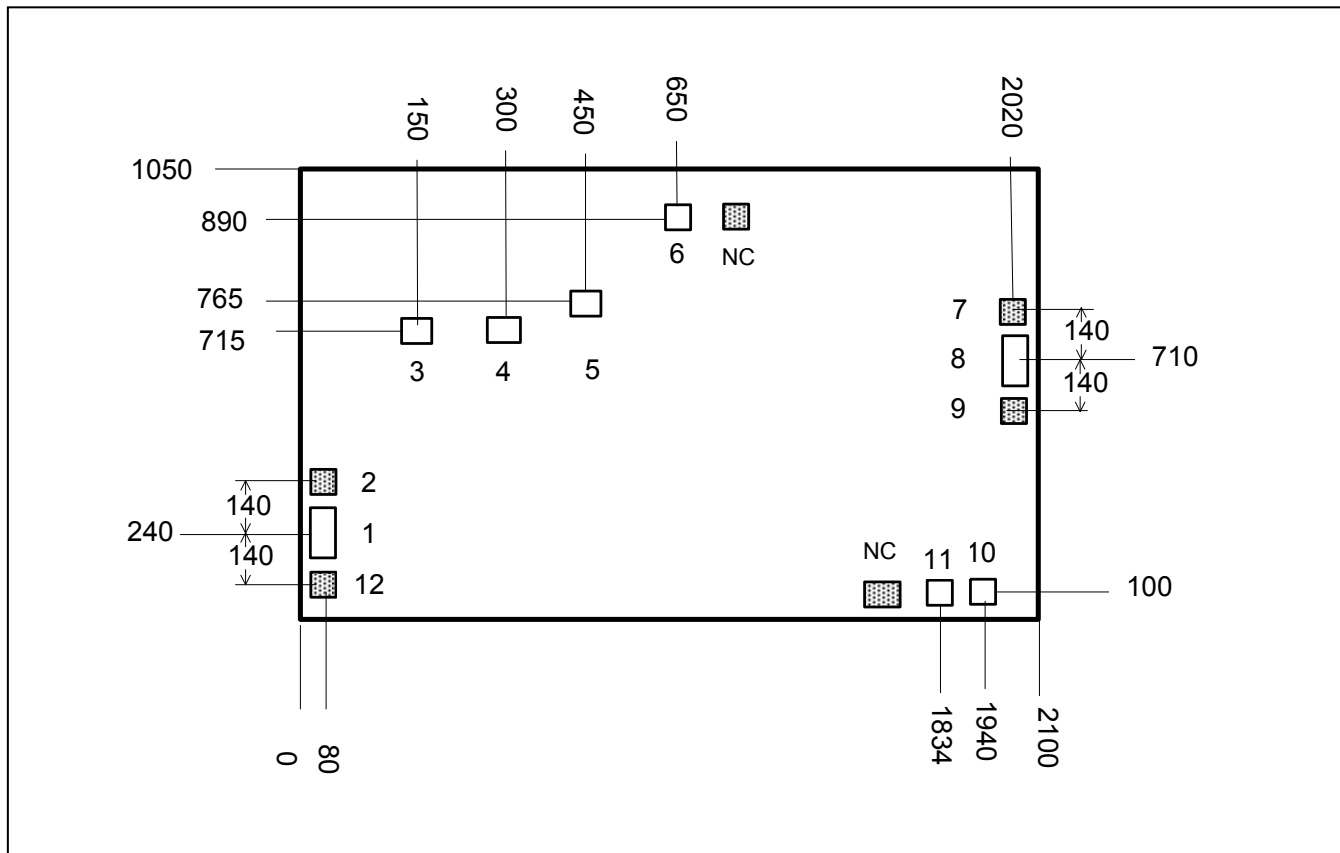

## Bond Pad Detail

Pin #	Size (x)	Size (y)
1	99	155
2, 6, 10, 11, 12	69	69
3, 4, 5	69	89
7, 9	89	69
8	69	168

7. All dimensions shown as microns ( $\mu\text{m}$ ) with a tolerance of  $\pm 5 \mu\text{m}$ , unless otherwise noted.
8. Die thickness is  $100 \mu\text{m} \pm 10 \mu\text{m}$ .

## Handling Procedures

Please observe the following precautions to avoid damage:

## Static Sensitivity

These electronic devices are sensitive to electrostatic discharge (ESD) and can be damaged by static electricity. Proper ESD control techniques should be used when handling these HBM Class 1C devices.

MACOM Technology Solutions Inc. All rights reserved.

Information in this document is provided in connection with MACOM Technology Solutions Inc ("MACOM") products. These materials are provided by MACOM as a service to its customers and may be used for informational purposes only. Except as provided in MACOM's Terms and Conditions of Sale for such products or in any separate agreement related to this document, MACOM assumes no liability whatsoever. MACOM assumes no responsibility for errors or omissions in these materials. MACOM may make changes to specifications and product descriptions at any time, without notice. MACOM makes no commitment to update the information and shall have no responsibility whatsoever for conflicts or incompatibilities arising from future changes to its specifications and product descriptions. No license, express or implied, by estoppel or otherwise, to any intellectual property rights is granted by this document.

THESE MATERIALS ARE PROVIDED "AS IS" WITHOUT WARRANTY OF ANY KIND, EITHER EXPRESS OR IMPLIED, RELATING TO SALE AND/OR USE OF MACOM PRODUCTS INCLUDING LIABILITY OR WARRANTIES RELATING TO FITNESS FOR A PARTICULAR PURPOSE, CONSEQUENTIAL OR INCIDENTAL DAMAGES, MERCHANTABILITY, OR INFRINGEMENT OF ANY PATENT, COPYRIGHT OR OTHER INTELLECTUAL PROPERTY RIGHT. MACOM FURTHER DOES NOT WARRANT THE ACCURACY OR COMPLETENESS OF THE INFORMATION, TEXT, GRAPHICS OR OTHER ITEMS CONTAINED WITHIN THESE MATERIALS. MACOM SHALL NOT BE LIABLE FOR ANY SPECIAL, INDIRECT, INCIDENTAL, OR CONSEQUENTIAL DAMAGES, INCLUDING WITHOUT LIMITATION, LOST REVENUES OR LOST PROFITS, WHICH MAY RESULT FROM THE USE OF THESE MATERIALS.

MACOM products are not intended for use in medical, lifesaving or life sustaining applications. MACOM customers using or selling MACOM products for use in such applications do so at their own risk and agree to fully indemnify MACOM for any damages resulting from such improper use or sale.