

Broadband CATV 8-Way Active Splitter with default loop-through Switch 50 - 1100 MHz

Rev. V1

Features

- Always ON loop-through path
- 8-Way Splitter
- 1.5 dB Gain
- +15 dBm V /Channel Input
- Single 5 Volt Bias
- Lead-Free 4 mm 24-Lead PQFN Package
- RoHS* Compliant and 260°C Reflow Compatible

Description

The MAAM-010237 CATV 8-way active splitter with the default loop-through path is a GaAs MMIC which exhibits low noise figure and distortion in a lead-free 4mm 24-lead PQFN plastic package. The design features 75 Ω inputs and outputs.

This device is ideally suited for multi-tuner set top boxes, home gateways, and other broadband internet based applications.

The MAAM-010237 is fabricated using M/A-COM Technology Solutions' E/D pHEMT process to realize default loop-through operation, low noise and low distortion. The process features full passivation for robust performance and reliability.

Functional Schematic, Default On, Power Off

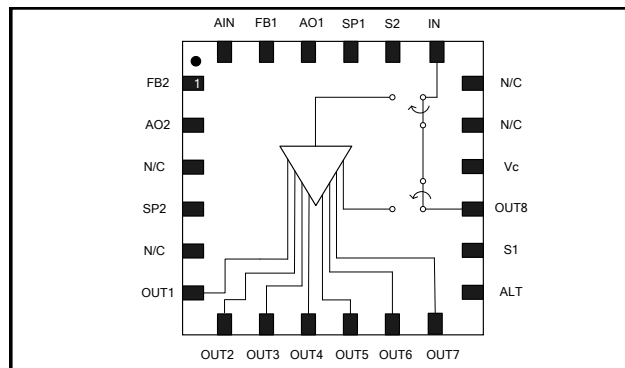

Functional Schematic, Power On

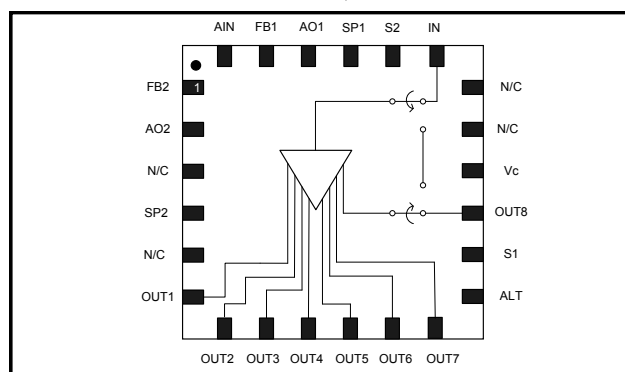

Pin Configuration

Pin No.	Function	Pin No.	Function
1	Feedback 2	13	Alternate Output
2	Amplifier Output 2	14	Switch In
3	No Connection	15	RF Output 8
4	Splitter 2	16	Voltage Control
5	No Connection	17	No Connection
6	RF Output 1	18	No Connection
7	RF Output 2	19	RF Input
8	RF Output 3	20	Switch Output
9	RF Output 4	21	Splitter 1
10	RF Output 5	22	Amplifier Output 1
11	RF Output 6	23	Feedback 1
12	RF Output 7	24	Amplifier Input
		25	Paddle ³

Ordering Information^{1,2}

Part Number	Package
MAAM-010237-TR1000	1000 piece reel
MAAM-010237-TR3000	3000 piece reel
MAAM-010237-001SMB	Sample Test Board

1. Reference Application Note M513 for reel size information.
2. All sample boards include 5 loose parts.

*Restrictions on Hazardous Substances, European Union Directive 02/95/EC.

3. The exposed paddle centered on the package bottom must be connected to RF, DC and thermal ground.

Broadband CATV 8-Way Active Splitter with default loop-through Switch 50 - 1100 MHz

Rev. V1

Electrical Specifications: $T_A = 25^\circ\text{C}$, $Z_0 = 75 \Omega^4$

Parameter	Test Conditions	V _{DD} (V)	V _C (V)	Units	Min.	Typ.	Max.
Gain	In to Out1, 2, 3, 4, 5, 6, 7, or 8 400 MHz 900 MHz	5	3.3	dB	0 -	1.5 4.0	2.6 -
Insertion Loss	In to Out8 400 MHz 900 MHz	0	0	dB	- -	0.6 1.0	- 1.2
Noise Figure	In to Out1, 2, 3, 4, 5, 6, 7, or 8	5	3.3	dB	-	4.75	-
Input Return Loss	Input	5	3.3	dB	-	10	-
Input Return Loss	Input	0	0	dB	-	16	-
Output Return Loss	Output	5	3.3	dB	-	10	-
Output Return Loss	Output	0	0	dB	-	9.5	-
Out to Out Isolation	Out1 to Out2, 3, 4, 5, 6, 7, or 8	5	3.3	dB	-	22	-
Out to Out Isolation	Out1 to 2, 3, 4, 5, 6, or 7	0	0	dB	-	20	-
CTB	132 Ch, +15 dBmV/Ch at the Input	5	3.3	dBc	-	-65	-
CSO	132 Ch, +15 dBmV/Ch at the Input	5	3.3	dBc	-	-50	-
Reverse Isolation	Out1, 2, 3, 4, 5, 6, 7 to In	5	3.3	dB	-	35	-
Reverse Isolation	Out8 to In	5	3.3	dB	-	30	-
Reverse Isolation	Out1, 2, 3, 4, 5, 6, 7 to In	0	0	dB	-	42	-
OIP2	400 MHz, 2-tone, 6 MHz spacing, -10 dBm Pout	5	3.3/0	dBm	-	30	-
OIP3	400 MHz, 2-tone, 6 MHz spacing, -10 dBm Pout	5	3.3/0	dBm	-	22	-
P1dB	400 MHz	5	3.3	dBm	-	6	-
P1dB	400 MHz	5	0	dBm	-	25	-
I _{DD}		5	3.3	mA	-	190	220
I _C		5	3.3	μA	-	230	300

4. The unpowered state is the same as V_{control} = 0 V

Broadband CATV 8-Way Active Splitter with default loop-through Switch 50 - 1100 MHz

Rev. V1

Absolute Maximum Ratings ^{5,6}

Parameter	Absolute Maximum
Max Input Power	+5 dBm
V _{DD}	+10.0 V
V _{CONTROL}	+8.5 V
Junction Temperature ^{7,8}	+150°C
Operating Temperature	-20°C to +85°C
Storage Temperature	-65°C to +150°C

5. Exceeding any one or combination of these limits may cause permanent damage to this device.
6. M/A-COM Technology Solutions does not recommend sustained operation near these survivability limits.
7. Operating at nominal conditions with T_J ≤ +150°C will ensure MTTF > 1 x 10⁶ hours.
8. Junction Temperature (T_J) = T_A + Θ_{JC} * (V * I)
Typical thermal resistance (Θ_{JC}) = 73 °C/W.
 - a) For T_A = 25°C,
T_J = 95 °C @ 5.0 V, 190 mA
 - b) For T_A = 85°C,
T_J = 149 °C @ 5.0 V, 175 mA

PCB Land Pattern

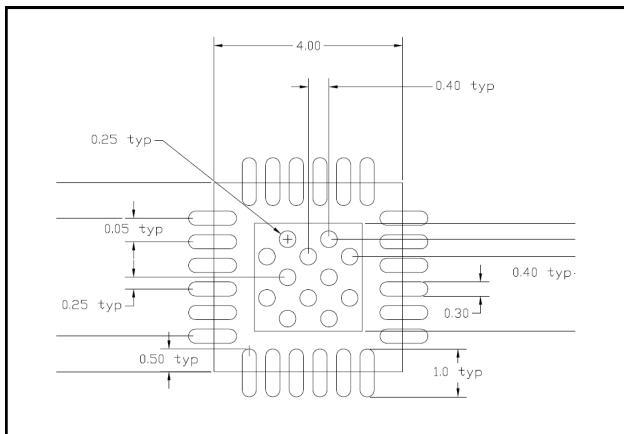

Truth Table ⁹

V _{DD}	V _{CONTROL}	IN - OUT1, 2, 3, 4, 5, 6 or 7	IN - OUT8
5 V	1	On	On
0 V	0	Off	On

9. V_{CONTROL} for Logic "1" = +3 to +5 volts, Logic "0" = 0 ± 0.2 volts.

Handling Procedures

Please observe the following precautions to avoid damage:

Static Sensitivity

Gallium Arsenide Integrated Circuits are sensitive to electrostatic discharge (ESD) and can be damaged by static electricity. Proper ESD control techniques should be used when handling these devices. An external protection circuit using an anti-parallel diode pair can be used to protect the IC.

Please reference application note AN3028 on <http://www.macomtech.com> for further detail.

Broadband CATV 8-Way Active Splitter with default loop-through Switch 50 - 1100 MHz

Rev. V1

Schematic Including Off-Chip Components

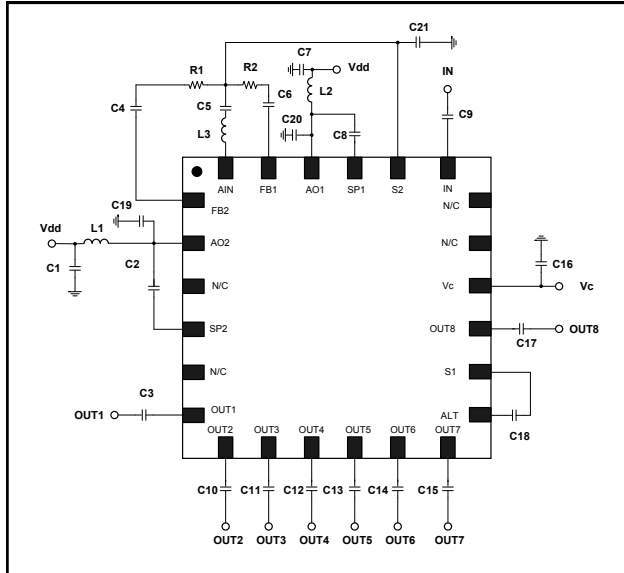

Recommended PCB Layout

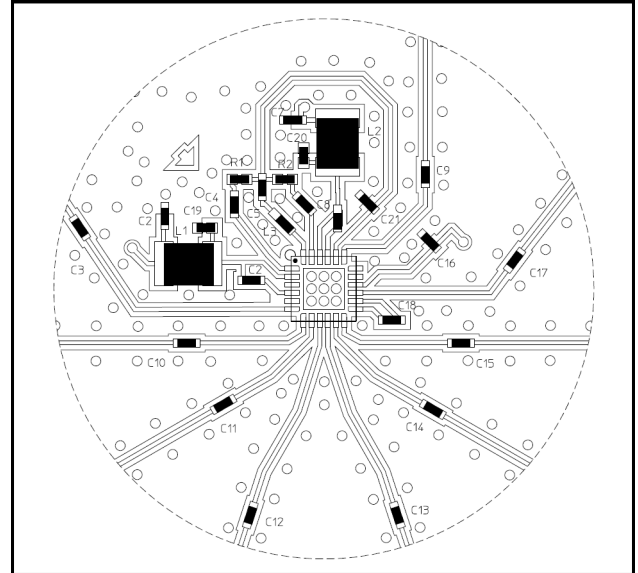

Off-Chip Component Values

Component	Value	Package
C1 - C18	0.01 μ F	0402
C19, C20	2.2 pF	0402
C21	1.5 pF	0402
L1 & L2 ¹⁰	1 μ H	1210
L3	6.8 nH	0402
R1, R2	390 Ω	0402

10. L1 & L2 supplied from EPCOS, part number B82422A1102K100

Block Diagram RF Signal Flow

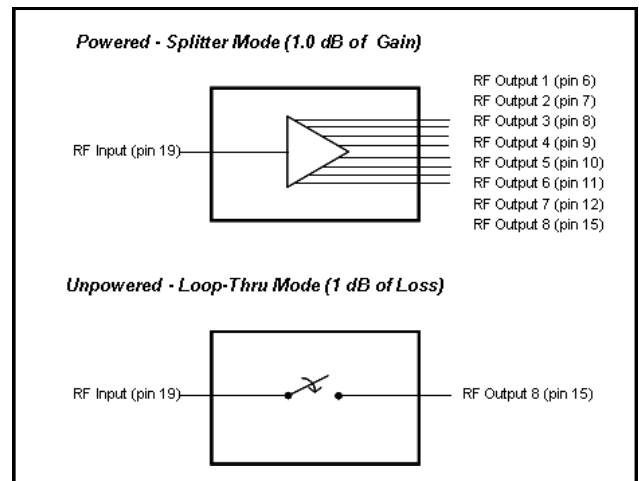

Broadband CATV 8-Way Active Splitter with default loop-through Switch 50 - 1100 MHz

Rev. V1

Typical Performance Curves

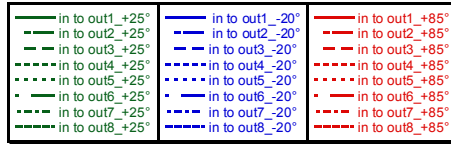

Gain

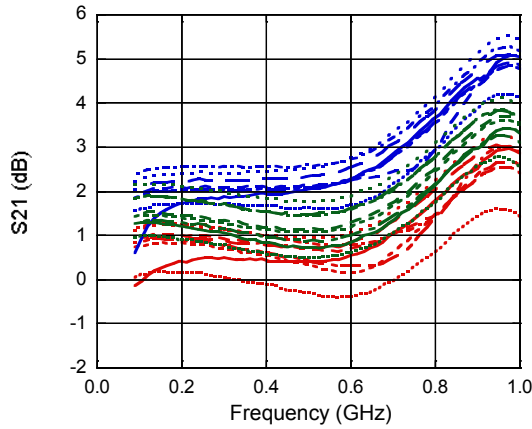

Gain to 3 GHz

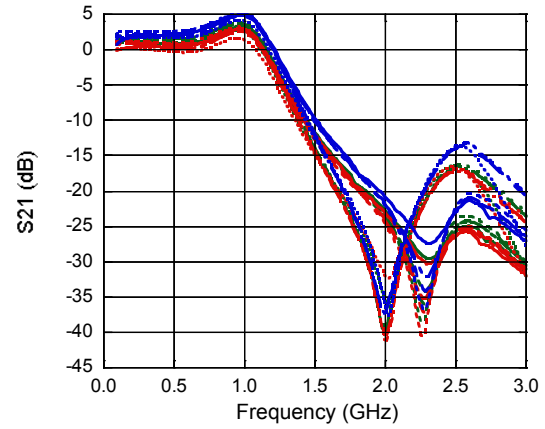

Input Return Loss (power on)

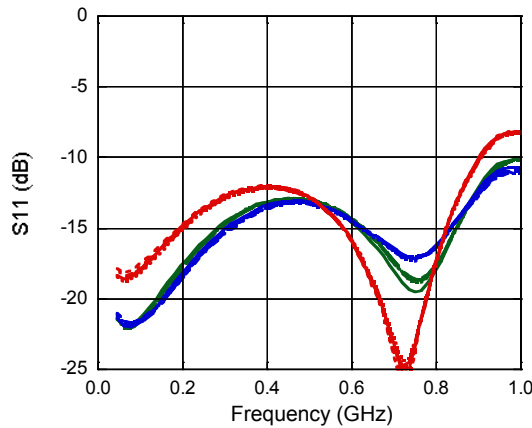

Input Return Loss (power off)

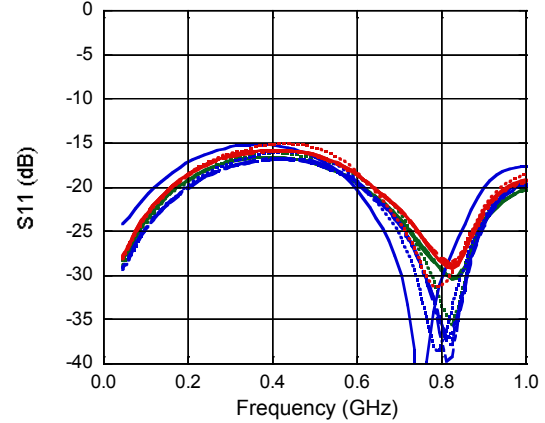

Output Return Loss (power on)

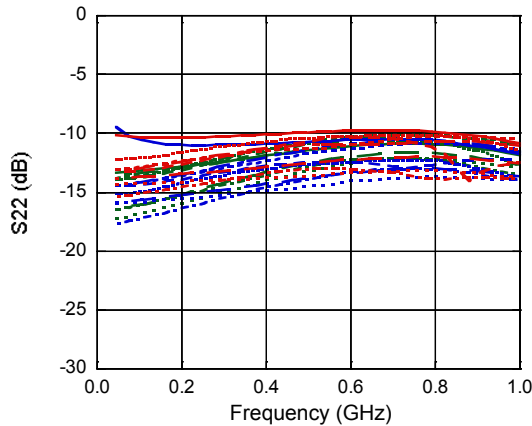

Output Return Loss (power off)

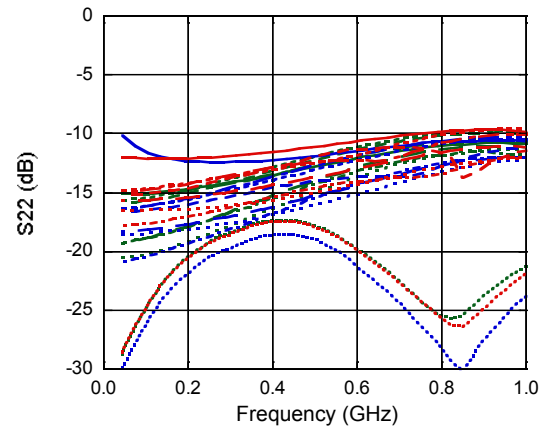

Broadband CATV 8-Way Active Splitter with default loop-through Switch 50 - 1100 MHz

Rev. V1

Typical Performance Curves

Insertion Loss to 1 GHz (power off)

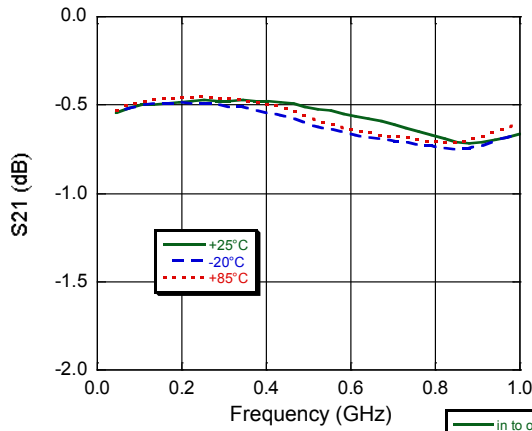

Insertion Loss to 3 GHz (power off)

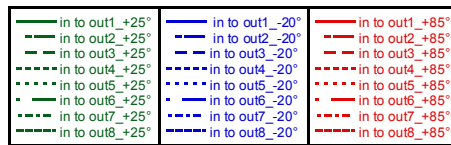
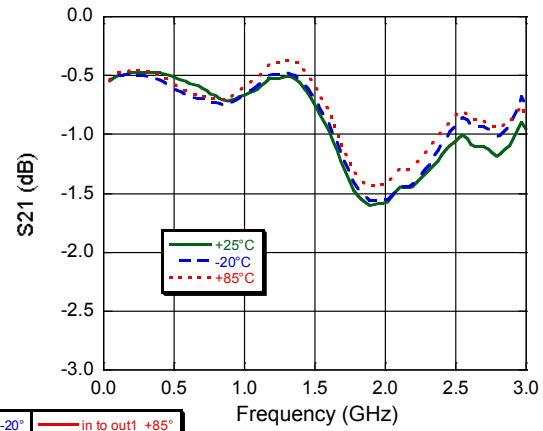

Reverse Isolation to 3 GHz (power on)

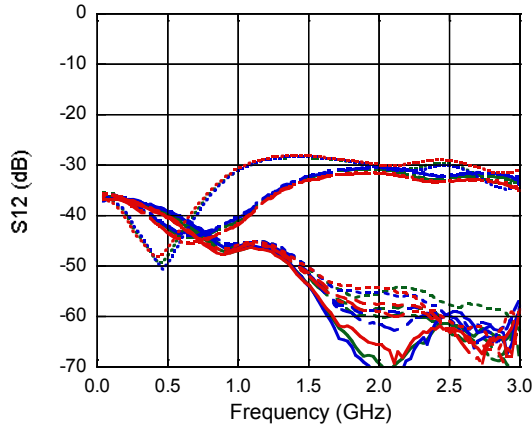

Reverse Isolation to 3 GHz (power off)

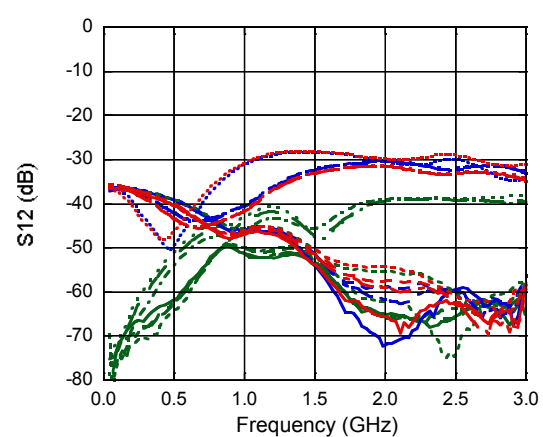

Noise Figure

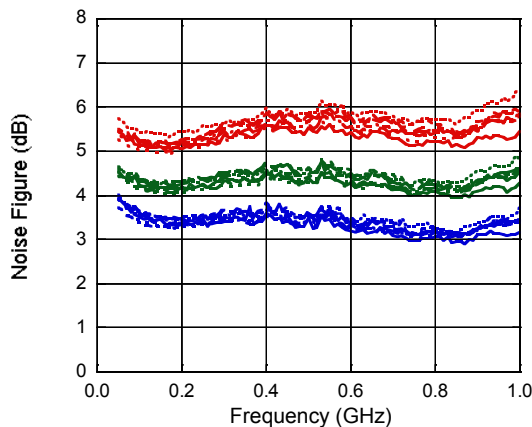

Broadband CATV 8-Way Active Splitter with default loop-through Switch 50 - 1100 MHz

Rev. V1

Typical Performance Curves

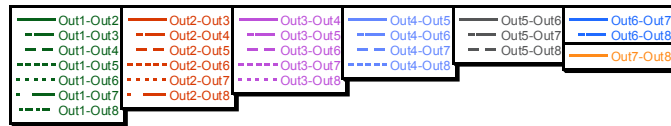

Out to Out Isolation to 1 GHz (power on)

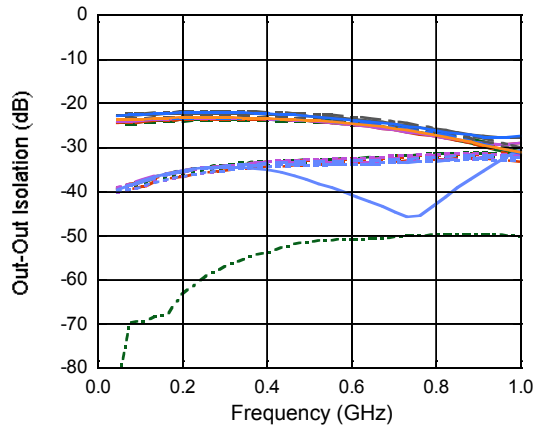

Out to Out Isolation to 3 GHz (power on)

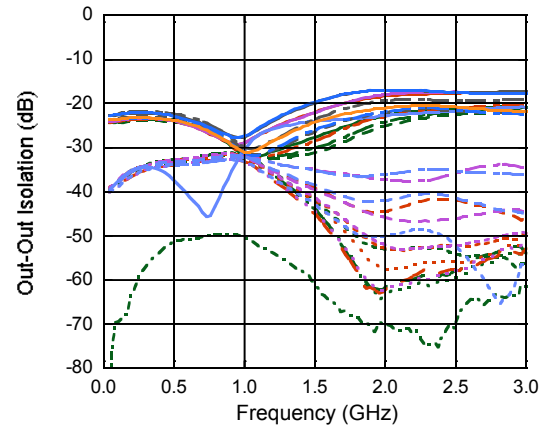

Out to Out Isolation to 1 GHz (power off)

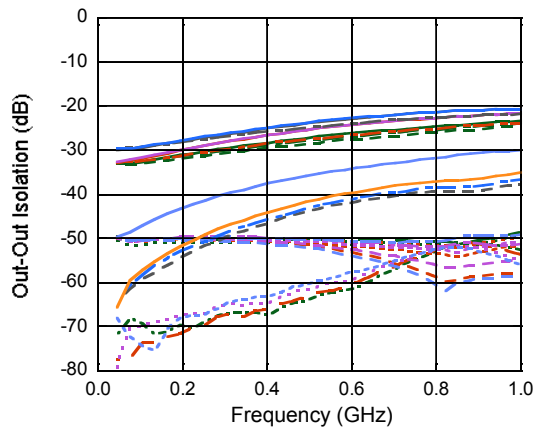

Out to Out Isolation to 3 GHz (power off)

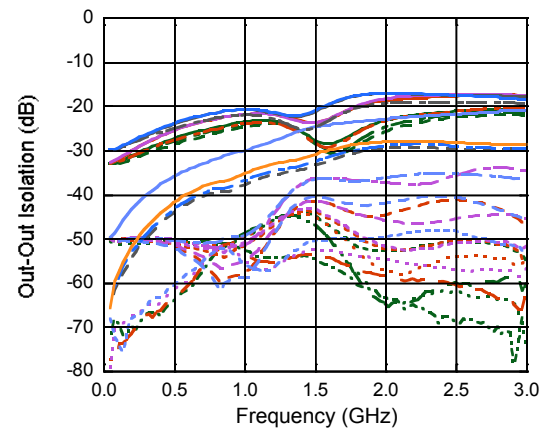

Broadband CATV 8-Way Active Splitter with default loop-through Switch 50 - 1100 MHz

Rev. V1

Lead-Free 4 mm 24-Lead PQFN[†]

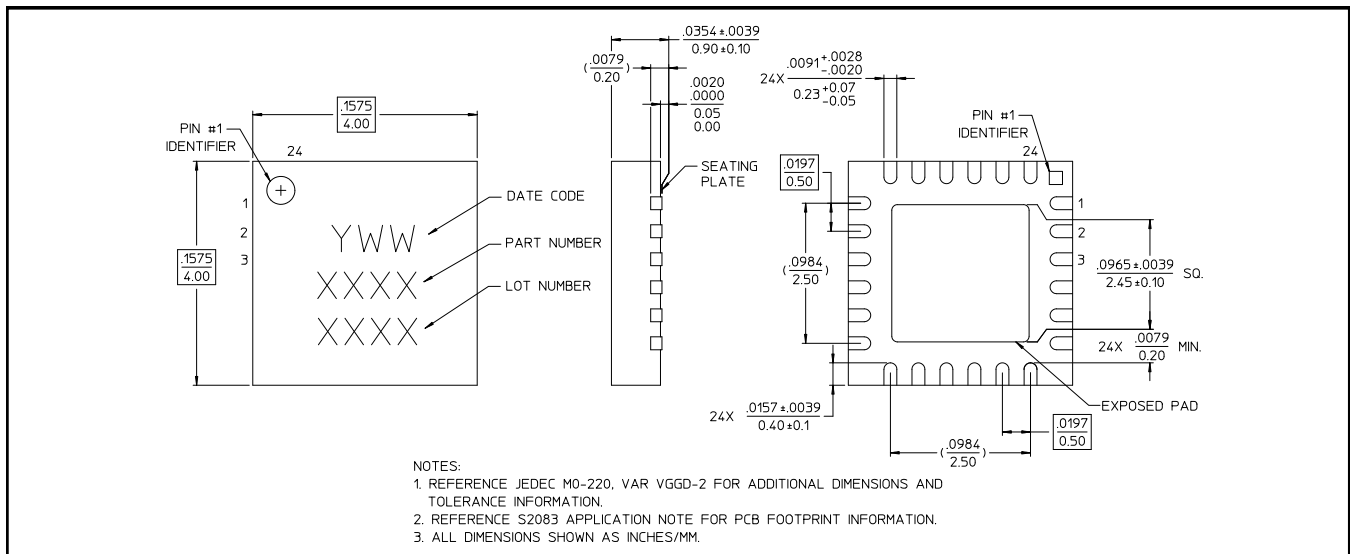

[†] Reference Application Note S2083 for lead-free solder reflow recommendations.
 Meets JEDEC moisture sensitivity level 1 requirements.
 Plating is 100% matte tin over copper.

M/A-COM Technology Solutions Inc. All rights reserved.

Information in this document is provided in connection with M/A-COM Technology Solutions Inc ("MACOM") products. These materials are provided by MACOM as a service to its customers and may be used for informational purposes only. Except as provided in MACOM's Terms and Conditions of Sale for such products or in any separate agreement related to this document, MACOM assumes no liability whatsoever. MACOM assumes no responsibility for errors or omissions in these materials. MACOM may make changes to specifications and product descriptions at any time, without notice. MACOM makes no commitment to update the information and shall have no responsibility whatsoever for conflicts or incompatibilities arising from future changes to its specifications and product descriptions. No license, express or implied, by estoppels or otherwise, to any intellectual property rights is granted by this document.

THESE MATERIALS ARE PROVIDED "AS IS" WITHOUT WARRANTY OF ANY KIND, EITHER EXPRESS OR IMPLIED, RELATING TO SALE AND/OR USE OF MACOM PRODUCTS INCLUDING LIABILITY OR WARRANTIES RELATING TO FITNESS FOR A PARTICULAR PURPOSE, CONSEQUENTIAL OR INCIDENTAL DAMAGES, MERCHANTABILITY, OR INFRINGEMENT OF ANY PATENT, COPYRIGHT OR OTHER INTELLECTUAL PROPERTY RIGHT. MACOM FURTHER DOES NOT WARRANT THE ACCURACY OR COMPLETENESS OF THE INFORMATION, TEXT, GRAPHICS OR OTHER ITEMS CONTAINED WITHIN THESE MATERIALS. MACOM SHALL NOT BE LIABLE FOR ANY SPECIAL, INDIRECT, INCIDENTAL, OR CONSEQUENTIAL DAMAGES, INCLUDING WITHOUT LIMITATION, LOST REVENUES OR LOST PROFITS, WHICH MAY RESULT FROM THE USE OF THESE MATERIALS.

MACOM products are not intended for use in medical, lifesaving or life sustaining applications. MACOM customers using or selling MACOM products for use in such applications do so at their own risk and agree to fully indemnify MACOM for any damages resulting from such improper use or sale.