

Low Noise Amplifier

27 - 31.5 GHz



MAAL-011245-DIE

Rev. V1

Features

- Noise Figure: 1.3 dB
- Gain: 27 dB
- DC Current Regulation Integrated
- Bias Current: 47 mA DC
- Bias Voltage:
 - Drain = +1.5 V
 - Gate = -1.5 V
- Die Size: 1500 x 1000 x 100 μm
- RoHS* Compliant

Applications

- Radar
- SATCOM

Description

The MAAL-011245-DIE is a very low noise figure LNA designed to operate from 27 to 31.5 GHz. It features 27 dB Gain, 1.3 dB and low power consumption. This amplifier uses a single positive and single negative voltage bias and includes on-chip DC current regulation.

This LNA is fully matched to 50 Ω at both input and output ports.

The MAAL-011245-DIE is manufactured using a high performance 70 nm GaAs HEMT technology (D007IH). The MMIC uses gold bonding pads and backside metallization and is fully protected with silicon nitride passivation to obtain the highest level of reliability.

Block Diagram

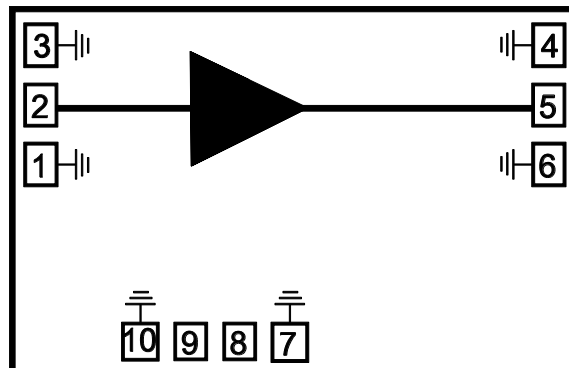

Pad Configuration

Pad #	Function	Function
1,3,4,6,7,10	GND	Ground
2	RF _{IN}	RF Input
5	RF _{OUT}	RF Output
8	V _D	Voltage Drain
9	V _G	Voltage Gate

Ordering Information

Part Number	Package
MAAL-011245-DIE	DIE
MAAL-011245-DIE-SB2	Sample Board

* Restrictions on Hazardous Substances, compliant to current RoHS EU directive.

Low Noise Amplifier

27 - 31.5 GHz



MAAL-011245-DIE

Rev. V1

Electrical Specifications: Freq. = 27 - 31.5 GHz, $V_D = +1.5$ V, $V_G = -1.5$ V

Parameter	Test Conditions	Units	Min.	Typ.	Max.
Noise Figure	@ T_A and nominal conditions	dB	—	1.3	1.5
Gain	@ T_A and nominal conditions	dB	24	27	—
Output P1dB	@ T_A and nominal conditions	dBm	3	5	—
Output IP3	Tone Spacing = 100 MHz $P_{OUT} / \text{Tone} = -9$ dBm	dBm	—	14.5	—
Input Return Loss	@ T_A and nominal conditions	dB	—	-15	—
Output Return Loss	@ T_A and nominal conditions	dB	—	-12	—
Current	Total DC current included DC current regulation	mA	35	47	60

Recommended Operating Conditions

Parameter	Typical
Input RF ports	-35 dBm
DC Supply V_D	+1.5 V
DC Supply V_G	-1.5 V

Absolute Maximum Ratings^{1,2}

Parameter	Absolute Maximum
Input RF ports	15 dBm
DC Voltage Drain Supply	2 V
DC Voltage Gate Supply	-2 V
Junction Temperature ^{3,4}	+150°C
Operating Temperature ³	-40°C to +85°C
Storage Temperature	-40°C to +150°C

Handling Procedures

Please observe the following precautions to avoid damage:

Static Sensitivity

These electronic devices are sensitive to electrostatic discharge (ESD) and can be damaged by static electricity. Proper ESD control techniques should be used when handling these HBM Class 0 devices.

- Exceeding any one or combination of these limits may cause permanent damage to this device.
- MACOM does not recommend sustained operation near these survivability limits.
- Operating at nominal conditions with $T_J \leq +150^\circ\text{C}$ will ensure $\text{MTTF} > 1 \times 10^{11}$ hours.
- Junction Temperature (T_J) = $T_C + \Theta_{jc} * (V * I)$
Typical thermal resistance (Θ_{jc}) = 443 °C/W.
 - For $T_C = +25^\circ\text{C}$,
 $T_J = 54.9^\circ\text{C} @ 1.5$ V, 47 mA
 - For $T_C = +85^\circ\text{C}$,
 $T_J = 120.5^\circ\text{C} @ 1.5$ V, 47 mA

Low Noise Amplifier

27 - 31.5 GHz



MAAL-011245-DIE

Rev. V1

Typical Performance Curves: $T_c = 25^\circ\text{C}$ During on Wafer Measurements using Probe Cards: S-Parameters with 0.1 nH Assumed Wirebond

Noise Figure over Frequency

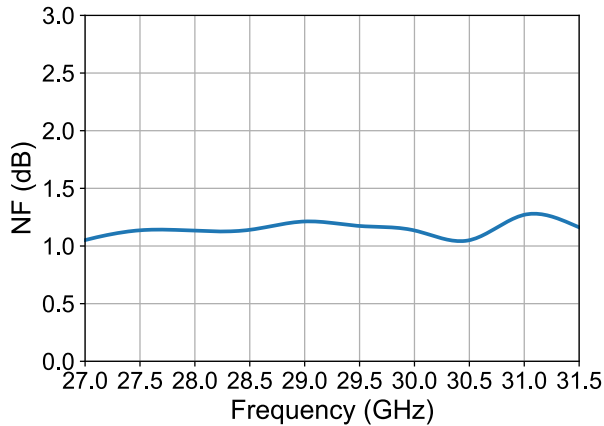

Gain over Frequency

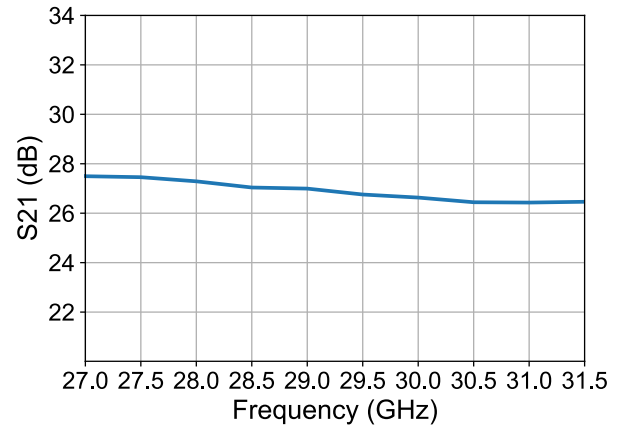

Input Return Loss over Frequency

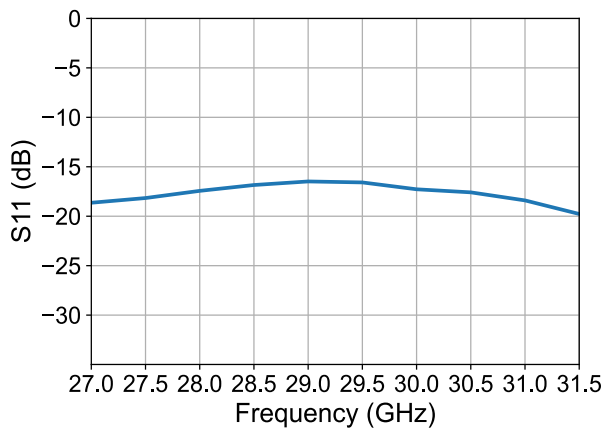

Output Return Loss over Frequency

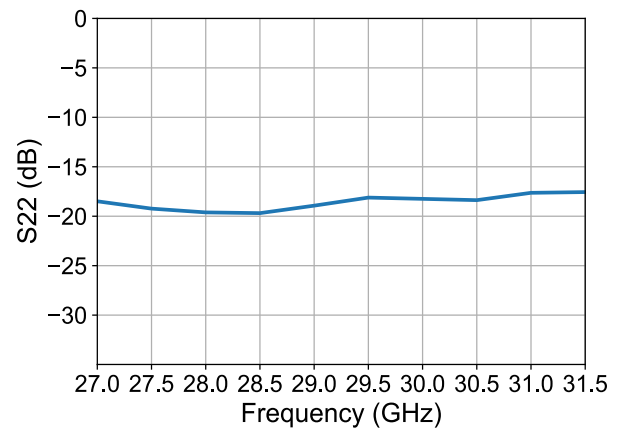

Typical Performance Curves: using Connectorized PCB with De-Embedding at Different Temperatures: S-Parameters in CW at PCB level with De-Embedding

Noise Figure over Frequency

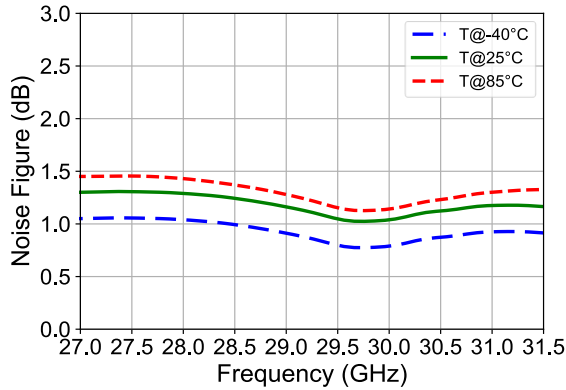

Gain over Frequency

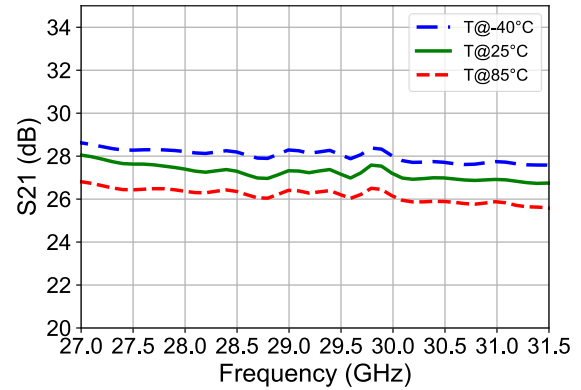

Input Return Loss over Frequency

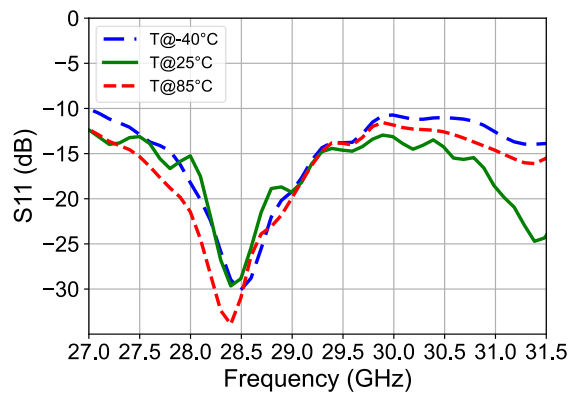

Output Return Loss over Frequency

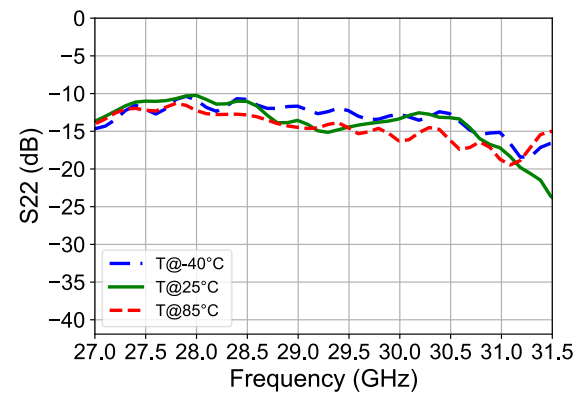

Output Power at 1dB Compression over Frequency

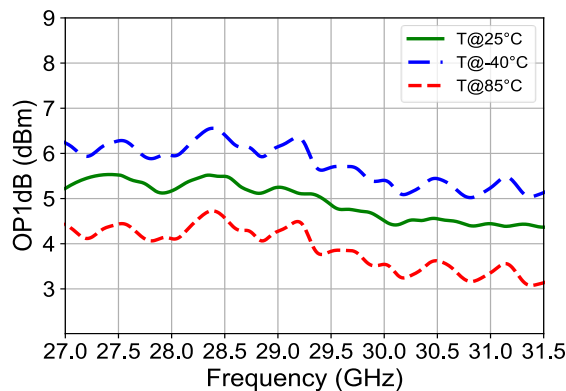

Three-order Interception Point over Frequency

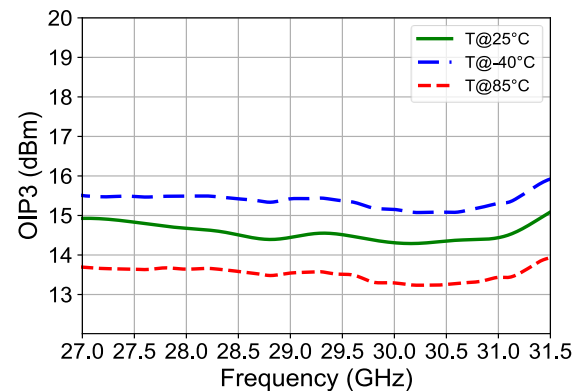

**Typical Performance Curves In board with De-Embedding at Different Temperatures:
 Power measurements in CW at PCB level with De-Embedding**

Output Power over Input Power @ 30 GHz

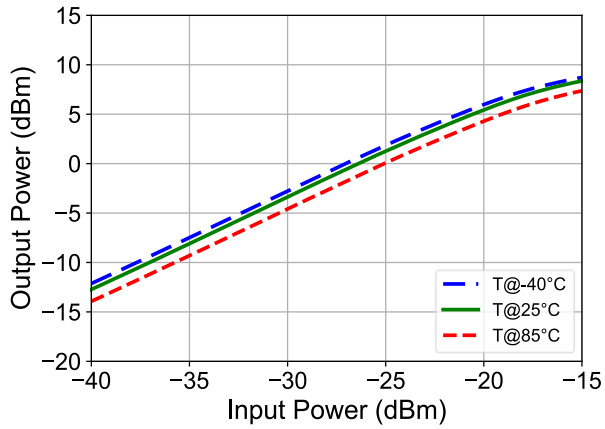

IM3 over Input Power @ 30 GHz

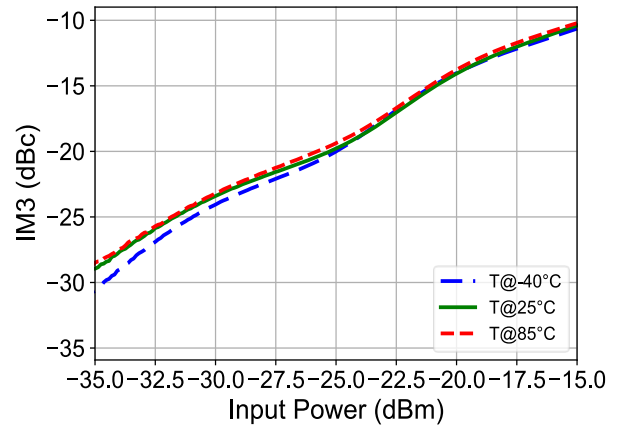

RF Access Line & Connector Losses over Frequency

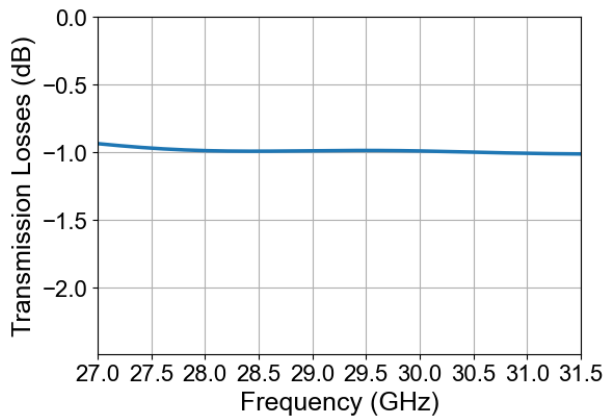

Low Noise Amplifier 27 - 31.5 GHz



MAAL-011245-DIE

Rev. V1

PCB Layout

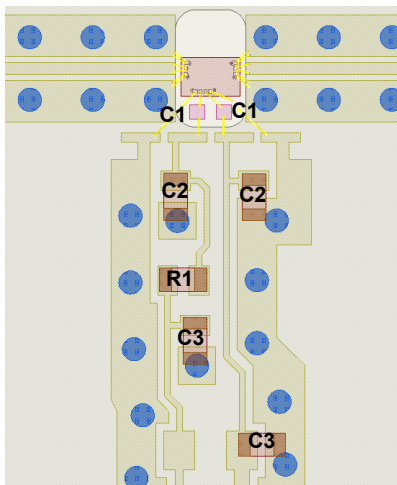
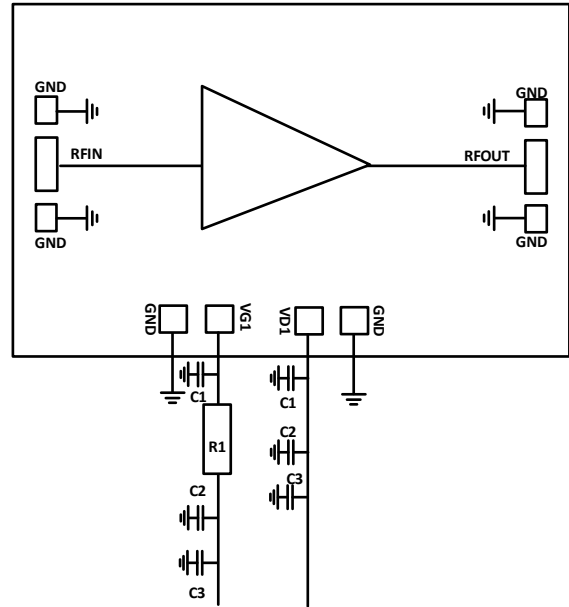
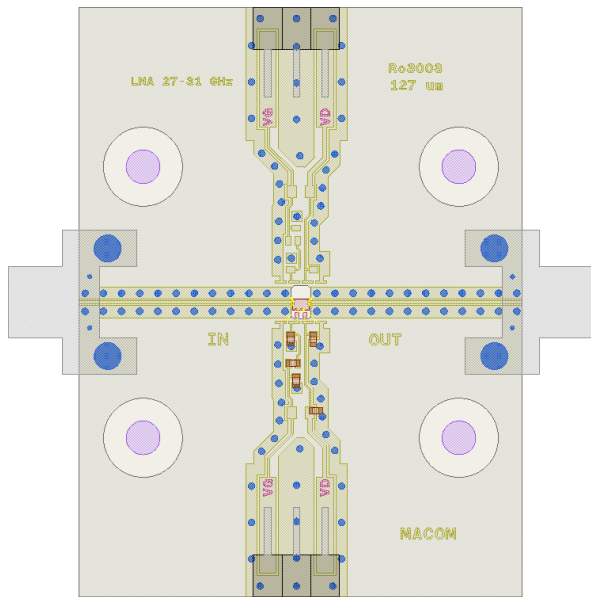

Parts List

Part	Value	Case Style	Manufacturer	type	Manufacturer's Part number
C1	47 pF	0.015 mils	PRESIDIO	Single layer capacitor	LSA1515B470K1U5C
C2	10 nF	0402 INCH	Murata	SMD Multi Layer Capacitor	GRM155R61E103KA01D
C3	100 nF	0402 INCH	Murata	SMD Multi Layer Capacitor	GRM155R61E225ME11D
R1	0 Ω	0402 INCH	Panasonic	SMD Resistor	ERJ-S020R00X

Low Noise Amplifier 27 - 31.5 GHz



MAAL-011245-DIE

Rev. V1

Die Outline

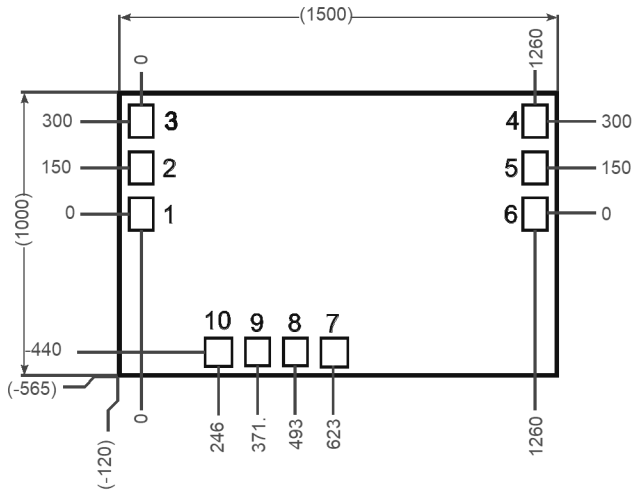

Recommended Bonding Diagram

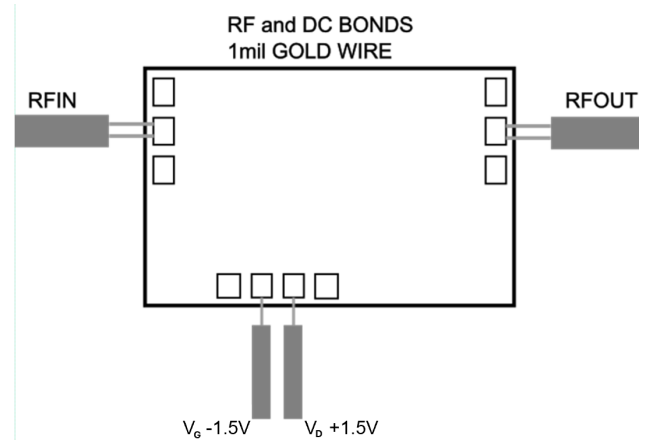

Pads Dimensions (μm)

Pad #	X	Y
1,2,3, 4,5,6	80	100
7,10	84	90
8,9	80	90

Revision History

Rev	Date	Change description
V1	4/5/24	Production Release

MACOM Technology Solutions Inc. ("MACOM"). All rights reserved.

These materials are provided in connection with MACOM's products as a service to its customers and may be used for informational purposes only. Except as provided in its Terms and Conditions of Sale or any separate agreement, MACOM assumes no liability or responsibility whatsoever, including for (i) errors or omissions in these materials; (ii) failure to update these materials; or (iii) conflicts or incompatibilities arising from future changes to specifications and product descriptions, which MACOM may make at any time, without notice. These materials grant no license, express or implied, to any intellectual property rights.

THESE MATERIALS ARE PROVIDED "AS IS" WITH NO WARRANTY OR LIABILITY, EXPRESS OR IMPLIED, RELATING TO SALE AND/OR USE OF MACOM PRODUCTS INCLUDING FITNESS FOR A PARTICULAR PURPOSE, MERCHANTABILITY, INFRINGEMENT OF INTELLECTUAL PROPERTY RIGHT, ACCURACY OR COMPLETENESS, OR SPECIAL, INDIRECT, INCIDENTAL, OR CONSEQUENTIAL DAMAGES WHICH MAY RESULT FROM USE OF THESE MATERIALS.

MACOM products are not intended for use in medical, lifesaving or life sustaining applications. MACOM customers using or selling MACOM products for use in such applications do so at their own risk and agree to fully indemnify MACOM for any damages resulting from such improper use or sale.