

Distributed Low Noise Amplifier

2 - 20 GHz



MAAL-011182-DIE

Rev. V2

Features

- 15 dB Gain
- 2.5 dB Noise Figure
- 25 dBm Output IP3
- 5 V Drain Supply
- Bare Die: 3044 x 1304 x 100 μm
- RoHS* Compliant

Applications

- ISM / Multi Market
- Test & Measurement

Description

The MAAL-011182-DIE is a wideband distributed low noise amplifier with an operating frequency range of 2 to 20 GHz. This LNA has a 2.5 dB typical noise figure, 15 dB typical gain, and a 25 dBm typical output IP3. The output P1dB is 14 dBm typical with a 26 dBm typical P3dB. This LNA is biased with a single 5 V supply. The typical current draw is 65 mA.

No external matching components are required. There are internal DC blocking capacitors at the input and output pins.

The MAAL-011182-DIE is designed for wideband low noise applications such as test equipment. It is available as a bare die. This LNA is also available in a 5 mm, 32 lead PQFN package under part number MAAL-011182.

Functional Schematic

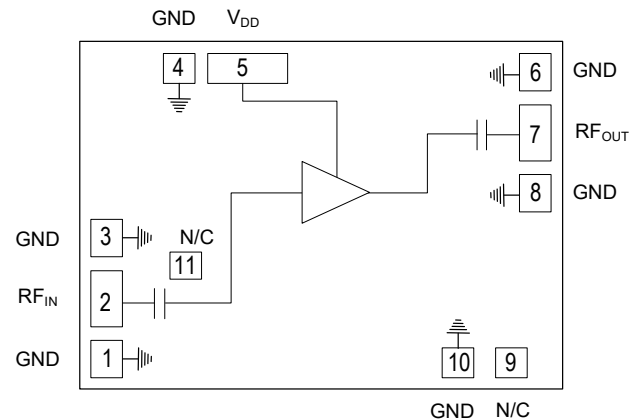

Pad Configuration^{1,2}

Pad #	Pad Name	Description
1,3,4,6,8,10	GND	Ground
2	RF _{IN}	RF Input
5	V _{DD}	Voltage Supply
7	RF _{OUT}	RF Output
9, 11	N/C	No Connection

1. Backside of die must be connected to RF, DC, and thermal ground.
2. It is not necessary to connect ground pads. Via holes connect these pads to the backside ground.

Ordering Information

Part Number	Package
MAAL-011182-DIE	Bare Die
MAAL-011182-DIESMB	Sample Board

* Restrictions on Hazardous Substances, compliant to current RoHS EU directive.

Distributed Low Noise Amplifier

2 - 20 GHz



MAAL-011182-DIE

Rev. V2

Electrical Specifications: $V_{DD} = +5\text{ V}$, $I_{DQ} = 65\text{ mA}$, $T_A = 25^\circ\text{C}$, $Z_0 = 50\ \Omega$

Parameter	Test Conditions	Units	Min.	Typ.	Max.
Gain	2 - 6 GHz 6 - 14 GHz 14 - 20 GHz	dB	13	15.00 15.25 16.00	—
Gain Flatness	2 - 6 GHz 6 - 14 GHz 14 - 20 GHz	dB	—	+/-0.5 +/-0.5 +/-0.5	—
Gain Variation vs. Temperature	10 GHz	dB/°C	—	0.02	—
Noise Figure	2 GHz 4 GHz 8 GHz 10 GHz 18 GHz 20 GHz	dB	—	3.8 2.8 1.4 1.7 2.9 3.6	4.75 3.50 2.25 2.50 4.00 4.50
Input Return Loss	2 - 20 GHz	dB	8	13	—
Output Return Loss	2 - 20 GHz	dB	8	12	—
P1dB	2 - 6 GHz 6 - 14 GHz 14 - 20 GHz	dBm	—	15 14 12	—
P3dB	2 - 6 GHz 6 - 14 GHz 14 - 20 GHz	dBm	—	17 16 15	—
OIP3	2 - 6 GHz 6 - 14 GHz 14 - 20 GHz	dBm	22 21 18	26 25 22	—
IDD	—	mA	—	65	—

Maximum Operating Conditions

Parameter	Maximum
TX Input Power	6 dBm
Operating Voltage	6 V
Junction Temperature ^{3,4}	+160°C
Operating Temperature	-40°C to +85°C

- Operating at nominal conditions with $T_J \leq +160^\circ\text{C}$ will ensure $\text{MTTF} > 1 \times 10^6$ hours.
- TX Junction Temp. (T_J) = $T_C + \Theta_{jc} * ((V * I) - (P_{OUT} - P_{IN}))$.
Typical TX thermal resistance (Θ_{jc}) = 86.2°C/W.
a) For $T_C = +85^\circ\text{C}$,
 $T_J = 113^\circ\text{C}$ @ 5 V, 65 mA

Absolute Maximum Ratings^{5,6}

Parameter	Absolute Maximum
TX Input Power	8 dBm
VDD	7 V
Junction Temperature ⁷	+180°C
Storage Temperature	-55°C to +150°C

- Exceeding any one or combination of these limits may cause permanent damage to this device.
- MACOM does not recommend sustained operation near these survivability limits.
- Junction temperature directly effects device MTTF. Junction temperature should be kept as low as possible to maximize lifetime.

Typical Performance Curves

Gain

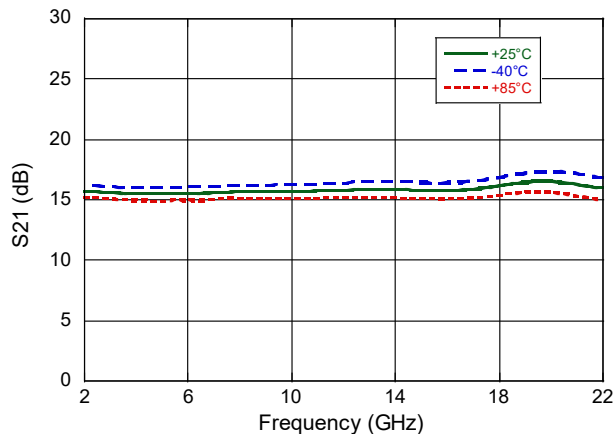

Isolation

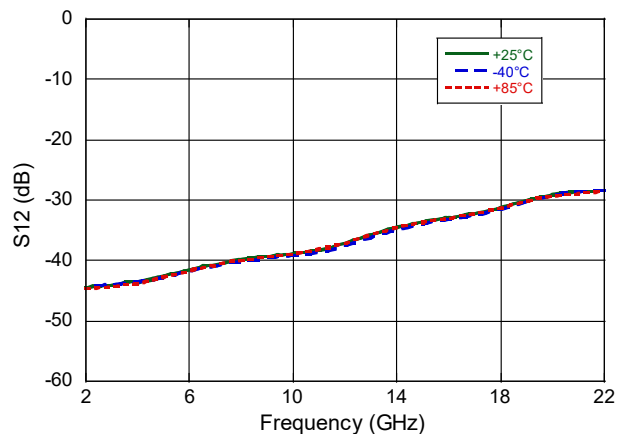

Input Return loss

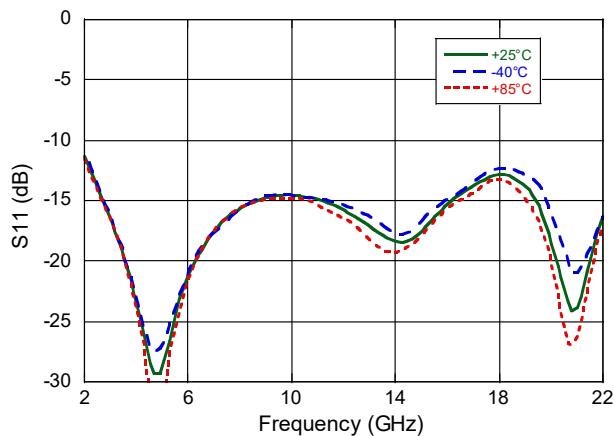

Output Return Loss

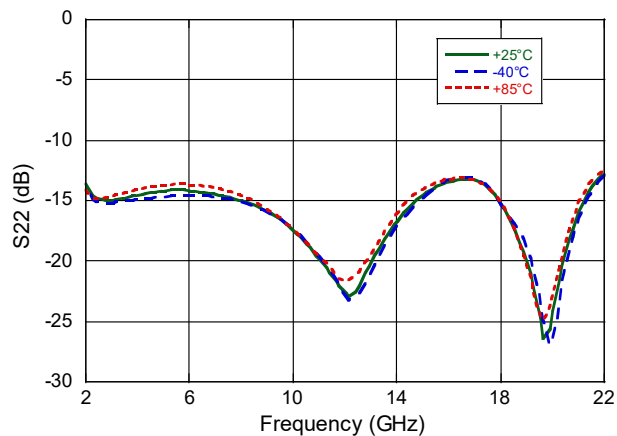

Noise Figure

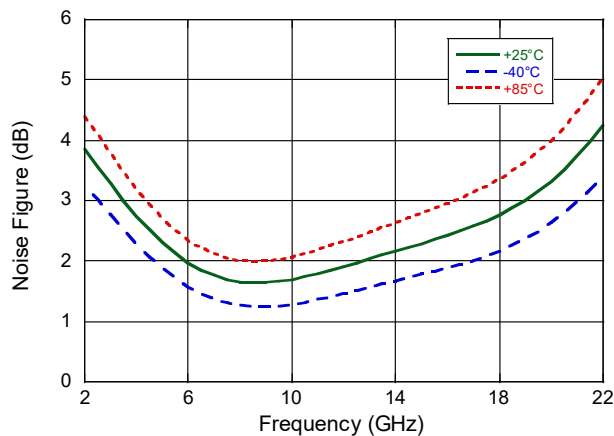

Distributed Low Noise Amplifier

2 - 20 GHz



MAAL-011182-DIE

Rev. V2

Typical Performance Curves

P1dB

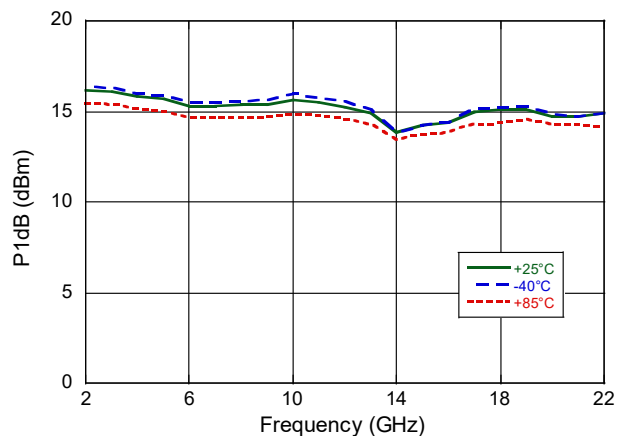

OIP3

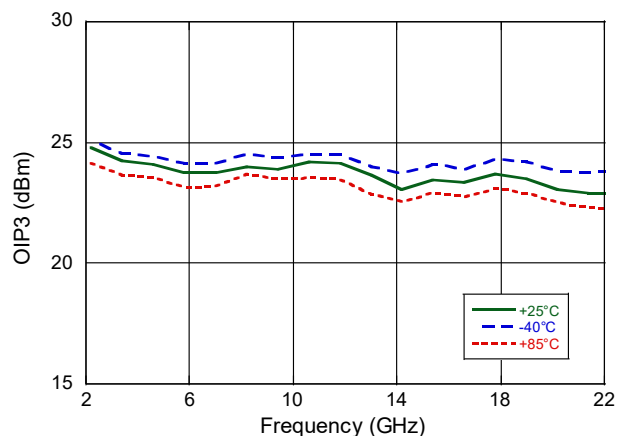

P1dB vs. VDD

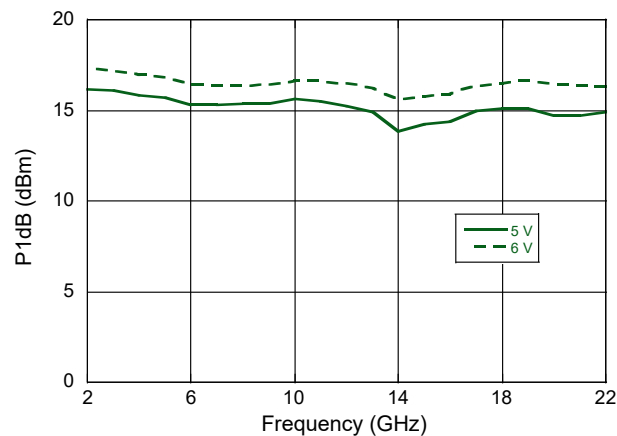

OIP3 vs. VDD

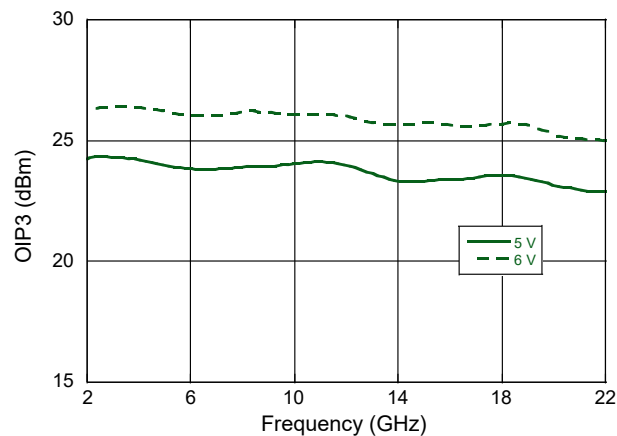

P3dB vs. VDD

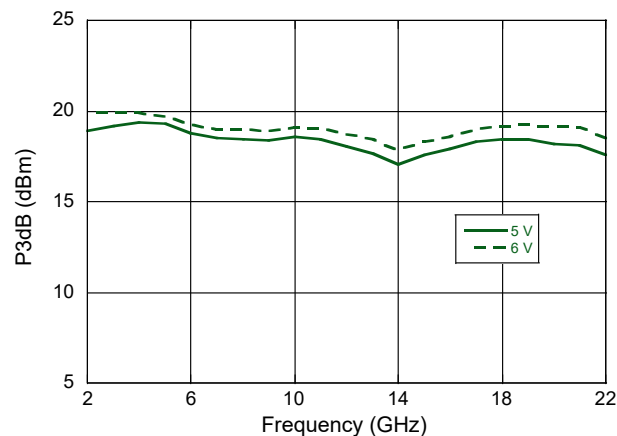

Recommended Bonding Diagram⁸

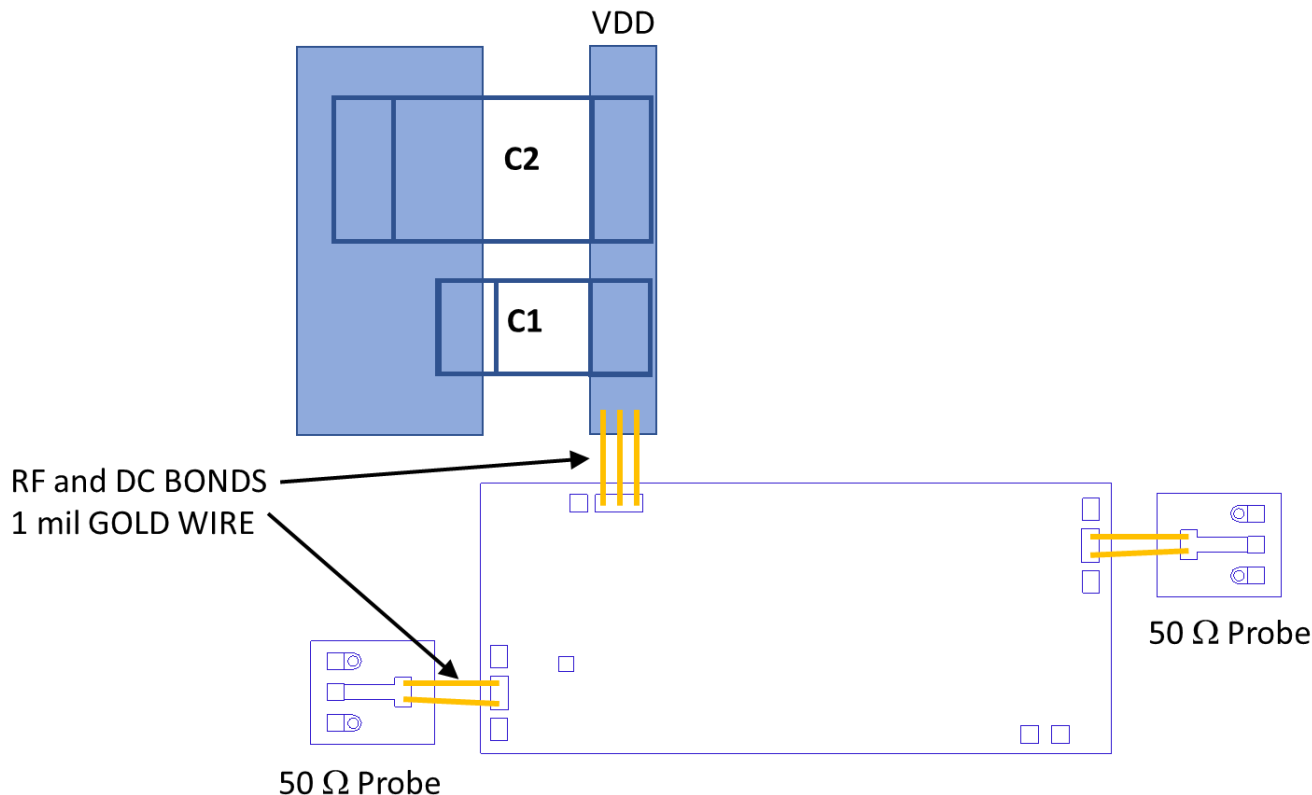

8. The 50 Ω probe stand-offs are for engineering test only. It is not necessary to wirebond the GSG ground pads 1,3,6 and 8 to ground as they are already connected to ground through backside vias.

Die Attachment

This product is manufactured from 0.100 mm (0.004”) thick GaAs substrate and has vias through to the backside to enable grounding to the circuit.

Recommended conductive epoxy is Namics Unimec XH9890-6. Epoxy should be applied and cured in accordance with the manufacturer’s specifications and should avoid contact with the top of the die.

Parts List

Part #	Value	Case Style
C1	100 pF	0402
C2	1000 pF	0603

Distributed Low Noise Amplifier

2 - 20 GHz



MAAL-011182-DIE

Rev. V2

Die Outline^{9,10,11,12}

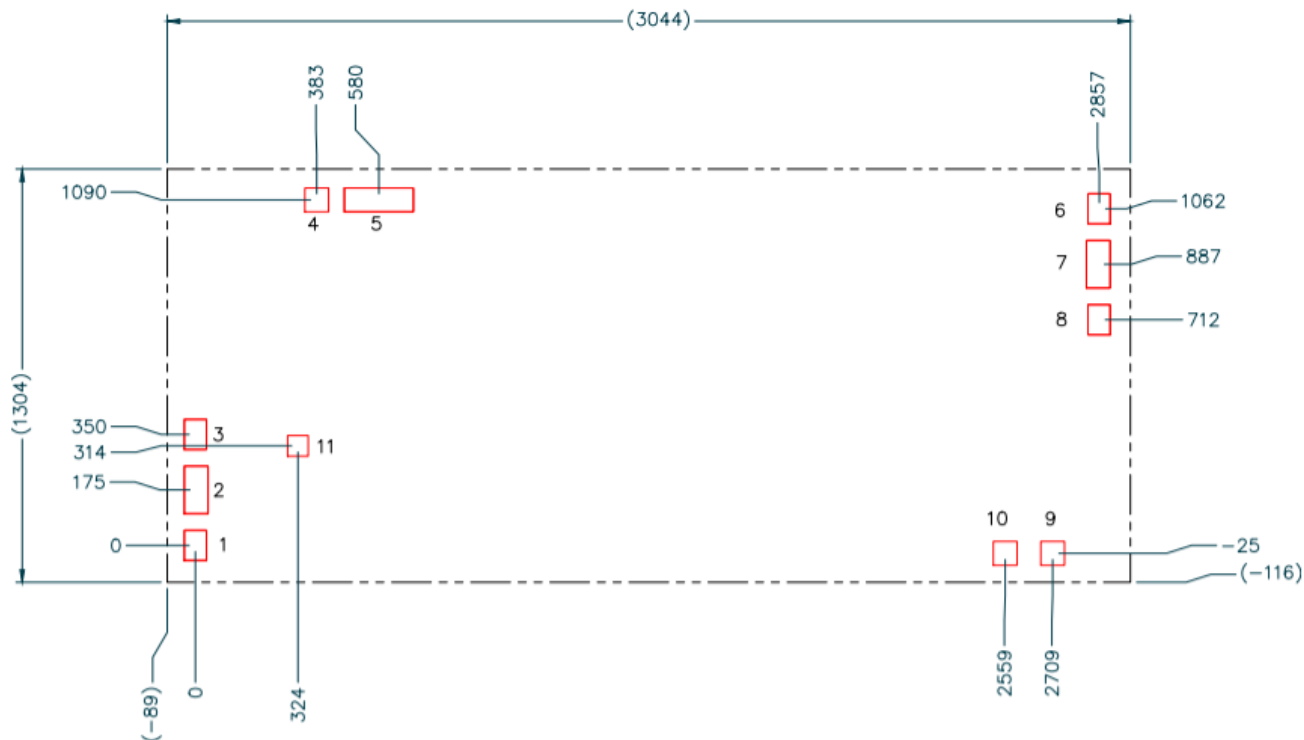

9. Unless otherwise specified, all dimensions shown are μm with a tolerance of $\pm 5 \mu\text{m}$.
10. Die thickness is $100 \pm 10 \mu\text{m}$.
11. Bond pad/backside metallization: Gold.
12. Die size reflects cut dimensions. Saw or laser kerf reduces die size $\sim 25 \mu\text{m}$ each dimension.

Bond Pad Dimensions (μm)

Pad #	X	Y
1,3,6,8	70	85
2,7	75	150
4,9,10	75	75
5	218	75
11	65	65

Handling Procedures

Please observe the following precautions to avoid damage:

Static Sensitivity

These electronic devices are sensitive to electrostatic discharge (ESD) and can be damaged by static electricity. Proper ESD control techniques should be used when handling these HBM Class 1A devices.

Distributed Low Noise Amplifier

2 - 20 GHz



MAAL-011182-DIE

Rev. V2

MACOM Technology Solutions Inc. ("MACOM"). All rights reserved.

These materials are provided in connection with MACOM's products as a service to its customers and may be used for informational purposes only. Except as provided in its Terms and Conditions of Sale or any separate agreement, MACOM assumes no liability or responsibility whatsoever, including for (i) errors or omissions in these materials; (ii) failure to update these materials; or (iii) conflicts or incompatibilities arising from future changes to specifications and product descriptions, which MACOM may make at any time, without notice. These materials grant no license, express or implied, to any intellectual property rights.

THESE MATERIALS ARE PROVIDED "AS IS" WITH NO WARRANTY OR LIABILITY, EXPRESS OR IMPLIED, RELATING TO SALE AND/OR USE OF MACOM PRODUCTS INCLUDING FITNESS FOR A PARTICULAR PURPOSE, MERCHANTABILITY, INFRINGEMENT OF INTELLECTUAL PROPERTY RIGHT, ACCURACY OR COMPLETENESS, OR SPECIAL, INDIRECT, INCIDENTAL, OR CONSEQUENTIAL DAMAGES WHICH MAY RESULT FROM USE OF THESE MATERIALS.

MACOM products are not intended for use in medical, lifesaving or life sustaining applications. MACOM customers using or selling MACOM products for use in such applications do so at their own risk and agree to fully indemnify MACOM for any damages resulting from such improper use or sale.