

Low Phase Noise Amplifier

6 - 12 GHz



MAAL-011155-DIE

Rev. V2

Features

- Phase Noise: 167 dBc/Hz @ 10 kHz
- Gain: 15 dB
- P1dB: 20 dBm
- Bias Voltage: $V_{CC} = +5\text{ V}$
- Bias Current: $I_{CQ} = 90\text{ mA}$
- 50 Ω Matched Input and Output
- Positive Voltage Only
- Die Size: 2265 x 1695 x 100 μm
- RoHS* Compliant

Applications

- Radar
- Electronic Countermeasures
- Test and Measurement
- Microwave Communication Systems

Description

The MAAL-011155-DIE is an easy to use low phase noise amplifier chip. It operates from 6 - 12 GHz and provides 167 dBc/Hz phase noise, 15 dB gain and 20 dBm P1dB. The input and output are fully matched to 50 Ω with typical return loss >15 dB.

This product is fabricated using a GaAs HBT process which features full passivation for enhanced reliability.

The MAAL-011155-DIE is ideally suited for Radar, Test and Measurement, EW, ECM, and Microwave Communication Systems applications.

Ordering Information

Part Number	Package
MAAL-011155-DIE	Gel Pack

Functional Schematic

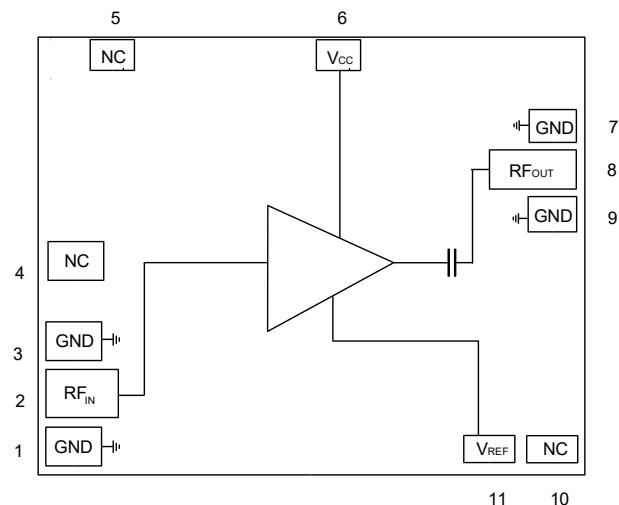

Pad Configuration¹

Pad #	Pad Name	Description
1,3,7,9	GND	DC + RF Ground to Backside Via
2	RF _{IN}	RF Input
4,5,10	NC	Not Connect
6	V _{CC}	Supply Voltage
8	RF _{OUT}	RF Output
11	V _{REF}	Reference Voltage

1. Backside of die must be connected to RF, DC and thermal ground.

* Restrictions on Hazardous Substances, compliant to current RoHS EU directive.

Low Phase Noise Amplifier

6 - 12 GHz



MAAL-011155-DIE

Rev. V2

Electrical Specifications:

Freq. = 6 - 12 GHz, $T_A = +25^\circ\text{C}$, $V_{CC} = +5\text{ V}$, $Z_0 = 50\ \Omega$ (Based on probed die production data)

Parameter	Test Conditions	Units	Min.	Typ.	Max.
Gain	$P_{IN} = -15\text{ dBm}$ 6 GHz 8 GHz 12 GHz	dB	14.0 14.0 13.5	16.0 16.0 15.5	—
Gain Flatness	—	dB	—	± 0.2	—
Gain Variation over Temperature	—	dB/ $^\circ\text{C}$	—	0.025	—
Output Power	$P_{IN} = +5.0\text{ dBm}$, 6 GHz $P_{IN} = +4.7\text{ dBm}$, 9 GHz $P_{IN} = +3.0\text{ dBm}$, 12 GHz	dBm	18.0 17.5 15.0	20.0 19.5 17.0	—
Noise Figure	—	dB	—	5.1	—
Input Return Loss	—	dB	—	17	—
Output Return Loss	—	dB	—	16	—
P1dB	6 GHz	dBm	—	20	—
P3dB	6 GHz	dBm	—	21	—
OIP3	6 GHz, -10 dBm per tone	dBm	—	31.5	—
Phase Noise	6 GHz, P1dB 100 Hz 1 kHz 10 kHz 1 MKz	dBc/Hz	—	146 160 167 175	—
I _{cc}	—	mA	—	90	—

Absolute Maximum Ratings^{2,3}

Parameter	Absolute Maximum
Input Power	14 dBm
V_{CC}	6 V
I_{CC}	105 mA
Junction Temperature ^{4,5}	+150 $^\circ\text{C}$
Operating Temperature	-40 $^\circ\text{C}$ to +85 $^\circ\text{C}$
Storage Temperature	-40 $^\circ\text{C}$ to +150 $^\circ\text{C}$

- Exceeding any one or combination of these limits may cause permanent damage to this device.
- MACOM does not recommend sustained operation near these survivability limits.
- Operating at nominal conditions with $T_J \leq +150^\circ\text{C}$ will ensure $\text{MTTF} > 1 \times 10^6$ hours.
- Junction Temperature (T_J) = $T_C + \Theta_{jc} * (V * I)$
Typical thermal resistance (Θ_{jc}) = 20.7 $^\circ\text{C}/\text{W}$.
 - For $T_C = +25^\circ\text{C}$,
 $T_J = 38^\circ\text{C}$ @ 6 V, 105 mA
 - For $T_C = +85^\circ\text{C}$,
 $T_J = 98^\circ\text{C}$ @ 6 V, 105 mA

Handling Procedures

Please observe the following precautions to avoid damage:

Static Sensitivity

These electronic devices are sensitive to electrostatic discharge (ESD) and can be damaged by static electricity. Proper ESD control techniques should be used when handling these Class 1A, 250 V HBM devices.

PCB Layout

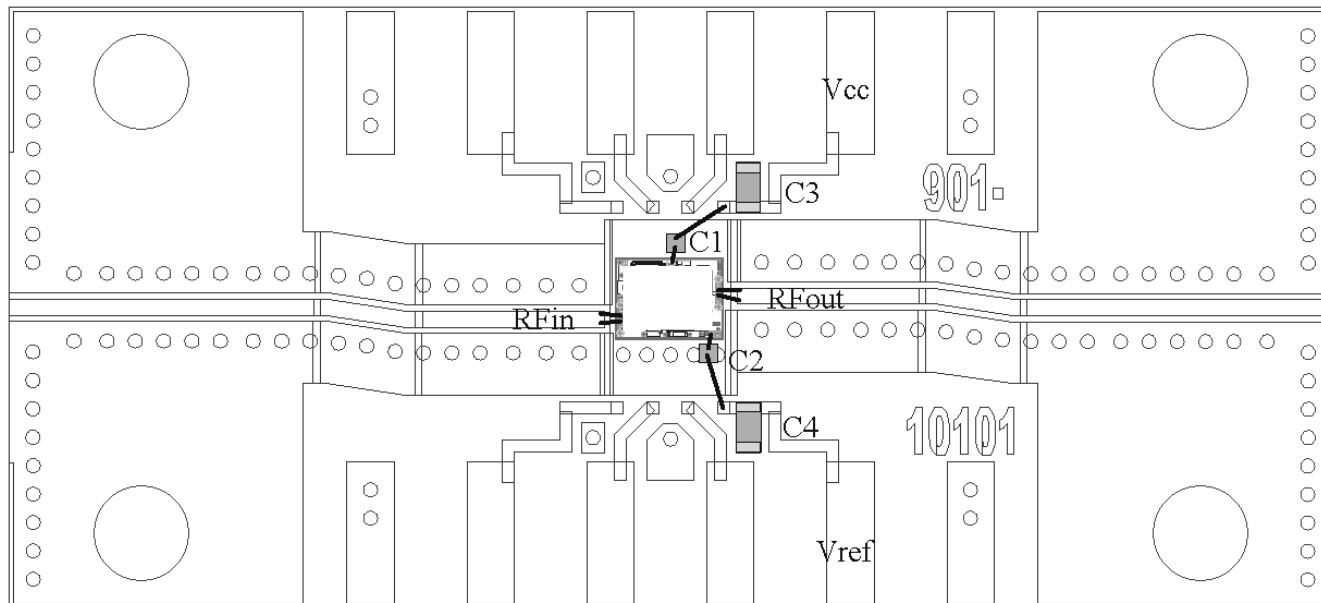

Application Schematic

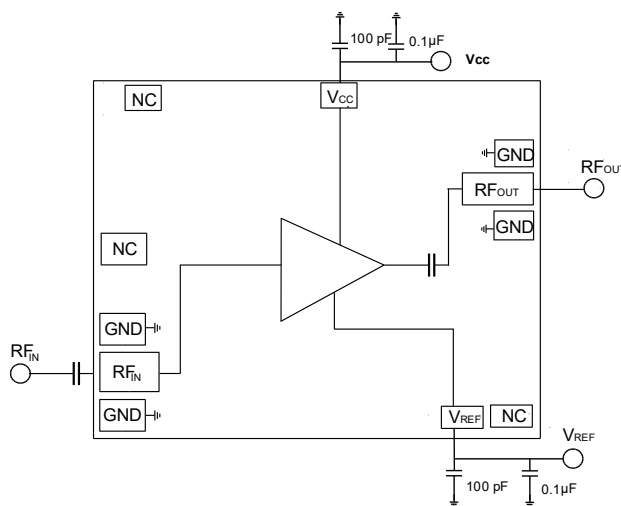

Operation

The technology is HBT; so, the turn-on and turn-off procedure is fairly simple.

To turn-on:

1. Apply +5 V to Vcc
2. Starting at 0 V, adjust V_{REF} for target I_{cc}

To turn-off:

1. Set V_{REF} to 0 V
2. Set Vcc to 0 V

Evaluation PCB Specifications

Top Layer: 1/2 oz Copper Cladding, 0.017 mm thickness
 Dielectric Layer: Rogers RO4003C 0.203 mm thickness
 Bottom Layer: 1/2 oz Copper Cladding, 0.017 mm thickness
 Finished overall thickness: 0.237 mm

Parts List

Part	Value	Case Style	MFG	MFG Part #
C1, C2	100 pF	Single Layer	MACOM	MKVC-050100-1453
C3, C4	0.1 μF	0402	KYOCERA	04023C103KAT2A

Low Phase Noise Amplifier

6 - 12 GHz



MAAL-011155-DIE

Rev. V2

Typical Performance Curves: $V_{CC} = 5\text{ V}$, $I_{CC} = 90\text{ mA}$

Gain

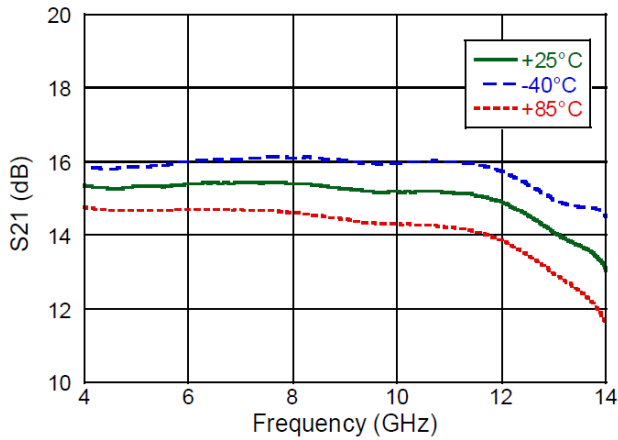

Noise Figure

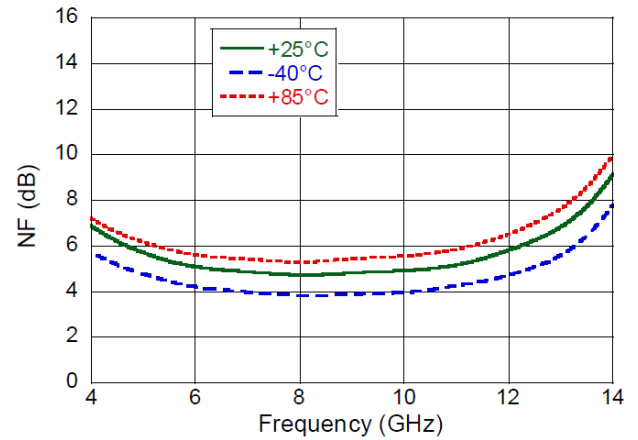

Input Return Loss

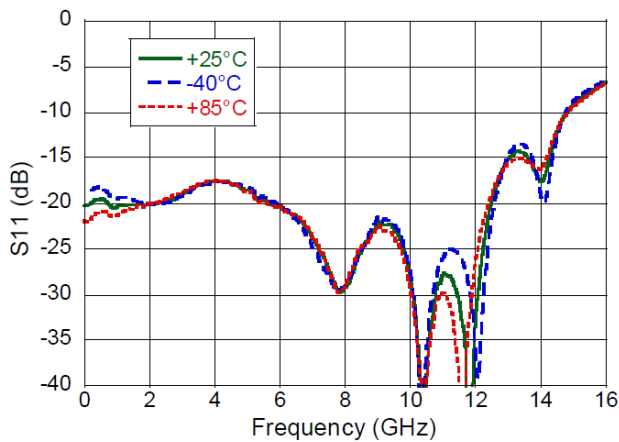

Output Return Loss

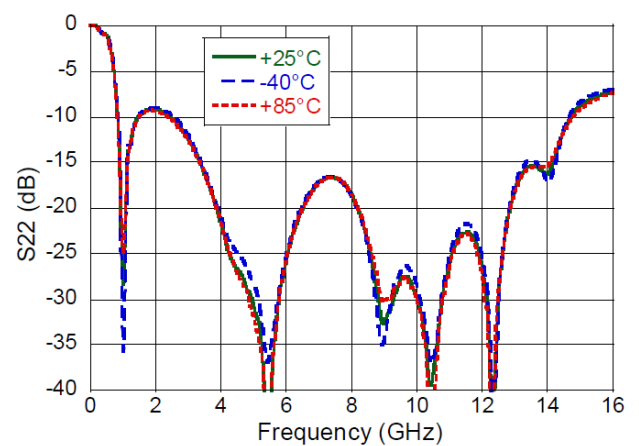

Reverse Isolation

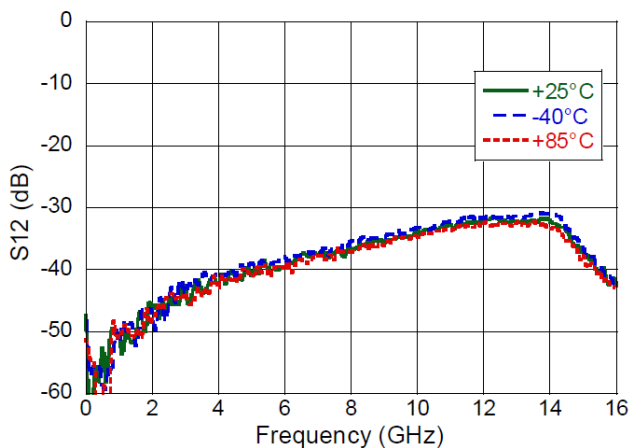

Output IP3

(10 MHz Tone Spacing, $P_{IN} = -10\text{ dBm}$ per tone)

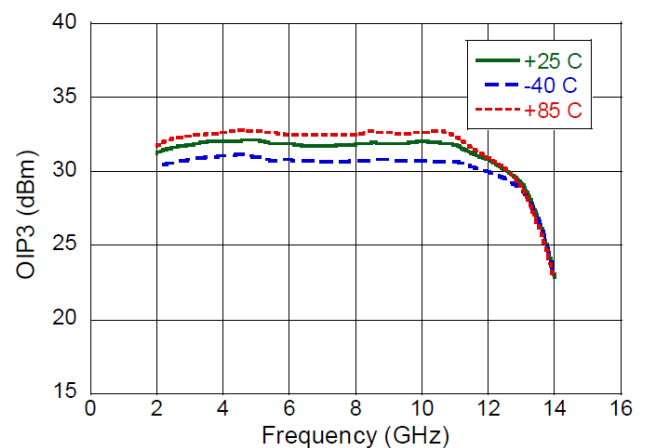

Low Phase Noise Amplifier

6 - 12 GHz



MAAL-011155-DIE

Rev. V2

Typical Performance Curves: $V_{CC} = 5\text{ V}$, $+25^\circ\text{C}$

Gain

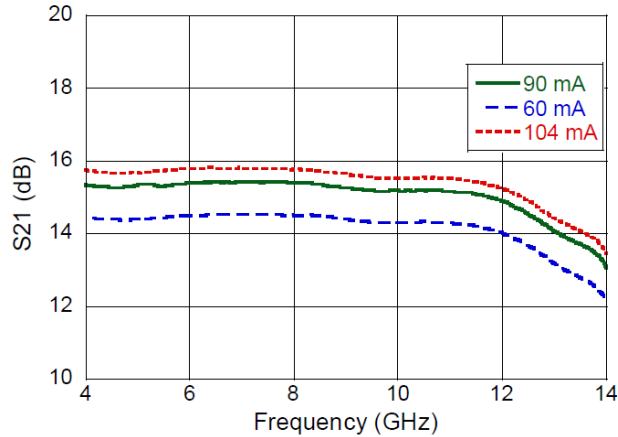

Input Return Loss

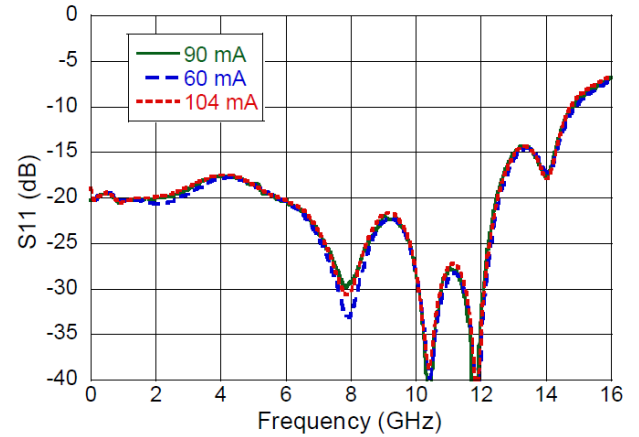

Output Return Loss

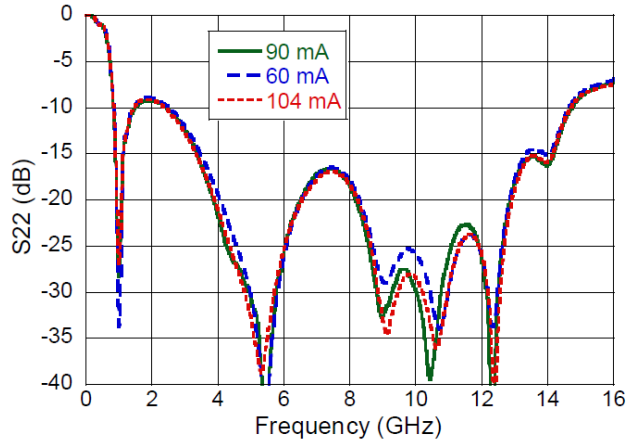

Reverse Isolation

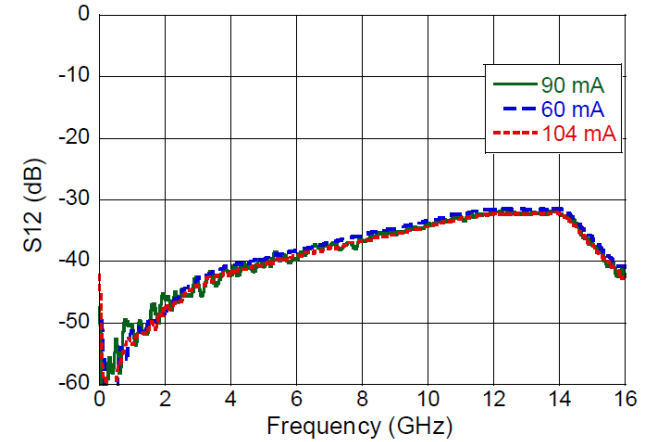

P1dB

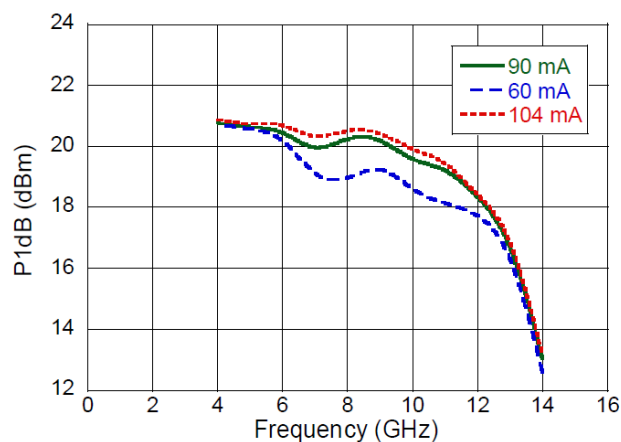

P_{SAT}

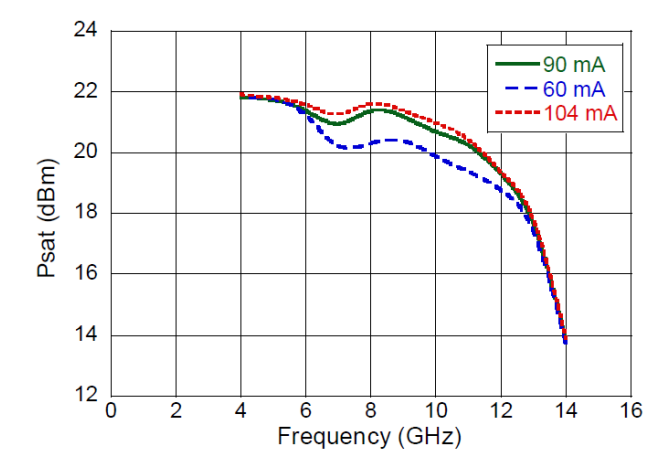

Low Phase Noise Amplifier 6 - 12 GHz



MAAL-011155-DIE

Rev. V2

Typical Performance Curves: $I_{CC} = 90 \text{ mA}$, $+25^\circ\text{C}$

Gain

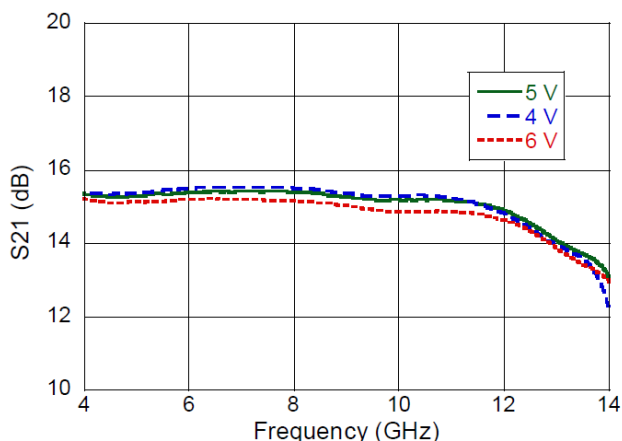

Input Return Loss

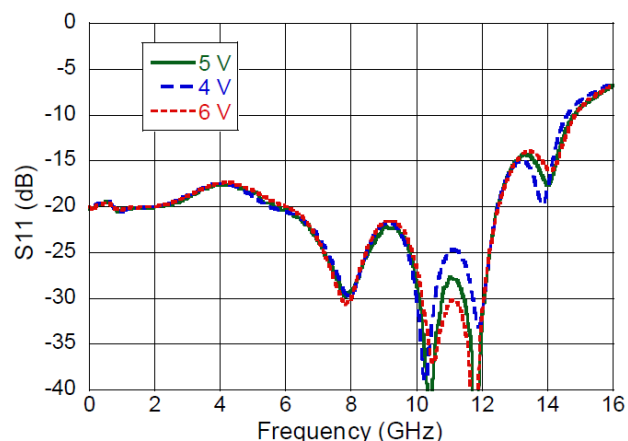

Output Return Loss

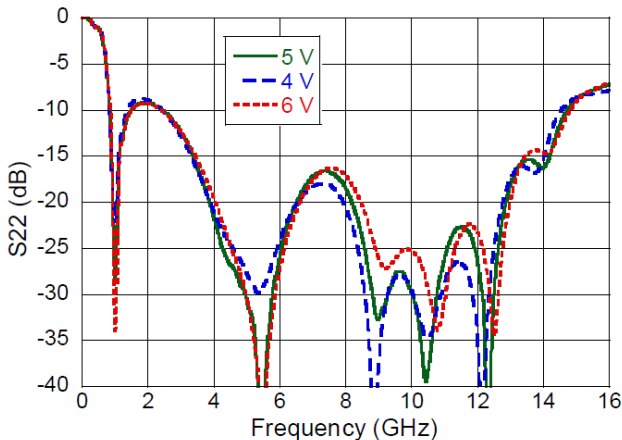

Reverse Isolation

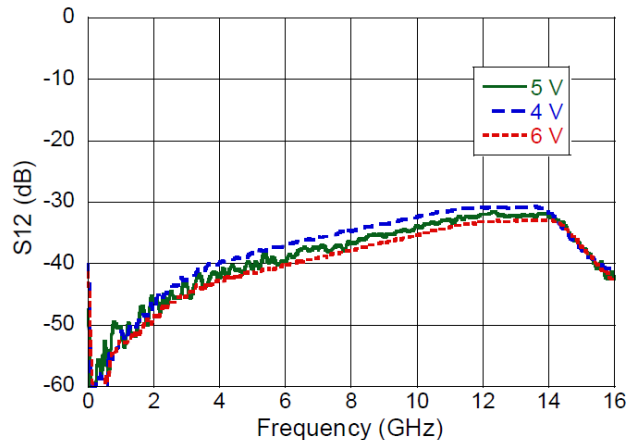

P1dB

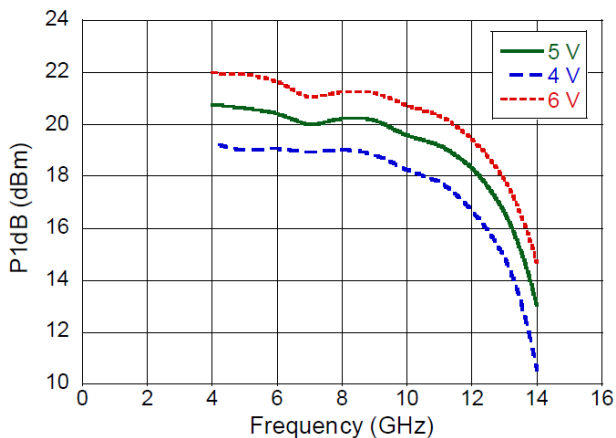

Psat

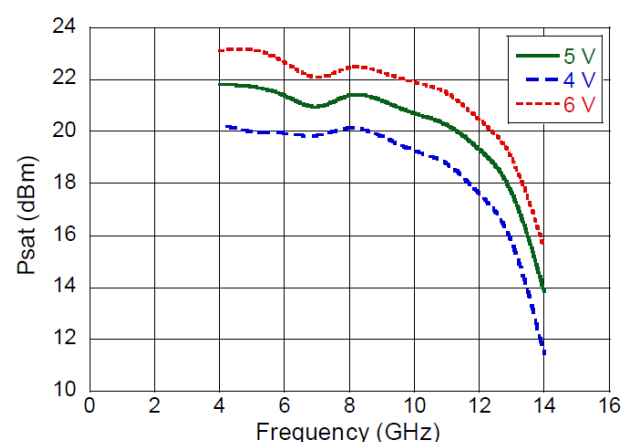

Low Phase Noise Amplifier 6 - 12 GHz



MAAL-011155-DIE

Rev. V2

Typical Performance Curves: +25°C

Noise Figure @ 5 V

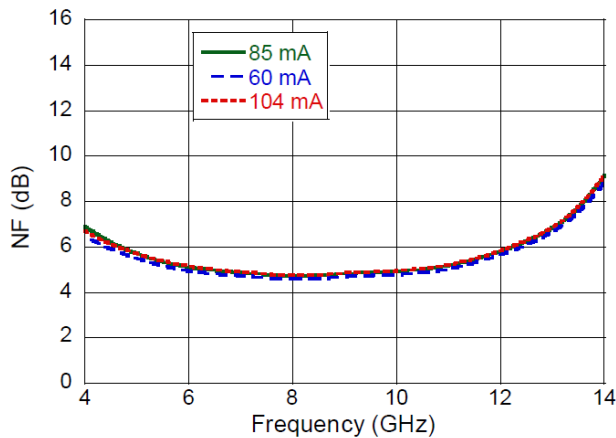

Noise Figure @ 90 mA

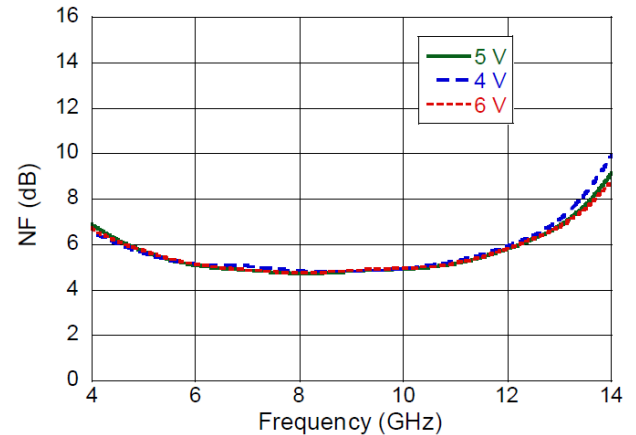

Output IP3 @ 5 V
(10 MHz Tone Spacing, $P_{IN} = -10$ dBm per tone)

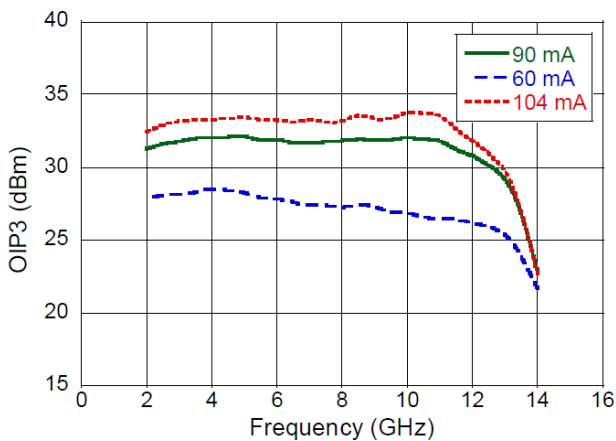

Output IP3 @ 90 mA
(10 MHz Tone Spacing, $P_{IN} = -10$ dBm per tone)

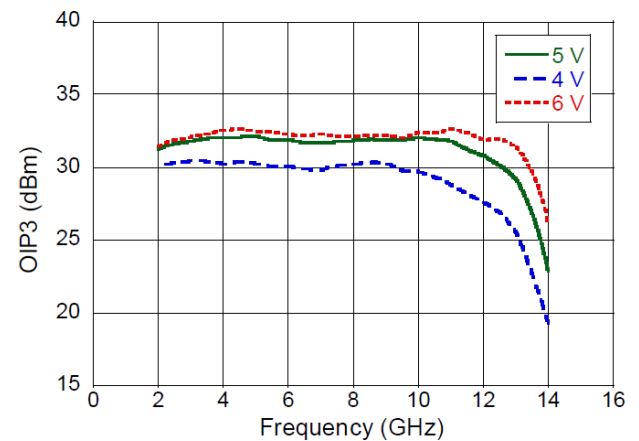

Low Phase Noise Amplifier

6 - 12 GHz



MAAL-011155-DIE

Rev. V2

Typical Performance Curves: $I_{CC} = 90 \text{ mA}$, $+25^\circ\text{C}$

Phase Noise @ 6 GHz, P1dB

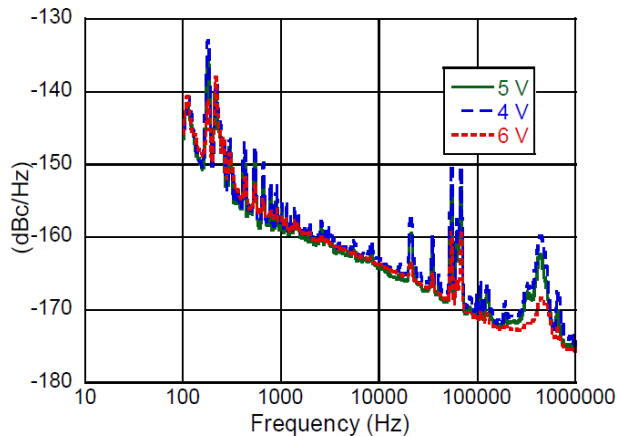

Phase Noise @ 6 GHz, P4dB

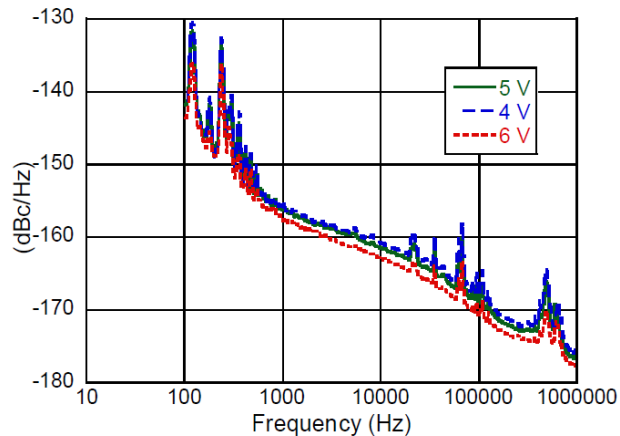

Phase Noise @ 9 GHz, P1dB

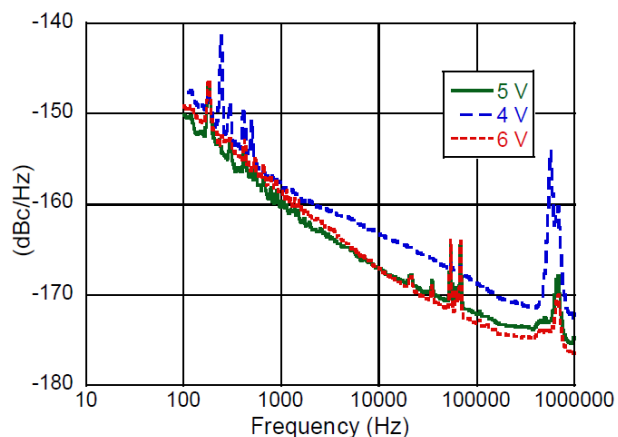

Phase Noise @ 9 GHz, P4dB

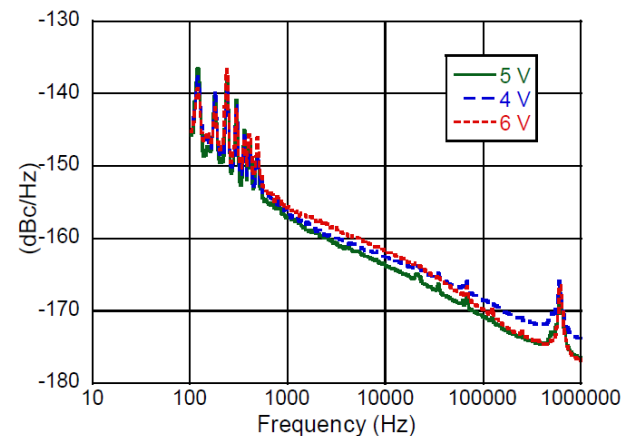

Phase Noise @ 12 GHz, P1dB

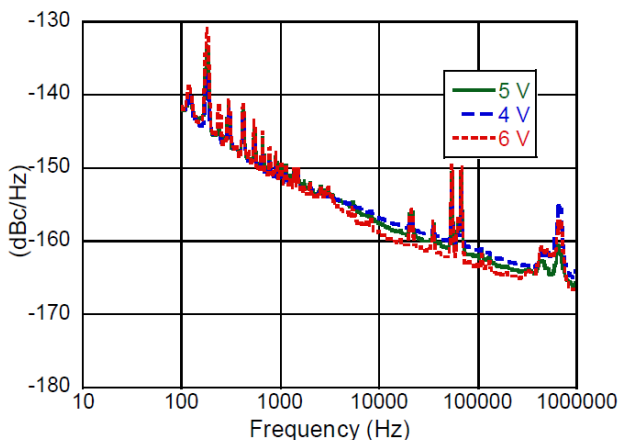

Phase Noise @ 12 GHz, P4dB

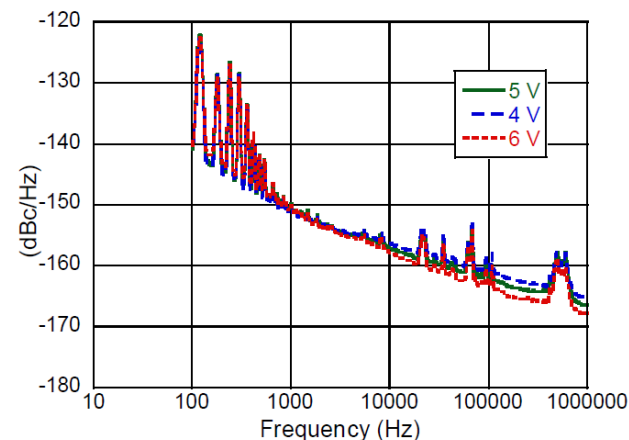

MMIC Die Outline

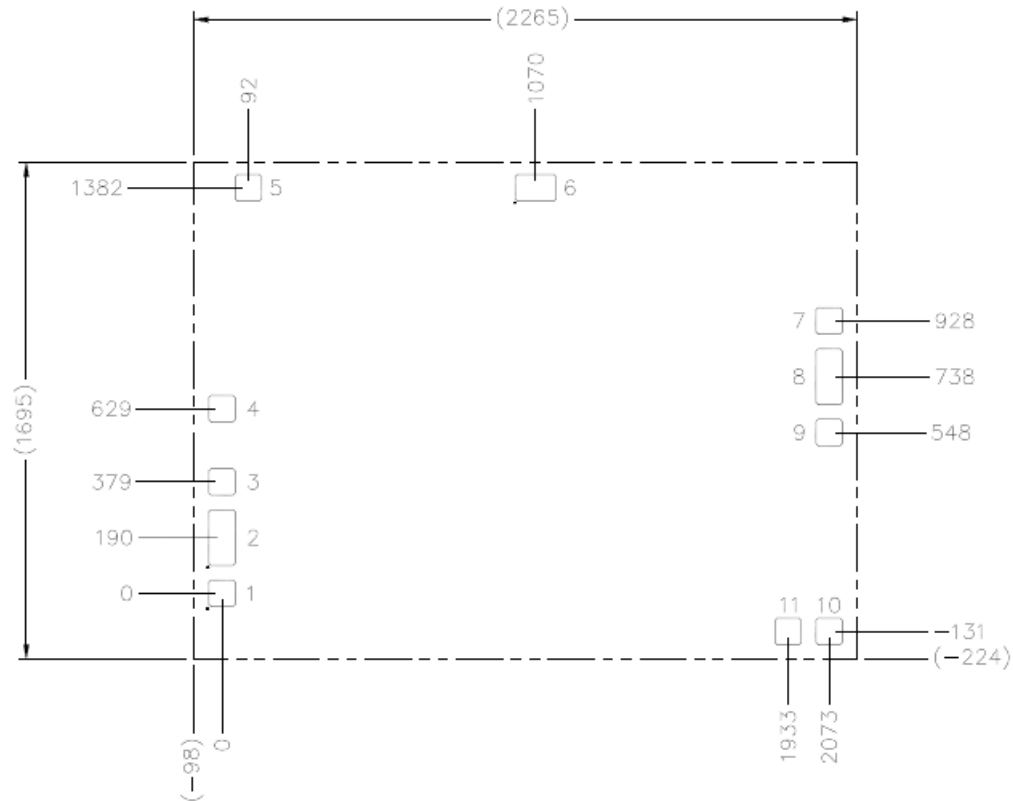

Bond Pad Detail^{6,7,8,9}

Pad #	X	Y
1,3,4,5,7,9,10,11	100	100
2,8	100	200
6	140	100

6. All dimensions shown as microns (μm) with a tolerance of $\pm 5 \mu\text{m}$, unless otherwise noted.
7. Die thickness is $100 \mu\text{m} \pm 10 \mu\text{m}$.
8. Bond pad and backside metallization: gold
9. Die size reflects cut dimensions. Saw or laser kerf reduces die size by $\sim 25 \mu\text{m}$ each dimension.

MACOM Technology Solutions Inc. ("MACOM"). All rights reserved.

These materials are provided in connection with MACOM's products as a service to its customers and may be used for informational purposes only. Except as provided in its Terms and Conditions of Sale or any separate agreement, MACOM assumes no liability or responsibility whatsoever, including for (i) errors or omissions in these materials; (ii) failure to update these materials; or (iii) conflicts or incompatibilities arising from future changes to specifications and product descriptions, which MACOM may make at any time, without notice. These materials grant no license, express or implied, to any intellectual property rights.

THESE MATERIALS ARE PROVIDED "AS IS" WITH NO WARRANTY OR LIABILITY, EXPRESS OR IMPLIED, RELATING TO SALE AND/OR USE OF MACOM PRODUCTS INCLUDING FITNESS FOR A PARTICULAR PURPOSE, MERCHANTABILITY, INFRINGEMENT OF INTELLECTUAL PROPERTY RIGHT, ACCURACY OR COMPLETENESS, OR SPECIAL, INDIRECT, INCIDENTAL, OR CONSEQUENTIAL DAMAGES WHICH MAY RESULT FROM USE OF THESE MATERIALS.

MACOM products are not intended for use in medical, lifesaving or life sustaining applications. MACOM customers using or selling MACOM products for use in such applications do so at their own risk and agree to fully indemnify MACOM for any damages resulting from such improper use or sale.