

## Features

- SOT-25 Low Cost Miniature Plastic Package
- 6.5 dB Typical Conversion Loss
- +3 to +7 dBm LO Drive
- HMIC™ Patented Process
- Silicon Low Barrier Schottky Barrier Diodes
- DC - 400 MHz IF Bandwidth
- RoHS\* Compliant with 260°C Reflow Capability
- 100 % Matte Tin Plating

## Description and Applications

M/A-COM's MA4EX950L1-1225T is a 700-1200 MHz silicon monolithic double balanced mixer in a low cost miniature surface mount SOT-25 package. The die uses M/A-COM's unique HMIC silicon/glass process to realize low loss passive elements while retaining the advantages of medium barrier silicon Schottky barrier diodes.

These mixers are well suited for high volume wireless and cellular applications where small size and repeatability are required. Typical applications include frequency conversion, modulation, and demodulation in wireless receivers and transmitters.

## Ordering Information

Part Number	Package
MA4EX950L1-1225T	Tape and Reel

## SOT-25 Package Outline (Topview)

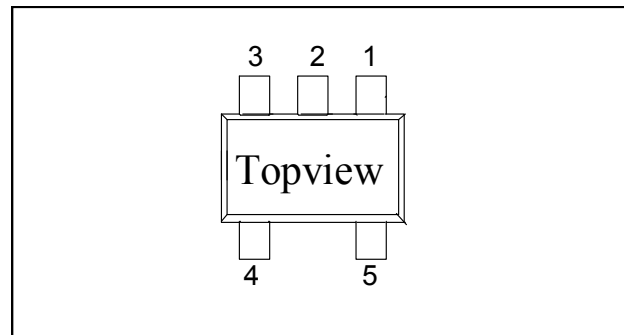

## PIN Configuration

PIN	Function	PIN	Function
1	RF	4	GND
2	GND	5	IF
3	LO	-	-

\* Restrictions on Hazardous Substances, European Union Directive 2005/95/EC.

## Silicon Double Balanced HMIC Mixer 700 - 1200 MHz

Rev. V3

### Electrical Specifications @ +25 °C

Parameter	Frequency Range	Test Conditions	Units	Min.	Typ.	Max.
Conversion Loss	850 MHz 0.7—1.2 GHz	LO Drive = +3 -> + 7dBm RF = -10 dBm, IF = 60 MHz	dB		7.0 8.0	7.5 10.5
L - R Isolation	850 MHz 0.7—1.2 GHz	LO Drive = +5 dBm RF Level = -10 dBm	dB		28.0 25.0	
L - I Isolation	850 MHz 0.7—1.2 GHz	LO Drive = +5 dBm RF Level = -10 dBm	dB		27.0 26.0	
R - I Isolation	850 MHz 0.7—1.2 GHz	LO Drive = +5 dBm RF Level = -10 dBm	dB		28.0 24.0	
LO VSWR	850 MHz 0.7—1.2 GHz	LO Drive = +5 dBm RF Level = -10 dBm			2.4:1 2.8:1	- -
RF VSWR	850 MHz 0.7—1.2 GHz	LO Drive = +15 dBm RF Level = -10 dBm			1.3:1 2.7:1	- -
IF VSWR	DC - 400 MHz	LO Drive = +5 dBm RF Level = -10 dBm			1.4:1	-
Input IP3	850 MHz 0.7—1.2 GHz	LO Drive = +3 -> + 7dBm RF = -10 dBm, IF = 60 MHz	dBm	11.0 9.0	13.2 14.0	
Input 1 dB Compression	850 MHz 0.7—1.2 GHz	LO Drive = +3 -> + 7dBm RF = -10 dBm, IF = 60 MHz	dBm		0 +1.5	
IF 1 dB Bandwidth	DC - 400 MHz	LO = 4650 MHz @ +5 dBm	MHz	0		400.0

# MA4EX950L1-1225T



**Silicon Double Balanced HMIC Mixer**  
**700 - 1200 MHz**

Rev. V3

**Typical Performance Curves (LO Drive = +10 dBm, RF = -10 dBm, IF = 60 MHz)**

**Conversion Loss**

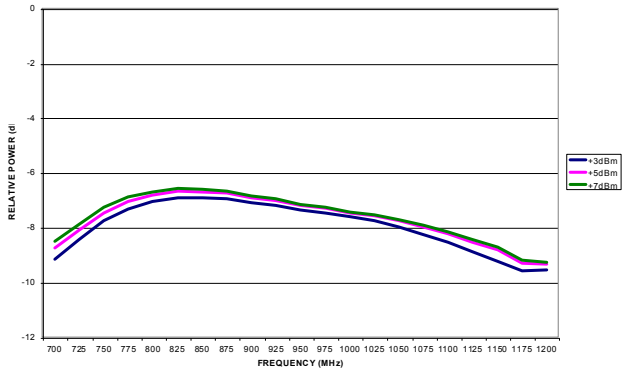

**Isolation**

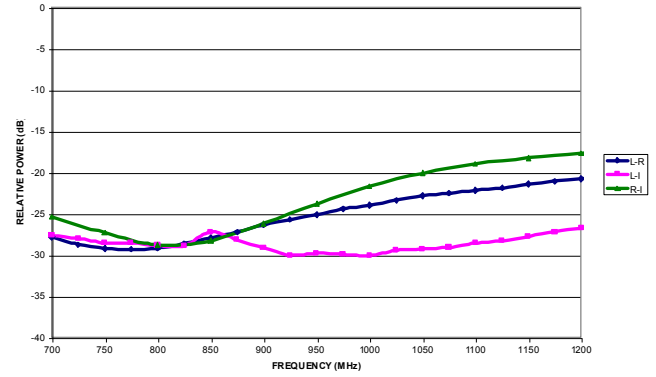

**Typical LO, RF and IF VSWR**

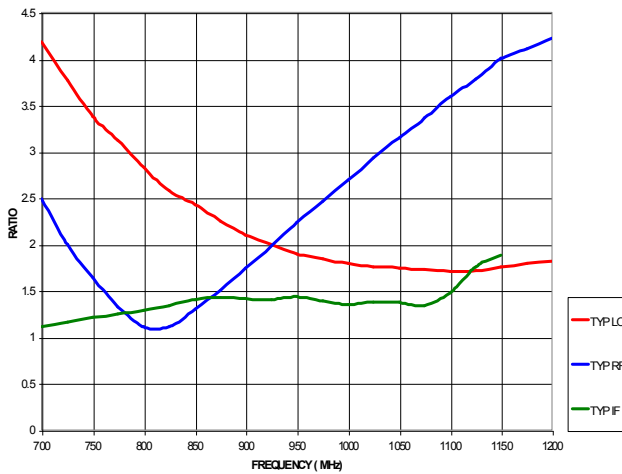

**Third Order Intercept and Input 1 dB Compression Power**

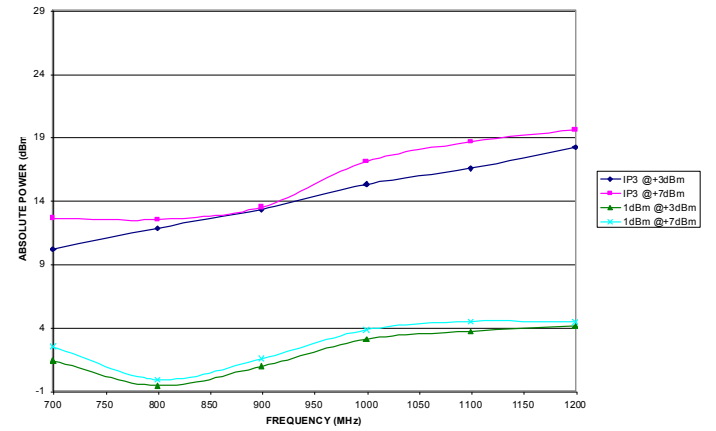

# MA4EX950L1-1225T



**Silicon Double Balanced HMIC Mixer**  
700 - 1200 MHz

Rev. V3

## Case Style SOT-25

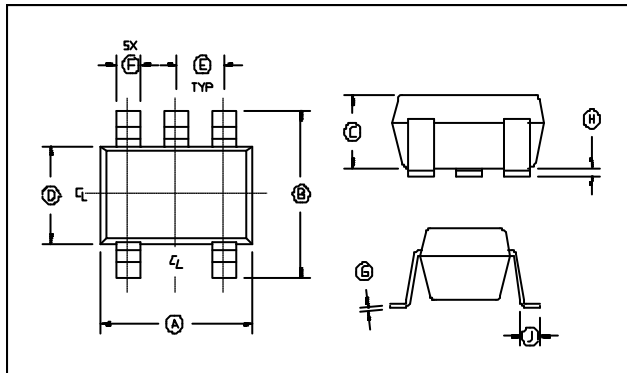

## SOT-25<sup>3,4</sup>

Dim	Inches		Millimeters	
	Min.	Max.	Min.	Max.
A	.1103	.1181	2.80	3.10
B	.1023	.1181	2.6	3.00
C	0.0355	.0512	0.9	1.30
D	0.0591	0.669	1.5	1.70
E	.0374 REF.		.095 REF.	
F	.0138	.0197	.35	.50
G	.0031	0.0079	.08	0.2
H	.0002	.0059	.05	.15
J	0.138	0.216	.35	.55

## Absolute Maximum Ratings<sup>1,2</sup>

Parameter	Maximum Ratings
Operating Temperature	-65 °C to +125 °C
Storage Temperature	-65 °C to +150 °C
Incident LO Power	+20 dBm
Incident RF Power	+20 dBm
Mounting Temperature	+235 °C for 10 seconds
Soldering Temperature	+260 °C max.

1. Exceeding these limits may cause permanent damage.
2. Please refer to application note M538 for surface mounting instructions.

3. Dimensions do not include mold flash, protrusion or gate burrs which shall not exceed 0.0098 in (.25mm) per side.
4. Lead Coplanarity is 0.003 (0.08) max.

## Schematic

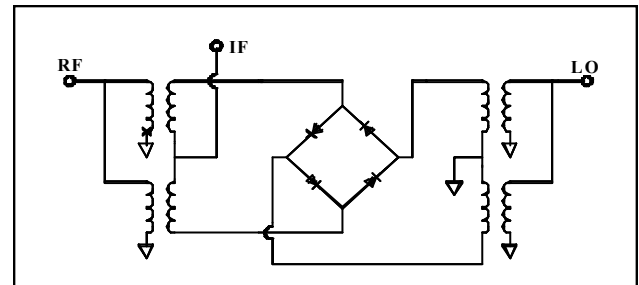

M/A-COM Technology Solutions Inc. All rights reserved.

Information in this document is provided in connection with M/A-COM Technology Solutions Inc ("MACOM") products. These materials are provided by MACOM as a service to its customers and may be used for informational purposes only. Except as provided in MACOM's Terms and Conditions of Sale for such products or in any separate agreement related to this document, MACOM assumes no liability whatsoever. MACOM assumes no responsibility for errors or omissions in these materials. MACOM may make changes to specifications and product descriptions at any time, without notice. MACOM makes no commitment to update the information and shall have no responsibility whatsoever for conflicts or incompatibilities arising from future changes to its specifications and product descriptions. No license, express or implied, by estoppel or otherwise, to any intellectual property rights is granted by this document.

THESE MATERIALS ARE PROVIDED "AS IS" WITHOUT WARRANTY OF ANY KIND, EITHER EXPRESS OR IMPLIED, RELATING TO SALE AND/OR USE OF MACOM PRODUCTS INCLUDING LIABILITY OR WARRANTIES RELATING TO FITNESS FOR A PARTICULAR PURPOSE, CONSEQUENTIAL OR INCIDENTAL DAMAGES, MERCHANTABILITY, OR INFRINGEMENT OF ANY PATENT, COPYRIGHT OR OTHER INTELLECTUAL PROPERTY RIGHT. MACOM FURTHER DOES NOT WARRANT THE ACCURACY OR COMPLETENESS OF THE INFORMATION, TEXT, GRAPHICS OR OTHER ITEMS CONTAINED WITHIN THESE MATERIALS. MACOM SHALL NOT BE LIABLE FOR ANY SPECIAL, INDIRECT, INCIDENTAL, OR CONSEQUENTIAL DAMAGES, INCLUDING WITHOUT LIMITATION, LOST REVENUES OR LOST PROFITS, WHICH MAY RESULT FROM THE USE OF THESE MATERIALS.

MACOM products are not intended for use in medical, lifesaving or life sustaining applications. MACOM customers using or selling MACOM products for use in such applications do so at their own risk and agree to fully indemnify MACOM for any damages resulting from such improper use or sale.