

# GTRA384802FC

Thermally-Enhanced High Power RF GaN on SiC HEMT  
400 W, 48 V, 3600 – 3800 MHz

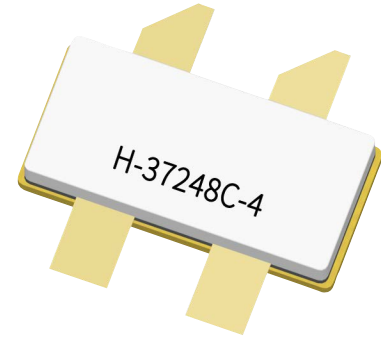

Package Types: H-37248C-4  
PN: GTRA384802FC

## Description

The GTRA384802FC is a 400-watt ( $P_{3dB}$ ) GaN on SiC high electron mobility transistor (HEMT) for use in multi-standard cellular power amplifier applications. It features input and output matching, high efficiency, and a thermally-enhanced package with earless flange.

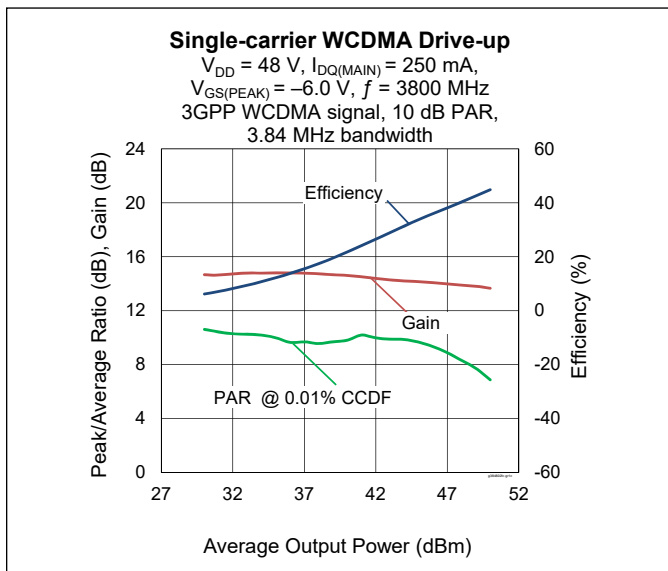

## Features

- GaN on SiC HEMT technology
- Asymmetric Doherty design
  - Main:  $P_{3dB} = 200\text{ W typ}$
  - Peak:  $P_{3dB} = 280\text{ W typ}$
- Typical pulsed CW performance, 3800 MHz, 48 V, combined outputs, Doherty @  $P_{3dB}$ , 10  $\mu\text{s}$ , 10% duty cycle
  - Output power = 400 W
  - Drain efficiency = 62%
  - Gain = 12 dB
- Capable of handling 10:1 VSWR at 48 V, 63 W (WCDMA) output power
- Human Body Model Class 1B (per ANSI/ESDA/ JEDEC JS-001)
- Pb-free and RoHS compliant

## RF Characteristics

### Single-carrier WCDMA Specifications (tested in the Doherty test fixture)

$V_{DD} = 48\text{ V}$ ,  $I_{DQ} = 250\text{ mA}$ ,  $P_{OUT} = 63\text{ W avg}$ ,  $V_{GS(PEAK)} = -6\text{ V}$ ,  $f = 3800\text{ MHz}$ , channel bandwidth = 3.84 MHz, peak/average = 10 dB @ 0.01% CCDF

Characteristic	Symbol	Min.	Typ.	Max.	Unit
Gain	$G_{ps}$	12	13	—	dB
Drain Efficiency	$\eta_D$	38.5	42	—	%
Adjacent Channel Power Ratio	ACPR	—	-33	-29	dBc
Output PAR @ 0.01% CCDF	OPAR	7.3	7.8	—	dB

Note:

All published data at  $T_{CASE} = 25^\circ\text{C}$  unless otherwise indicated

ESD: Electrostatic discharge sensitive device—observe handling precautions!



## DC Characteristics

Characteristic	Symbol	Min.	Typ.	Max.	Unit	Conditions
Drain-source Breakdown Voltage (main)	$V_{BR(DSS)}$	150	—	—	V	$V_{GS} = -8\text{ V}, I_D = 10\text{ mA}$
Drain-source Breakdown Voltage (peak)						
Drain-source Leakage Current	$I_{DSS}$	—	—	5	mA	$V_{GS} = -8\text{ V}, V_{DS} = 10\text{ V}$
Gate Threshold Voltage (main)	$V_{GS(th)}$	-3.8	-3.0	-2.3	V	$V_{DS} = 10\text{ V}, I_D = 25\text{ mA}$
Gate Threshold Voltage (peak)						$V_{DS} = 10\text{ V}, I_D = 36\text{ mA}$

## Recommended Operating Voltages

Parameter	Symbol	Min.	Typ.	Max.	Unit	Conditions
Drain Operating Voltage	$V_{DD}$	0	—	50	V	$V_{DS} = 48\text{ V}, I_D = 250\text{ mA}$
Gate Quiescent Voltage	$V_{GS(Q)}$	-3.9	-2.9	-2.0		

## Absolute Maximum Ratings

Parameter	Symbol	Value	Unit
Drain-source Voltage	$V_{DSS}$	125	V
Gate-source Voltage	$V_{GS}$	-10 to +2	
Operating Voltage	$V_{DD}$	55	
Gate Current (main)	$I_G$	25.2	mA
Gate Current (peak)		36	
Drain Current (main)	$I_D$	9.5	A
Drain Current (peak)		13.5	
Junction Temperature	$T_J$	225	°C
Storage Temperature Range	$T_{STG}$	-65 to +150	

Operation above the maximum values listed here may cause permanent damage. Maximum ratings are absolute ratings; exceeding only one of these values may cause irreversible damage to the component. Exposure to absolute maximum rating conditions for extended periods may affect device reliability. For reliable continuous operation, the device should be operated within the operating voltage range ( $V_{DD}$ ) specified above.

## Thermal Characteristics

Parameter	Symbol	Value	Unit	Conditions
Thermal Resistance (main)	$R_{\theta JC}$	1.6	°C/W	$T_{CASE} = 70^\circ\text{C}, 95\text{ W DC}, 48\text{ V}$
Thermal Resistance (peak)		1.1		$T_{CASE} = 70^\circ\text{C}, 141\text{ W DC}, 48\text{ V}$

## Ordering Information

Type and Version	Order Code	Package Description	Shipping
GTRA384802FC V1 R0	GTRA384802FC-V1-R0	H-37248C-4, earless flange	Tape & Reel, 50 pcs
GTRA384802FC V1 R2	GTRA384802FC-V1-R2	H-37248C-4, earless flange	Tape & Reel, 250 pcs

**Typical Performance** (data taken in a the production test fixture)

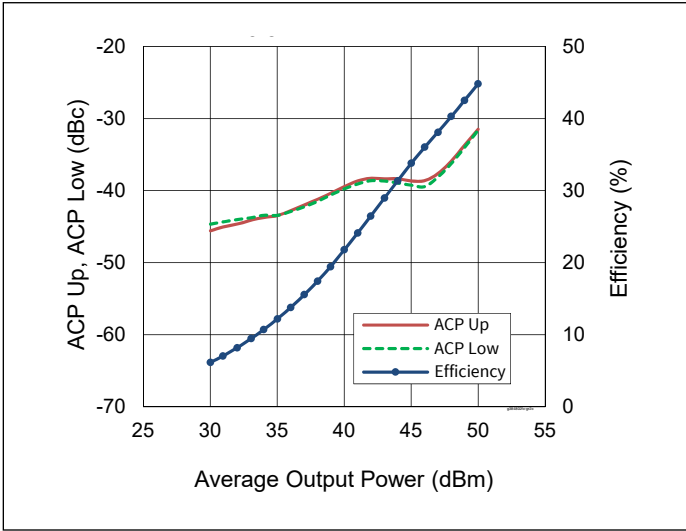

**Figure 1.** Single-carrier WCDMA Drive-up

$V_{DD} = 48\text{ V}$ ,  $I_{DQ(MAIN)} = 250\text{ mA}$ ,  
 $V_{GS(PEAK)} = -6.0\text{ V}$ ,  $f = 3800\text{ MHz}$   
 3GPP WCDMA signal, 10 dB PAR,  
 3.84 MHz bandwidth

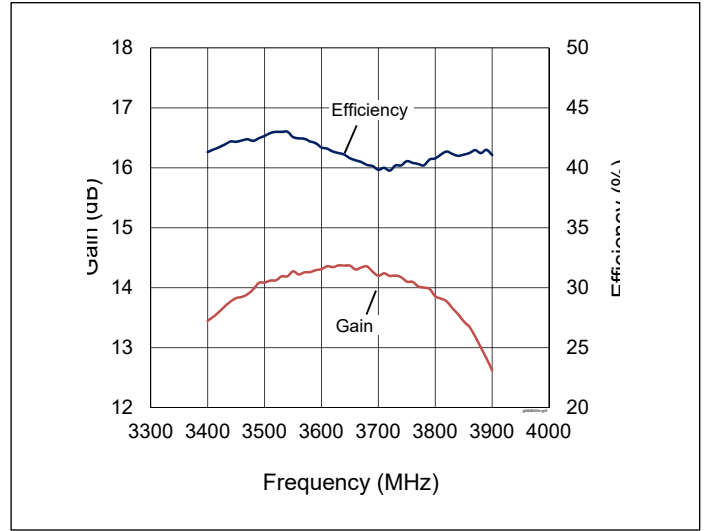

**Figure 2.** Single-carrier WCDMA Broadband

$V_{DD} = 48\text{ V}$ ,  $I_{DQ(MAIN)} = 250\text{ mA}$ ,  
 $V_{GS(PEAK)} = -6.0\text{ V}$ ,  $P_{OUT} = 48\text{ dBm}$   
 3GPP WCDMA signal, 10 dB PAR

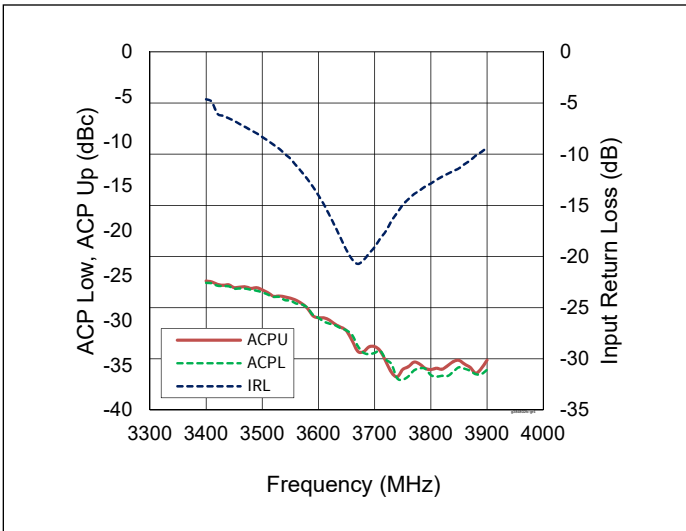

**Figure 3.** Single-carrier WCDMA Broadband

$V_{DD} = 48\text{ V}$ ,  $I_{DQ(MAIN)} = 250\text{ mA}$ ,  
 $V_{GS(PEAK)} = -6.0\text{ V}$ ,  $P_{OUT} = 48\text{ dBm}$   
 3GPP WCDMA signal, 10 dB PAR

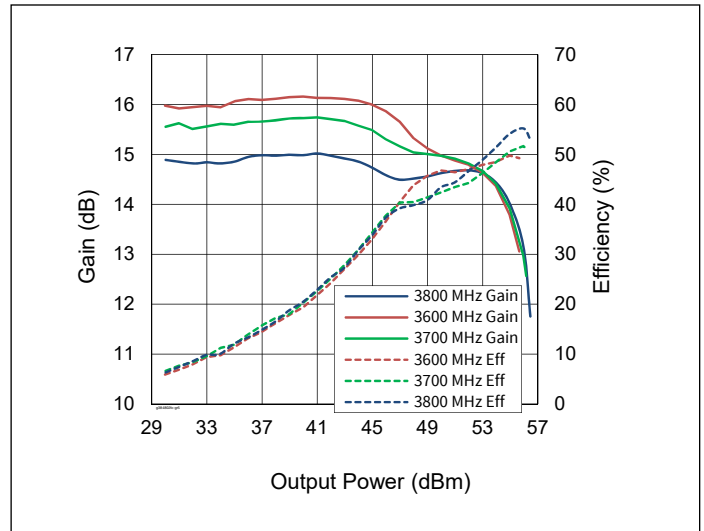

**Figure 4.** CW Performance

$V_{DD} = 48\text{ V}$ ,  $I_{DQ(MAIN)} = 250\text{ mA}$ ,  
 $V_{GS(PEAK)} = -6.0\text{ V}$

**Typical Performance** (cont.)

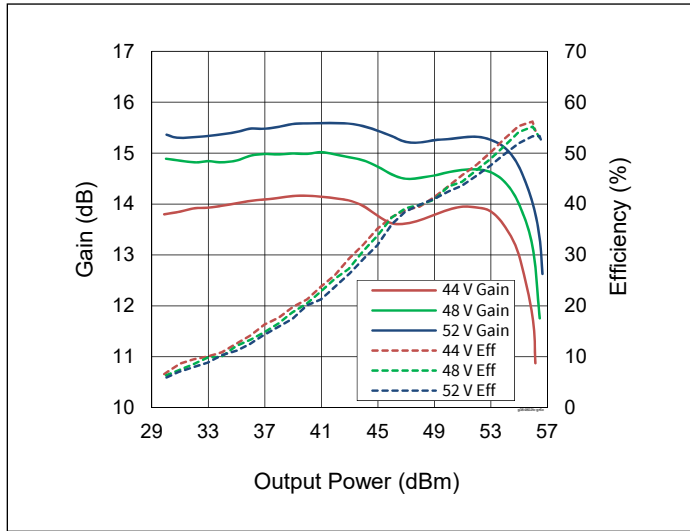

**Figure 5.** CW Performance at various  $V_{DD}$

$I_{DQ(MAIN)} = 250 \text{ mA}$ ,  $V_{GS(PEAK)} = -6.0 \text{ V}$   
 $f = 3800 \text{ MHz}$

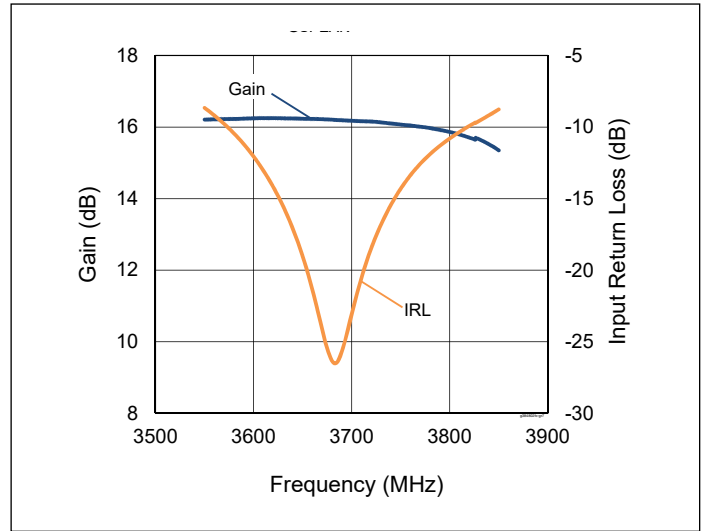

**Figure 6.** Small Signal CW Gain & Input Return Loss

$V_{DD} = 48 \text{ V}$ ,  $I_{DQ(MAIN)} = 250 \text{ mA}$ ,  
 $V_{GS(PEAK)} = -6.0 \text{ V}$

**Load Pull**

**Main side load pull performance** – pulsed CW signal: 10  $\mu\text{sec}$ , 10% duty cycle, 48 V,  $I_{DQ} = 250 \text{ mA}$ , class AB

$P_{3dB}$											
Max Output Power							Max Drain Efficiency				
Freq [MHz]	$Z_s [\Omega]$	$Z_l [\Omega]$	Gain [dB]	$P_{OUT} [\text{dBm}]$	$P_{OUT} [\text{W}]$	Efficiency [%]	$Z_l [\Omega]$	Gain [dB]	$P_{OUT} [\text{dBm}]$	$P_{OUT} [\text{W}]$	Efficiency [%]
3600	11.2 - j7.4	10.2 + j0	18.1	54.70	295	31.3	11.7 - j7	17.0	48.70	74	57.5
3700	6.2 - j5.7	9.5 + j0.9	17.6	54.60	288	31.3	7.5 - j15.6	16.0	48.10	65	57.5
3800	4.0 - j7.3	8.4 + j2	17.4	54.60	288	31.2	16 - j24	14.6	47.20	52	55.5

**Peak side load pull performance** – pulsed CW signal: 10  $\mu\text{sec}$ , 10% duty cycle, 48 V,  $I_{DQ} = 360 \text{ mA}$ , class AB

$P_{3dB}$											
Max Output Power							Max Drain Efficiency				
Freq [MHz]	$Z_s [\Omega]$	$Z_l [\Omega]$	Gain [dB]	$P_{OUT} [\text{dBm}]$	$P_{OUT} [\text{W}]$	Efficiency [%]	$Z_l [\Omega]$	Gain [dB]	$P_{OUT} [\text{dBm}]$	$P_{OUT} [\text{W}]$	Efficiency [%]
3600	15 - j11.4	3 - j8.5	15.4	55.90	389	57.5	1.5 - j7.3	18.5	54.60	288	67.0
3700	10.8 - j8.8	3 - j8.8	14.9	55.60	363	52.2	3 - j7.1	15.7	55.00	316	61.3
3800	6.7 - j8	3 - j8.8	15.2	55.60	363	56.9	1.6 - j7.6	17.0	53.50	224	61.8

**Evaluation Board, 3600 – 3800 MHz**

Evaluation Board Part Number	LTA/GTRA384802FC-V1
PCB Information	Rogers 4350, LoPro®, 0.526mm [0.0207"] thick, 1 oz. copper, $\epsilon_r = 3.55$

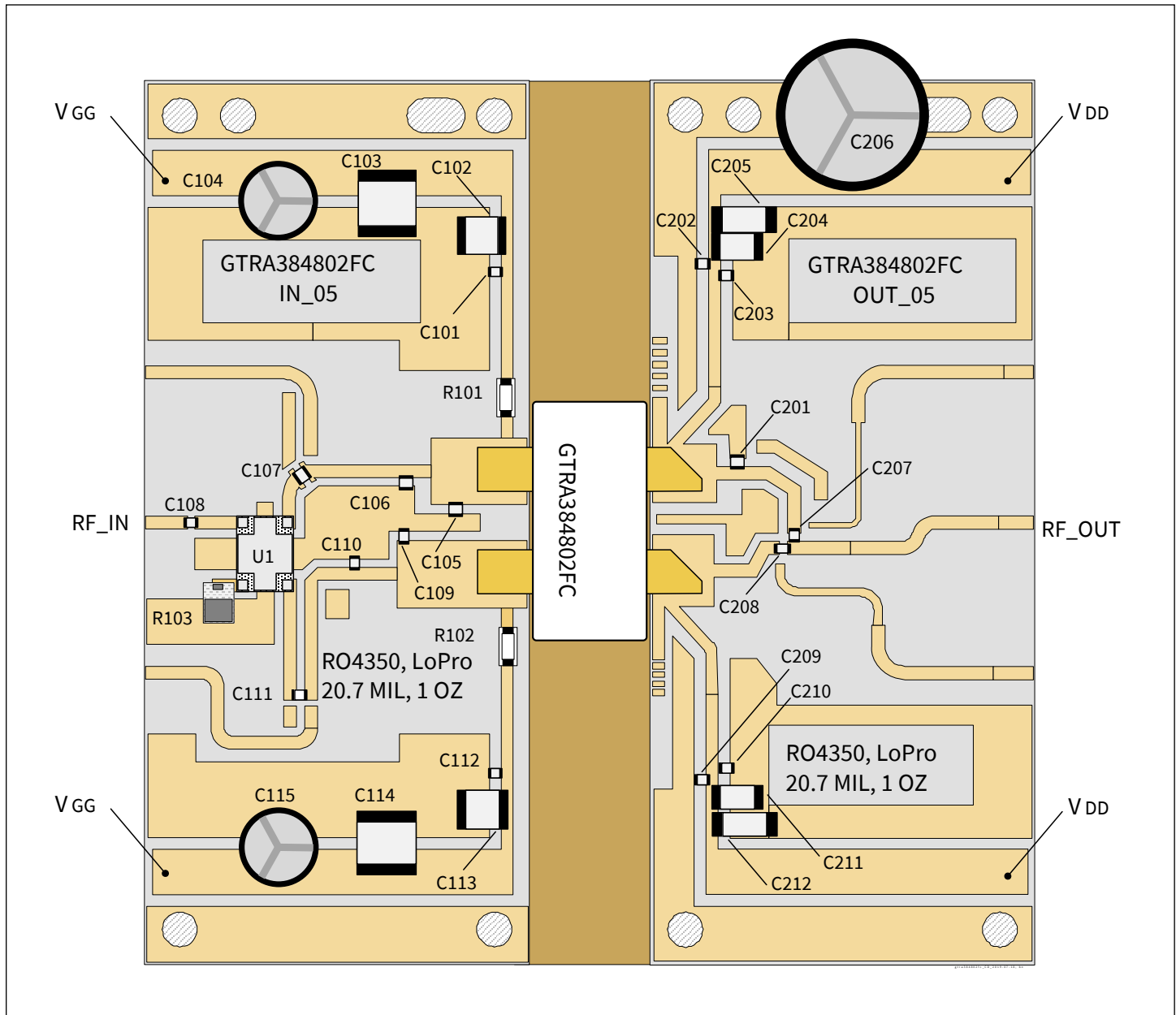

Reference circuit assembly diagram (not to scale)

## Components Information

Component	Description	Manufacturer	P/N
<b>Input</b>			
C101, C107, C108, C111, C112	Capacitor, 10 pF	ATC	ATC800A100JT250XT
C102, C113	Capacitor, 1 $\mu$ F	TDK Corporation	C4532X7R2A105M230KA
C103, C114	Capacitor, 10 $\mu$ F, 100 V	TDK Corporation	C5750X7S2A106M230KB
C104, C115	Capacitor, 100 $\mu$ F, 35 V	Panasonic Electronic Components	EEE-FT1V101AP
C105, C110	Capacitor, 1.2 pF	ATC	ATC800A1R2CT250XT
C106	Capacitor, 1.7 pF	ATC	ATC800A1R7CT250XT
C109	Capacitor, 0.5 pF	ATC	ATC800A0R5CT250XT
R101, R102	Resistor, 5.6 ohms	Panasonic Electronic Components	ERJ-8RQJ5R6V
R103	Resistor, 50 ohms	Anaren	C8A50Z4A
U1	Hybrid coupler	Anaren	XC3500P-03S
<b>Output</b>			
C201	Capacitor, 0.2 pF	ATC	ATC800A0R2CT250XT
C202, C209	Capacitor, 1000 pF, 100 V	Murata Electronics North America	GRM188R72A102KA01D
C203, C207, C208, C210	Capacitor, 10 pF	ATC	ATC800A100JT250XT
C204, C211	Capacitor, 1 $\mu$ F	TDK Corporation	C4532X7R2A105M230KA
C205, C212	Capacitor, 10 $\mu$ F	TDK Corporation	C5750X7S2A106M230KB
C206	Capacitor, 220 $\mu$ F	Panasonic Electronic Components	ECA-2AHG221

## Bias Sequencing

### Bias ON

1. Ensure RF is turned off
2. Apply pinch-off voltage of  $-5\text{ V}$  to the gate
3. Apply nominal drain voltage
4. Bias gate to desired quiescent drain current
5. Apply RF

### Bias OFF

1. Turn RF off
2. Apply pinch-off voltage to the gate
3. Turn-off drain voltage
4. Turn-off gate voltage

## Pinout Diagram (top view)

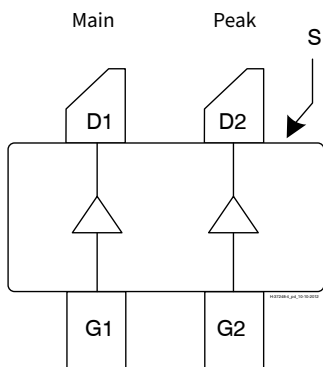

Pin	Description
D1	Drain Device 1 (Main)
D2	Drain Device 2 (Peak)
G1	Gate Device 1 (Main)
G2	Gate Device 2 (Peak)
S	Source (flange)

Lead connections for GTRA384802FC

## Package Outline Specifications – Package H-37248C-4

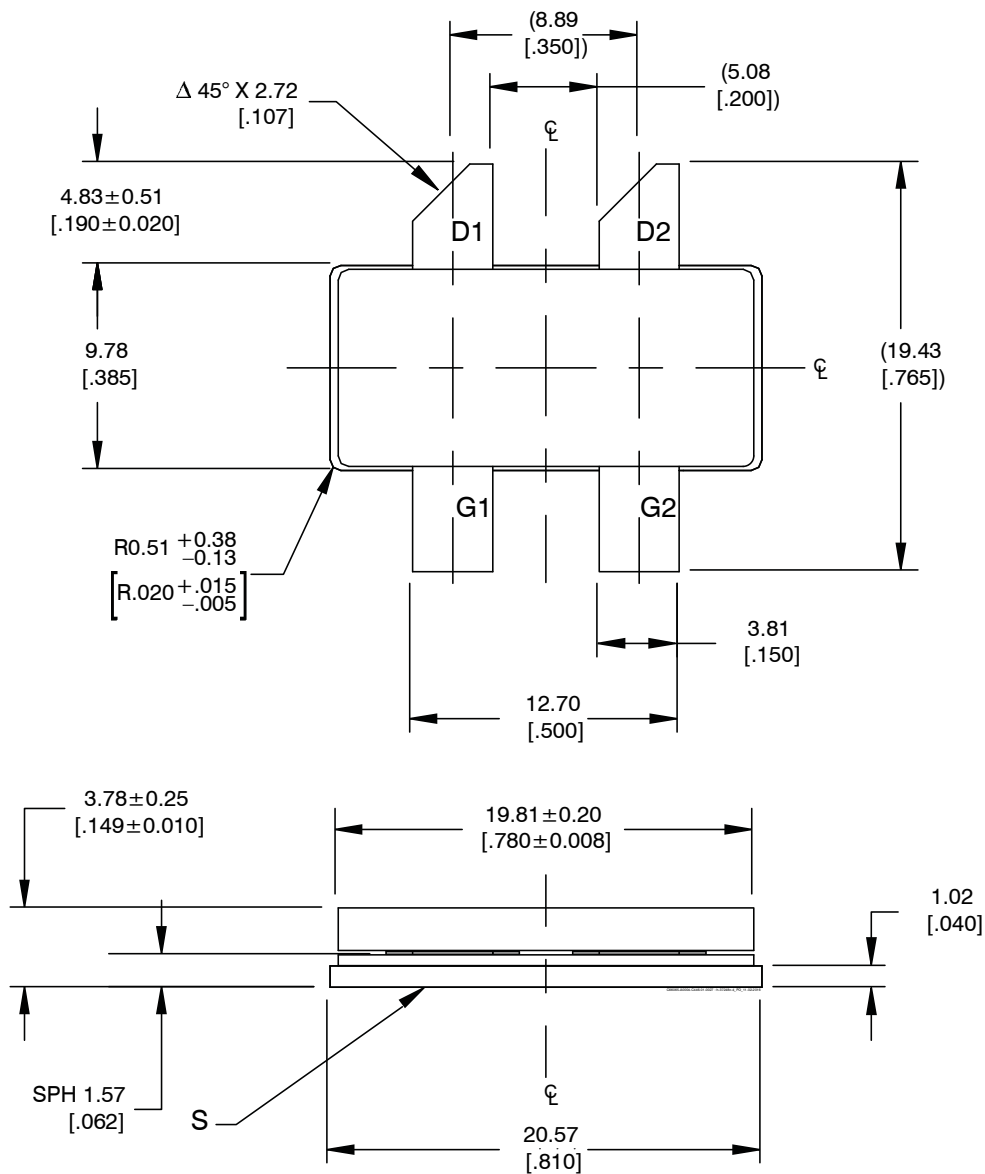

### Diagram Notes—unless otherwise specified:

1. Interpret dimensions and tolerances per ASME Y14.5M-1994
2. Primary dimensions are mm, alternate dimensions are inches
3. All tolerances  $\pm 0.127$  [0.005]
4. Pins: D1, D2 – drain, G1, G2 – gate, S – source (flange)
5. Lead thickness:  $0.13 \pm 0.05$  [0.005  $\pm$  0.002]
6. Gold plating thickness:  $1.14 \pm 0.38$  micron [45  $\pm$  15 microinch]



## Notes & Disclaimer

---

MACOM Technology Solutions Inc. ("MACOM"). All rights reserved.

These materials are provided in connection with MACOM's products as a service to its customers and may be used for informational purposes only. Except as provided in its Terms and Conditions of Sale or any separate agreement, MACOM assumes no liability or responsibility whatsoever, including for (i) errors or omissions in these materials; (ii) failure to update these materials; or (iii) conflicts or incompatibilities arising from future changes to specifications and product descriptions, which MACOM may make at any time, without notice. These materials grant no license, express or implied, to any intellectual property rights.

THESE MATERIALS ARE PROVIDED "AS IS" WITH NO WARRANTY OR LIABILITY, EXPRESS OR IMPLIED, RELATING TO SALE AND/OR USE OF MACOM PRODUCTS INCLUDING FITNESS FOR A PARTICULAR PURPOSE, MERCHANTABILITY, INFRINGEMENT OF INTELLECTUAL PROPERTY RIGHT, ACCURACY OR COMPLETENESS, OR SPECIAL, INDIRECT, INCIDENTAL, OR CONSEQUENTIAL DAMAGES WHICH MAY RESULT FROM USE OF THESE MATERIALS.

MACOM products are not intended for use in medical, lifesaving or life sustaining applications. MACOM customers using or selling MACOM products for use in such applications do so at their own risk and agree to fully indemnify MACOM for any damages resulting from such improper use or sale.