

10 W Solid State Power Amplifier 4 - 6 GHz



ENGAD00074

Rev. V1

Features

- 4 to 6 GHz Band Coverage
- Saturated Output Power: 10 W
- Average PAE @ P_{SAT} : 50%
- Solid State GaN MMIC
- SMA Input/Output Interface
- Single Bias Supply Required
- Size: 1.33" x 1.78" x 0.50"
- RoHS* Compliant

Applications

- Military & Commercial SATCOM
- Electronic Warfare Circuits
- Radar Circuits
- Transmit Circuits
- Telecom Infrastructure
- Test & Measurement Systems

Description

The ENGAD00074 is a packaged Solid State Power Amplifier (SSPA) operating across 4 to 6 GHz with a nominal saturated output power (P_{sat}) of 10 W and average 50% power added efficiency (PAE). The ENGAD00074 uses SMA connectors for the RF input and output ports. RF port impedance is 50 ohms. The ENGAD00074 operates at 26 V drain voltage with a quiescent bias current of 0.47 A.



Ordering Information

Part Number	Package
ENGAD00074	bulk

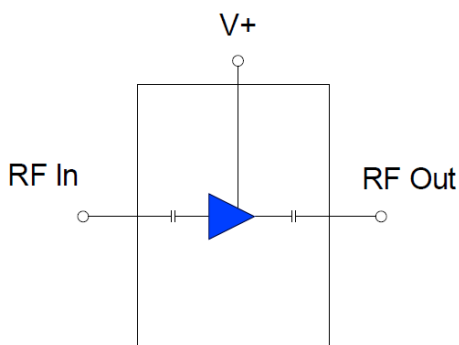

* Restrictions on Hazardous Substances, compliant to current RoHS EU directive.

10 W Solid State Power Amplifier

4 - 6 GHz



ENGAD00074

Rev. V1

Electrical Specifications: Freq. = 4 - 8 GHz, T_A = +25°C, V = 26 V, I_D = 0.9 A, P_{IN} = 16 dBm

Parameter	Test Conditions	Units	Min.	Typ.	Max.
Saturated Power	—	W	8	10	—
PAE @ P _{SAT}	average	%	—	50	—
Small Signal Gain	—	dB	26	28	—
Input Return Loss	—	dB	—	16	—
Output Return Loss	—	dB	—	21	—
DC Current	Small Signal P _{SAT}	A	—	0.47 0.90	—

Recommended Operating Conditions

Parameter	Units	Min.	Typ.	Max.
Voltage	V	18	26	28
CW RF Input Power (for 10 W Output Power)	dBm	—	16	—

Absolute Maximum Ratings^{1,2}

Parameter	Absolute Maximum
Voltage	32 V
RF Input Power	27 dBm
Operating Temperature	-40°C to +85°C
Storage Temperature	-65°C to +125°C

1. Exceeding any one or combination of these limits may cause permanent damage to this device.
2. MACOM does not recommend sustained operation near these survivability limits.

Handling Procedures

Please observe the following precautions to avoid damage:

Static Sensitivity

These electronic devices are sensitive to electrostatic discharge (ESD) and can be damaged by static electricity. Proper ESD control techniques should be used when handling these devices.

10 W Solid State Power Amplifier 4 - 6 GHz



ENGAD00074

Rev. V1

Typical Performance

Saturated Output Power, Efficiency, and DC Current: $T_A = 25^\circ\text{C}$, $V = +26\text{ V}$, $I_d = 0.9\text{ A}$, $P_{IN} = 16\text{ dBm}$

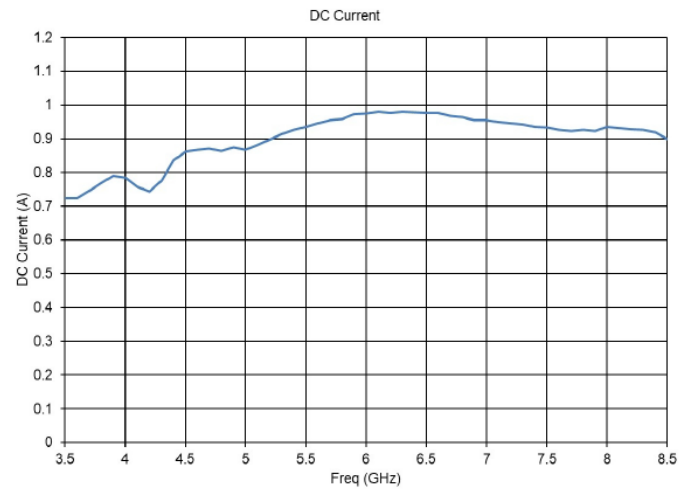
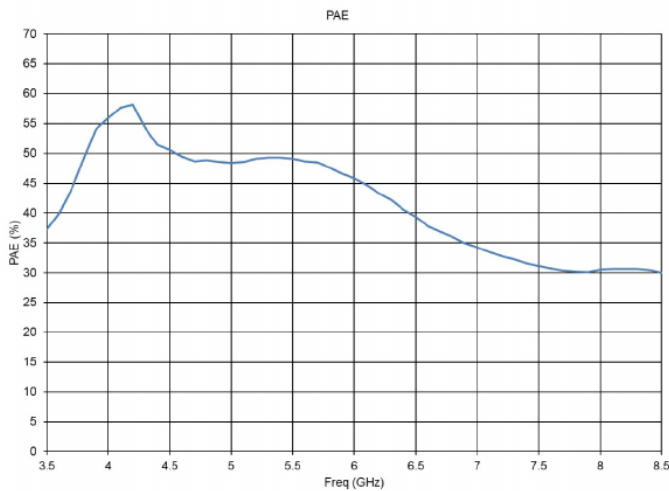
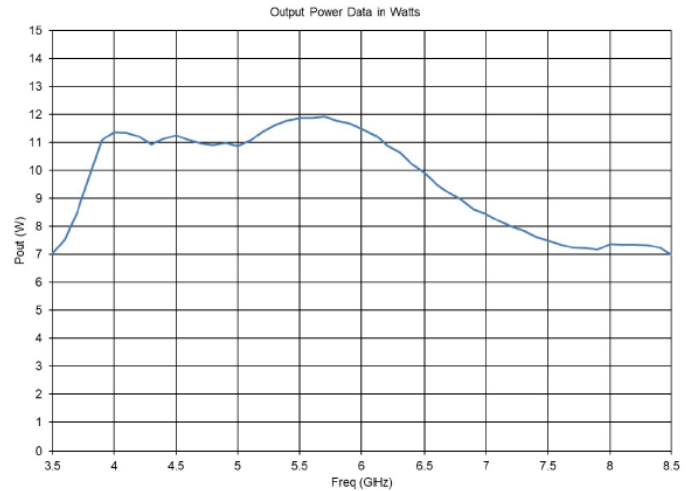
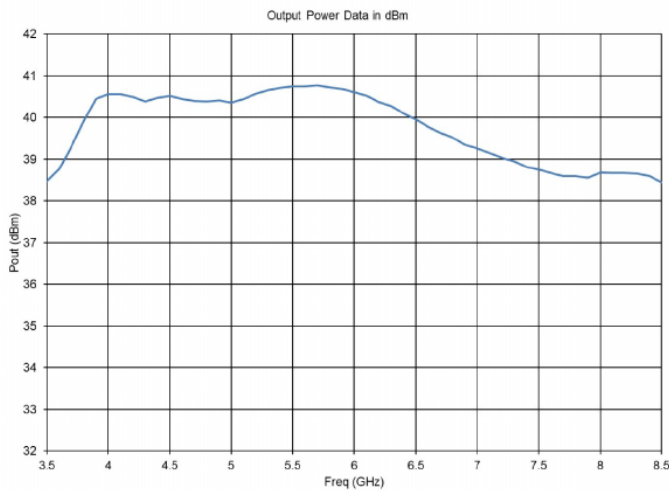

10 W Solid State Power Amplifier 4 - 6 GHz



ENGAD00074

Rev. V1

Typical Performance

Small Signal Gain, Reverse Isolation, and Return Loss: $T_A = 25^\circ\text{C}$, $V = +26\text{ V}$, $I_d = 0.47\text{ A}$, $P_{IN} = -20\text{ dBm}$

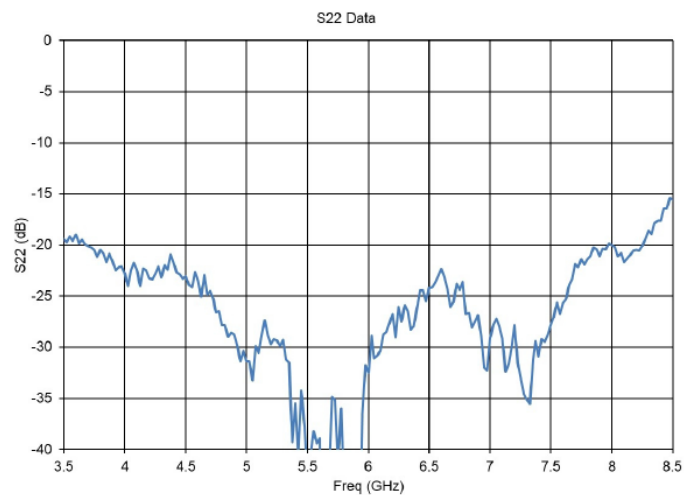
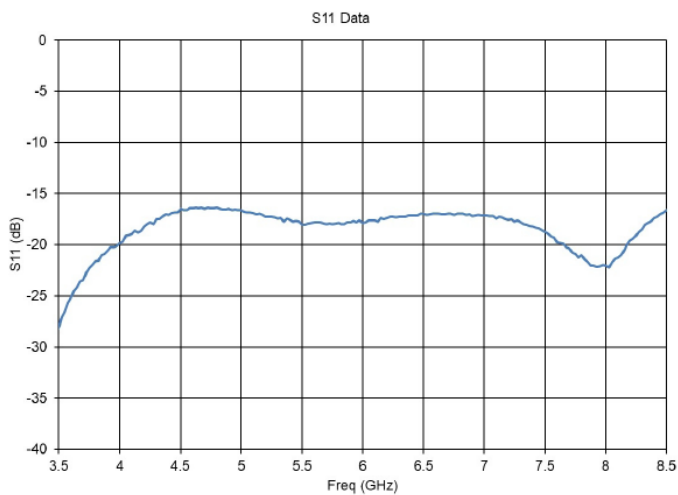
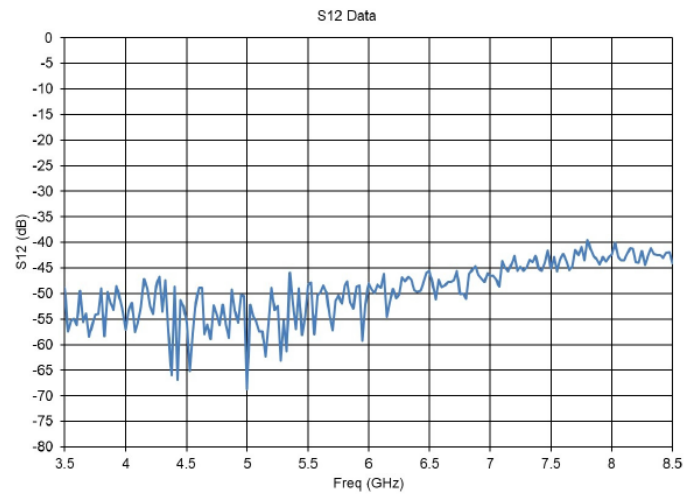
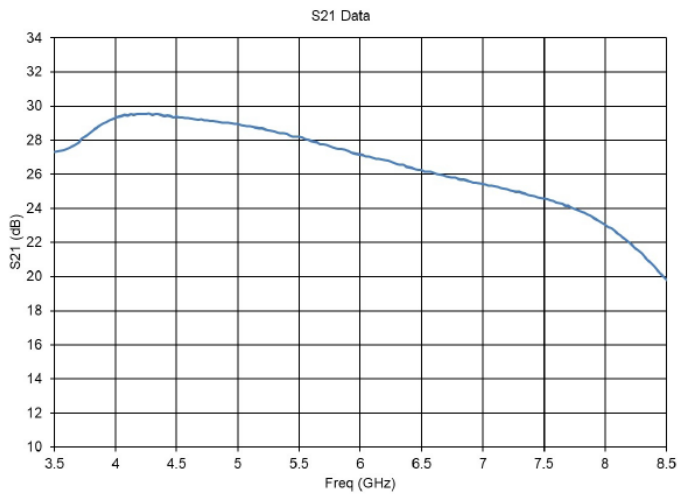

10 W Solid State Power Amplifier 4 - 6 GHz



ENGAD00074

Rev. V1

Outline Drawing

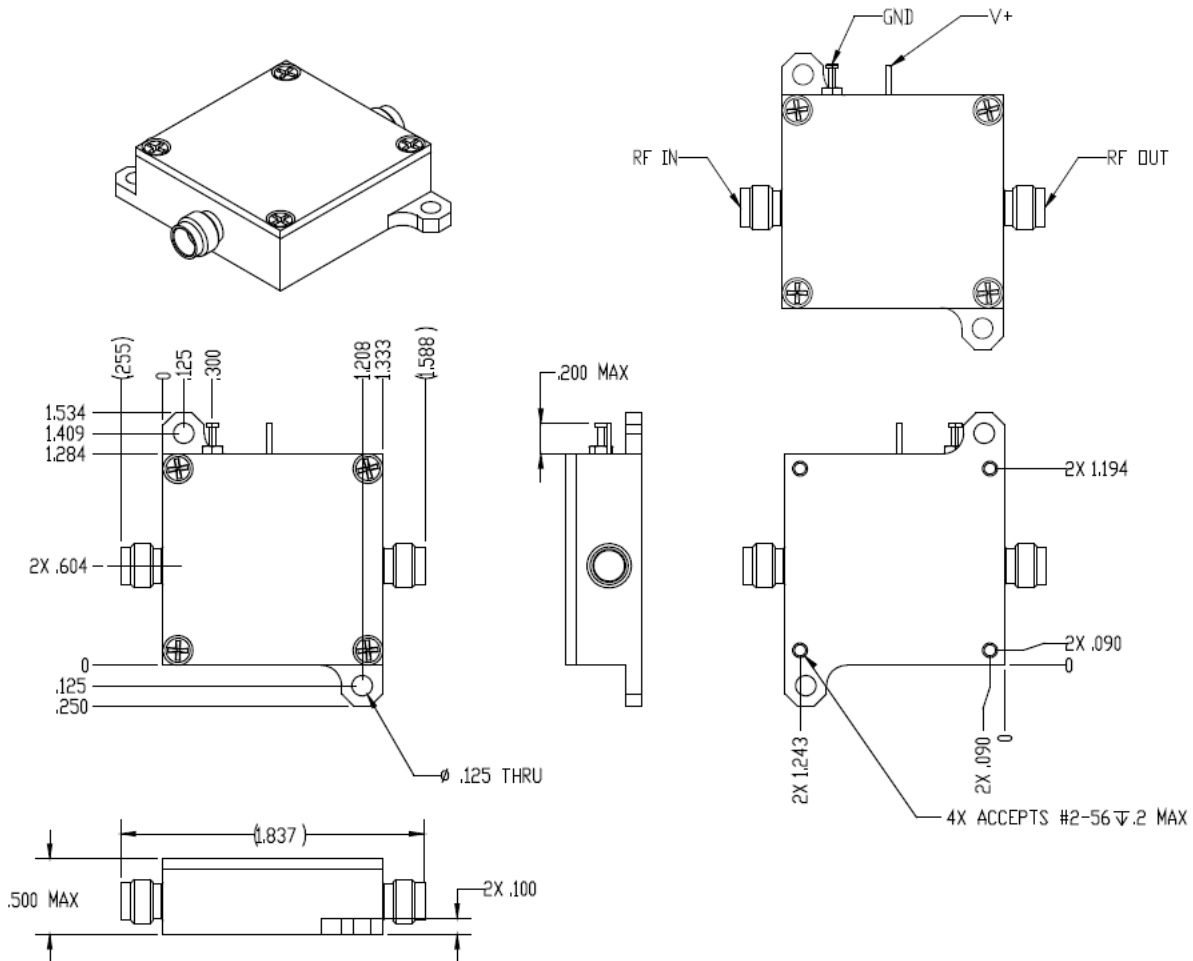

All dimensions are given in inches unless otherwise specified. Typical tolerance: +0.005/-0.005
Mount unit to a low thermal resistance heat sink

10 W Solid State Power Amplifier

4 - 6 GHz



ENGAD00074

Rev. V1

MACOM Technology Solutions Inc. ("MACOM"). All rights reserved.

These materials are provided in connection with MACOM's products as a service to its customers and may be used for informational purposes only. Except as provided in its Terms and Conditions of Sale or any separate agreement, MACOM assumes no liability or responsibility whatsoever, including for (i) errors or omissions in these materials; (ii) failure to update these materials; or (iii) conflicts or incompatibilities arising from future changes to specifications and product descriptions, which MACOM may make at any time, without notice. These materials grant no license, express or implied, to any intellectual property rights.

THESE MATERIALS ARE PROVIDED "AS IS" WITH NO WARRANTY OR LIABILITY, EXPRESS OR IMPLIED, RELATING TO SALE AND/OR USE OF MACOM PRODUCTS INCLUDING FITNESS FOR A PARTICULAR PURPOSE, MERCHANTABILITY, INFRINGEMENT OF INTELLECTUAL PROPERTY RIGHT, ACCURACY OR COMPLETENESS, OR SPECIAL, INDIRECT, INCIDENTAL, OR CONSEQUENTIAL DAMAGES WHICH MAY RESULT FROM USE OF THESE MATERIALS.

MACOM products are not intended for use in medical, lifesaving or life sustaining applications. MACOM customers using or selling MACOM products for use in such applications do so at their own risk and agree to fully indemnify MACOM for any damages resulting from such improper use or sale.