

RF Power MOSFET Transistor 80 W, 2 - 175 MHz, 28 V

Rev. V1

Features

- N-Channel enhancement mode device
- DMOS structure
- Lower capacitances for broadband operation
- High saturated output power
- Lower noise figure than bipolar devices
- RoHS Compliant

ABSOLUTE MAXIMUM RATINGS AT 25° C

Parameter	Symbol	Rating	Units
Drain-Source Voltage	V_{DS}	65	V
Gate-Source Voltage	V_{GS}	20	V
Drain-Source Current	I_{DS}	16	A
Power Dissipation	P_D	206	W
Junction Temperature	T_J	200	°C
Storage Temperature	T_{STG}	-65 to +150	°C
Thermal Resistance	θ_{JC}	0.85	°C/W

TYPICAL DEVICE IMPEDANCE

F (MHz)	Z_{IN} (Ω)	Z_{LOAD} (Ω)
30	5.4 - j4.4	5.7 +j4.7
50	2.5 - j4.4	3.4 + j3.5
100	1.6 - j3.4	2.4 + j2.4
175	0.7 - j1.2	1.7 + j0.8

$V_{DD} = 28V, I_{DQ} = 400mA, P_{OUT} = 80 W$

Z_{IN} is the series equivalent input impedance of the device from gate to source.

Z_{LOAD} is the optimum series equivalent load impedance as measured from drain to ground.

Package Outline

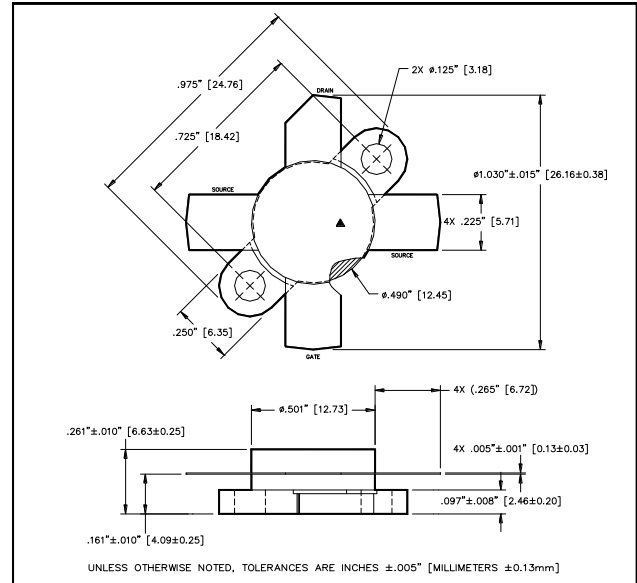

LETTER	MILLIMETERS		INCHES	
	MIN	MAX	MIN	MAX
A	24.64	24.89	.970	.980
B	18.29	18.54	.720	.730
C	25.91	26.42	1.020	1.040
D	12.60	12.85	.496	.506
E	6.22	6.48	.245	.255
F	5.59	5.84	.220	.230
G	3.05	3.30	.120	.130
H	2.21	2.59	.087	.102
J	3.91	4.42	.154	.174
K	6.53	7.34	.257	.289
L	.10	.15	.004	.006

ELECTRICAL CHARACTERISTICS AT 25°C

Parameter	Symbol	Min	Max	Units	Test Conditions
Drain-Source Breakdown Voltage	BV_{DSS}	65	-	V	$V_{GS} = 0.0 V, I_{DS} = 20.0 mA$
Drain-Source Leakage Current	I_{DSS}	-	4.0	mA	$V_{GS} = 28.0 V, V_{DS} = 0.0 V$
Gate-Source Leakage Current	I_{GSS}	-	4.0	μA	$V_{GS} = 20.0 V, V_{DS} = 0.0 V$
Gate Threshold Voltage	$V_{GS(TH)}$	2.0	6.0	V	$V_{DS} = 10.0 V, I_{DS} = 400.0 mA$
Forward Transconductance	G_M	2.0	-	S	$V_{DS} = 10.0 V, I_{DS} = 4.0 A, \Delta V_{GS} = 1.0V, 80 \mu s$ Pulse
Input Capacitance	C_{ISS}	-	180	pF	$V_{DS} = 28.0 V, F = 1.0 MHz$
Output Capacitance	C_{OSS}	-	160	pF	$V_{DS} = 28.0 V, F = 1.0 MHz$
Reverse Capacitance	C_{RSS}	-	32	pF	$V_{DS} = 28.0 V, F = 1.0 MHz$
Power Gain	G_P	13	-	dB	$V_{DD} = 28.0 V, I_{DQ} = 400 mA, P_{OUT} = 80.0 W F = 175 MHz$
Drain Efficiency	η_D	60	-	%	$V_{DD} = 28.0 V, I_{DQ} = 400 mA, P_{OUT} = 80.0 W F = 175 MHz$
Load Mismatch Tolerance	VSWR-T	-	30:1	-	$V_{DD} = 28.0 V, I_{DQ} = 400 mA, P_{OUT} = 80.0 W F = 175 MHz$

Typical Broadband Performance Curves

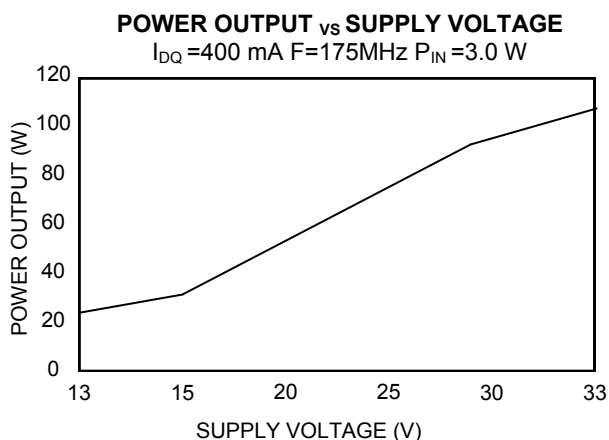
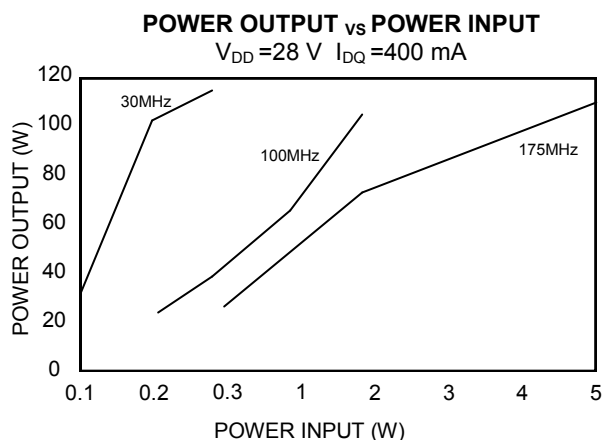
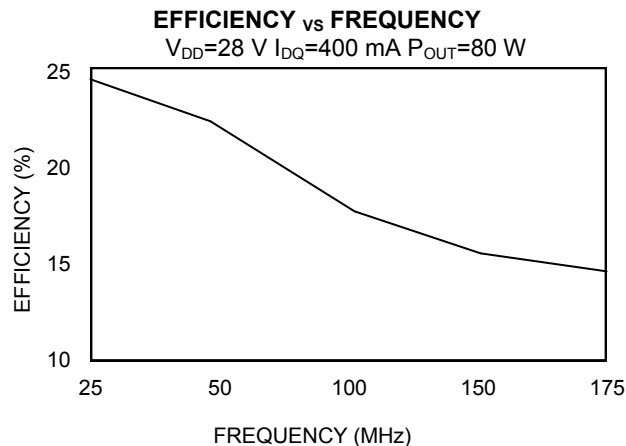
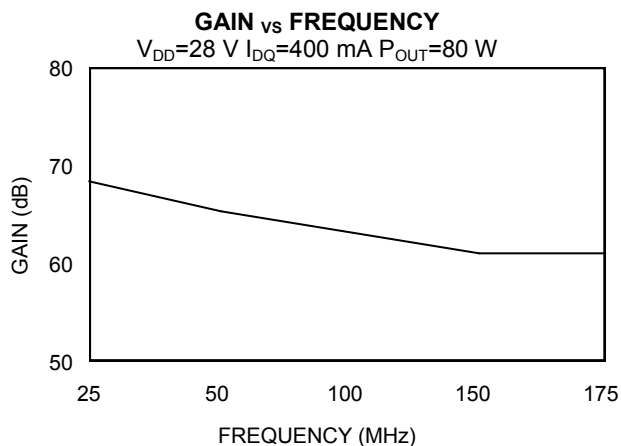

TEST FIXTURE SCHEMATIC

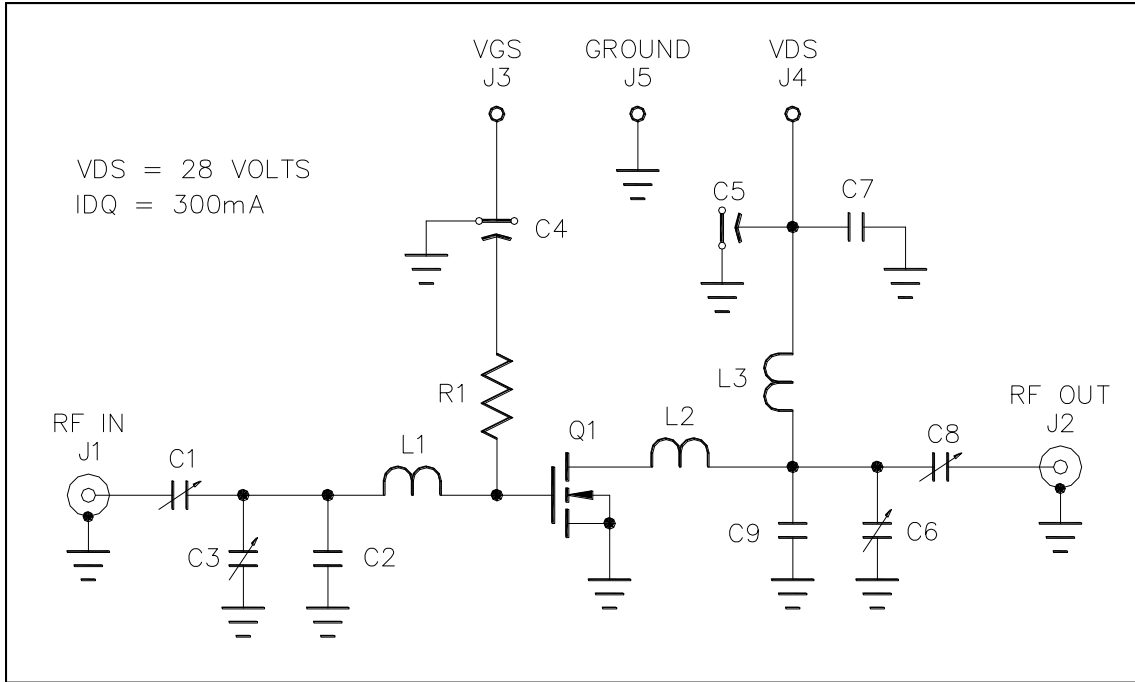

TEST FIXTURE ASSEMBLY

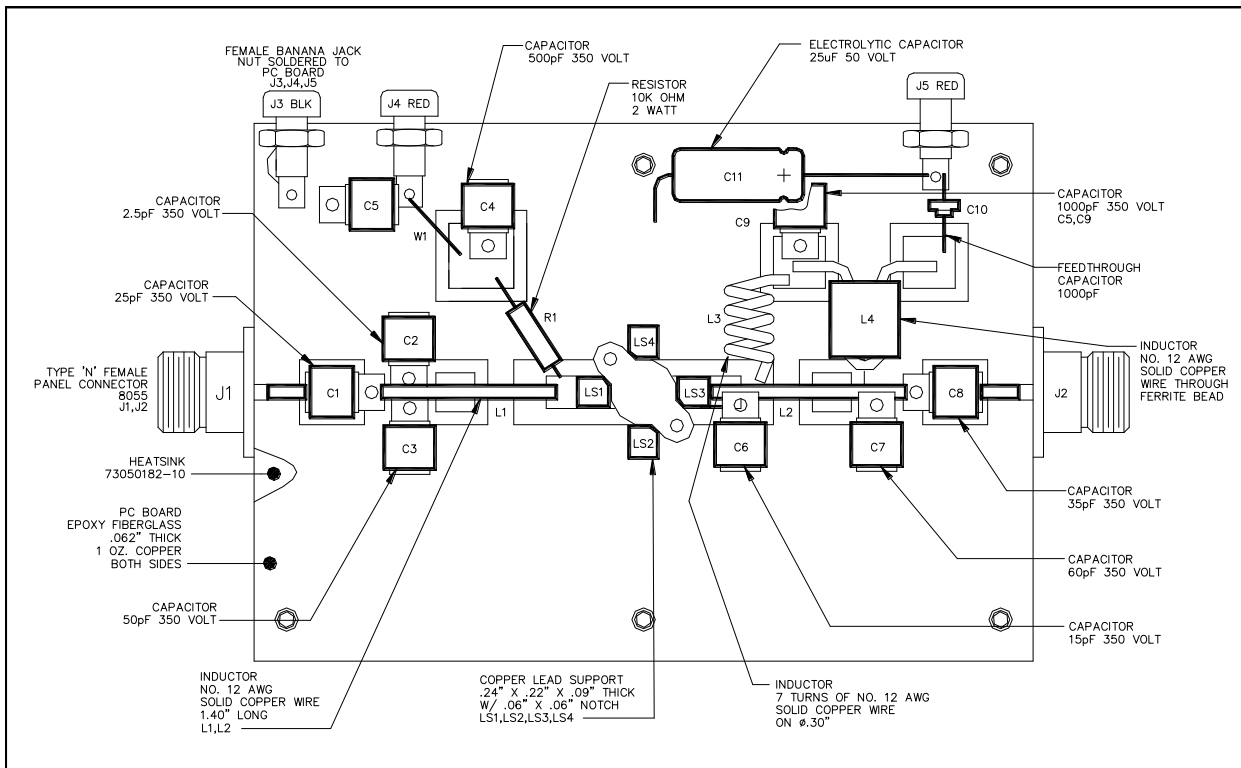

M/A-COM Technology Solutions Inc. All rights reserved.

Information in this document is provided in connection with M/A-COM Technology Solutions Inc ("MACOM") products. These materials are provided by MACOM as a service to its customers and may be used for informational purposes only. Except as provided in MACOM's Terms and Conditions of Sale for such products or in any separate agreement related to this document, MACOM assumes no liability whatsoever. MACOM assumes no responsibility for errors or omissions in these materials. MACOM may make changes to specifications and product descriptions at any time, without notice. MACOM makes no commitment to update the information and shall have no responsibility whatsoever for conflicts or incompatibilities arising from future changes to its specifications and product descriptions. No license, express or implied, by estoppel or otherwise, to any intellectual property rights is granted by this document.

THESE MATERIALS ARE PROVIDED "AS IS" WITHOUT WARRANTY OF ANY KIND, EITHER EXPRESS OR IMPLIED, RELATING TO SALE AND/OR USE OF MACOM PRODUCTS INCLUDING LIABILITY OR WARRANTIES RELATING TO FITNESS FOR A PARTICULAR PURPOSE, CONSEQUENTIAL OR INCIDENTAL DAMAGES, MERCHANTABILITY, OR INFRINGEMENT OF ANY PATENT, COPYRIGHT OR OTHER INTELLECTUAL PROPERTY RIGHT. MACOM FURTHER DOES NOT WARRANT THE ACCURACY OR COMPLETENESS OF THE INFORMATION, TEXT, GRAPHICS OR OTHER ITEMS CONTAINED WITHIN THESE MATERIALS. MACOM SHALL NOT BE LIABLE FOR ANY SPECIAL, INDIRECT, INCIDENTAL, OR CONSEQUENTIAL DAMAGES, INCLUDING WITHOUT LIMITATION, LOST REVENUES OR LOST PROFITS, WHICH MAY RESULT FROM THE USE OF THESE MATERIALS.

MACOM products are not intended for use in medical, lifesaving or life sustaining applications. MACOM customers using or selling MACOM products for use in such applications do so at their own risk and agree to fully indemnify MACOM for any damages resulting from such improper use or sale.