

Features

- 3 Stage Driver Amplifier for 18 & 23 GHz Bands
- Gain: 23 dB
- Output Third Order Intercept (OIP3): 33 dBm
- Output P1dB: 21 dBm
- Noise Figure: 2.8 dB
- Variable Gain with Adjustable Bias
- Lead-Free 4 mm 16-Lead PQFN Package
- RoHS* Compliant

Applications

- Aerospace & Defense
- Point-to-Point
- Cellular Backhaul

Description

The MAAM-011132 is a packaged driver amplifier that operates from 16.4 - 23.6 GHz. The amplifier provides 23 dB small signal gain. The input and output are internally matched to 50 Ω with on-chip DC blocking capacitors. The 33 dBm output third order intercept point (OIP3) and 21 dBm output P1dB provide excellent linearity for transmit lineups.

The packaged amplifier comes in an industry standard lead free 4 mm QFN package. The device includes on-chip ESD protection structures and DC by-pass capacitors to ease the implementation and volume assembly of the packaged part.

The device is specifically designed for use in 18 and 23 GHz point-to-point radios for cellular backhaul applications.

Ordering Information¹

Part Number	Package
MAAM-011132-TR0500	500 Piece Reel
MAAM-011132-TR1000	1000 Piece Reel
MAAM-011132-000SMB	Sample Board

1. Reference Application Note M513 for reel size information.

Functional Schematic

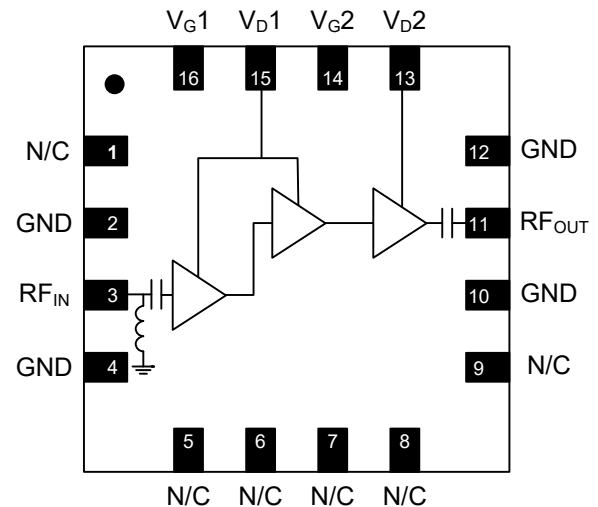

Pin Configuration²

Pin #	Function
1, 5 - 9	No Connection
2, 4, 10, 12	Ground
3	RF Input
11	RF Output
13	V _{D2}
14	V _{G2}
15	V _{D1}
16	V _{G1}
17	Paddle ³

2. For optimum RF performance, all N/Cs should be terminated to ground.

3. The exposed pad centered on the package bottom must be connected to RF and DC ground.

* Restrictions on Hazardous Substances, compliant to current RoHS EU directive.

Electrical Specifications⁴: $V_D = 4\text{ V}$, $I_{D1} = 90\text{ mA}$, $I_{D2} = 90\text{ mA}$, $T_A = +25^\circ\text{C}$

Parameter	Test Condition	Units	Min.	Typ.	Max.
Frequency Range (LO)	—	GHz	16.4	—	23.6
Gain	17.7 - 23.6 GHz 16.4 GHz	dB	20 —	23 20	—
Input Return Loss	17.7 - 23.6 GHz	dB	—	12	—
Output Return Loss	17.7 - 23.6 GHz	dB	—	12	—
Noise Figure	17.7 - 23.6 GHz	dB	—	2.8	—
Output P1dB	17.7 - 23.6 GHz 16.4 GHz	dBm	—	21 20	—
Output IP3	17.7 - 23.6 GHz	dBm	—	33	—

4. Apply gate voltages prior to drain voltages. Adjust V_{G1} and V_{G2} between -1.0 and -0.1 V to achieve specified drain current. Typical current, 180 mA = 90 (I_{D1}) + 90 (I_{D2}).

Absolute Maximum Ratings^{5,6,7}

Parameter	Absolute Maximum
Drain Voltage	4.3 V
Drain Current per Stage	133 mA
Gate Bias Voltage ($V_{G1,2}$)	-1.5 V < V_G < 0 V
Input Power	3 dBm
Junction Temperature	+150°C
Operating Temperature	-40°C to +85°C
Storage Temperature	-55°C to +150°C

- Exceeding any one or combination of these limits may cause permanent damage to this device.
- MACOM does not recommend sustained operation near these survivability limits.
- Operating at nominal conditions with $T_J \leq +150^\circ\text{C}$ will ensure $\text{MTTF} > 1 \times 10^6$ hours. Channel temperature directly affects device MTTF. Channel temperature should be kept as low as possible to maximize lifetime. Thermal resistance, θ_{JC} , is 62.5°C/W.

Handling Procedures

Please observe the following precautions to avoid damage:

Static Sensitivity

Gallium Arsenide Integrated Circuits are sensitive to electrostatic discharge (ESD) and can be damaged by static electricity. Proper ESD control techniques should be used when handling these HBM Class 1B devices.

Typical Performance Curves: $V_{D1,2} = 4\text{ V}$, $I_{D1} = I_{D2} = 90\text{ mA}$

S-Parameters vs. Frequency

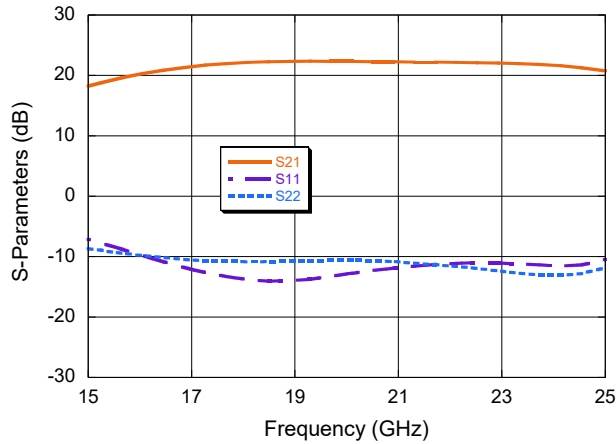

Output / Input IP3 vs. Frequency

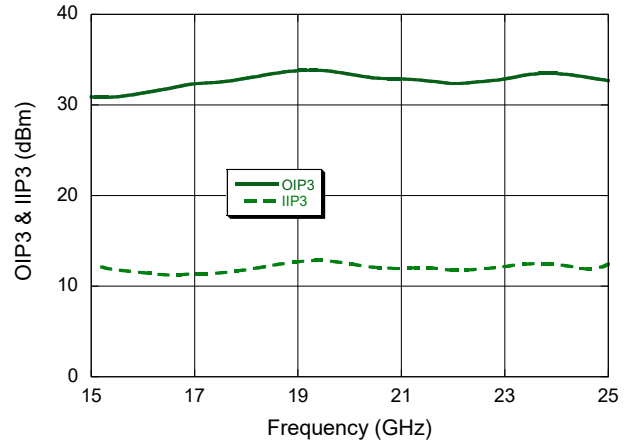

Output P1dB vs. Frequency

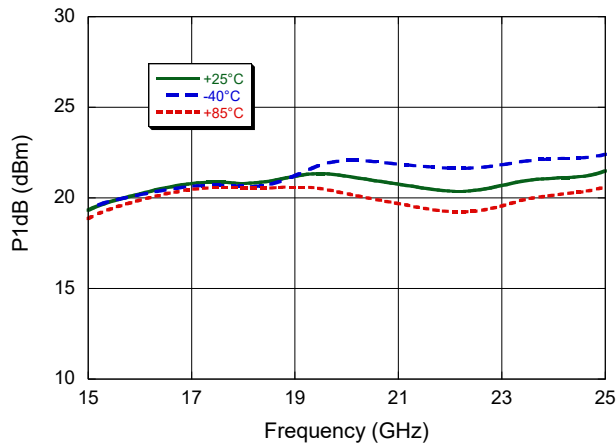

Output IP3 vs. Frequency

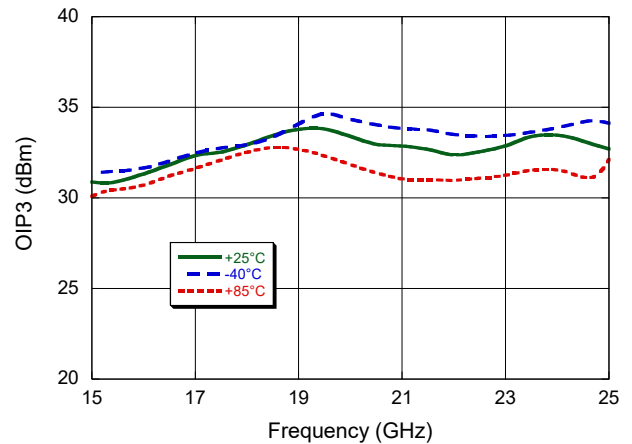

Noise Figure vs. Frequency

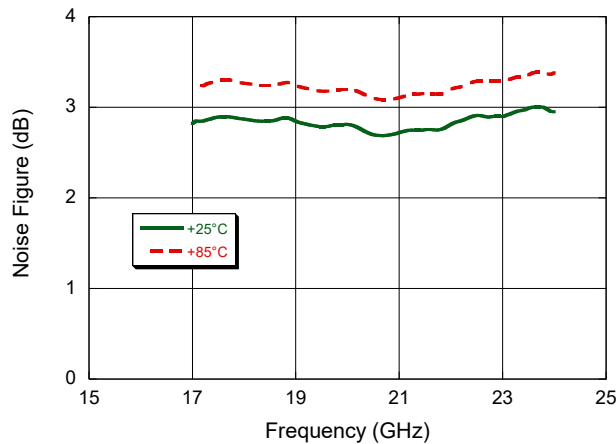

Lead-Free 4 mm 16-Lead PQFN[†]

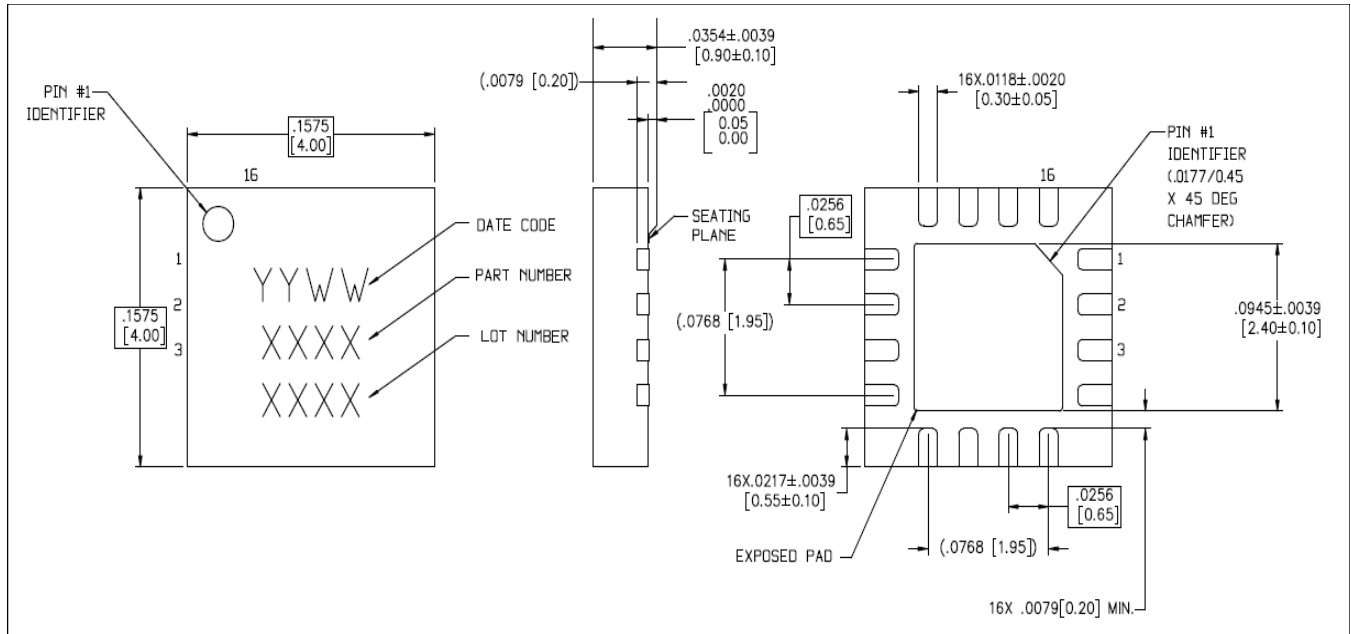

[†] Reference Application Note S2083 for lead-free solder reflow recommendations and PCB footprint information.
Reference JEDEC MO-220,VAR,VGGC for additional dimensional and tolerance information.
Meets JEDEC moisture sensitivity level 1 requirements.
All dimensions shown as in/mm.

MACOM Technology Solutions Inc. ("MACOM"). All rights reserved.

These materials are provided in connection with MACOM's products as a service to its customers and may be used for informational purposes only. Except as provided in its Terms and Conditions of Sale or any separate agreement, MACOM assumes no liability or responsibility whatsoever, including for (i) errors or omissions in these materials; (ii) failure to update these materials; or (iii) conflicts or incompatibilities arising from future changes to specifications and product descriptions, which MACOM may make at any time, without notice. These materials grant no license, express or implied, to any intellectual property rights.

THESE MATERIALS ARE PROVIDED "AS IS" WITH NO WARRANTY OR LIABILITY, EXPRESS OR IMPLIED, RELATING TO SALE AND/OR USE OF MACOM PRODUCTS INCLUDING FITNESS FOR A PARTICULAR PURPOSE, MERCHANTABILITY, INFRINGEMENT OF INTELLECTUAL PROPERTY RIGHT, ACCURACY OR COMPLETENESS, OR SPECIAL, INDIRECT, INCIDENTAL, OR CONSEQUENTIAL DAMAGES WHICH MAY RESULT FROM USE OF THESE MATERIALS.

MACOM products are not intended for use in medical, lifesaving or life sustaining applications. MACOM customers using or selling MACOM products for use in such applications do so at their own risk and agree to fully indemnify MACOM for any damages resulting from such improper use or sale.